

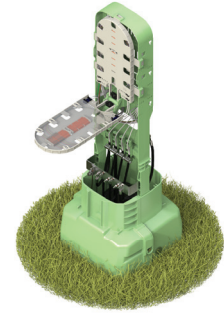

COYOTE® 8" PEDESTAL WITH UNIVERSAL ORGANIZER

INSTALLATION INSTRUCTIONS



IMPORTANT SAFETY INFORMATION

READ AND COMPLETELY UNDERSTAND ALL INSTRUCTIONS BEFORE INSTALLING PRODUCT. FAILURE TO FOLLOW THESE INSTRUCTIONS MAY RESULT IN PERSONAL INJURY OR DEATH.

This product is intended for use by trained technicians only. This product should not be used by anyone who is not familiar with and not trained to use it. When working in the area of energized lines, extra care should be taken to prevent accidental electrical contact. Be sure to wear proper safety equipment per your company protocol. These instructions are not intended to supersede any company construction or safety standards. These instructions are offered only to illustrate safe installation for the individual. PLP products are intended for the specified application only. Do not modify this product under any circumstances. Do not reuse or reinstall any PLP product unless that capability is expressly indicated in the product's Installation Instructions. For proper performance and personal safety, be sure to select the proper PLP product before installation. PLP products are precision devices. To ensure proper performance, they should be stored in cartons under cover and handled carefully.

PACKAGE COMPONENTS

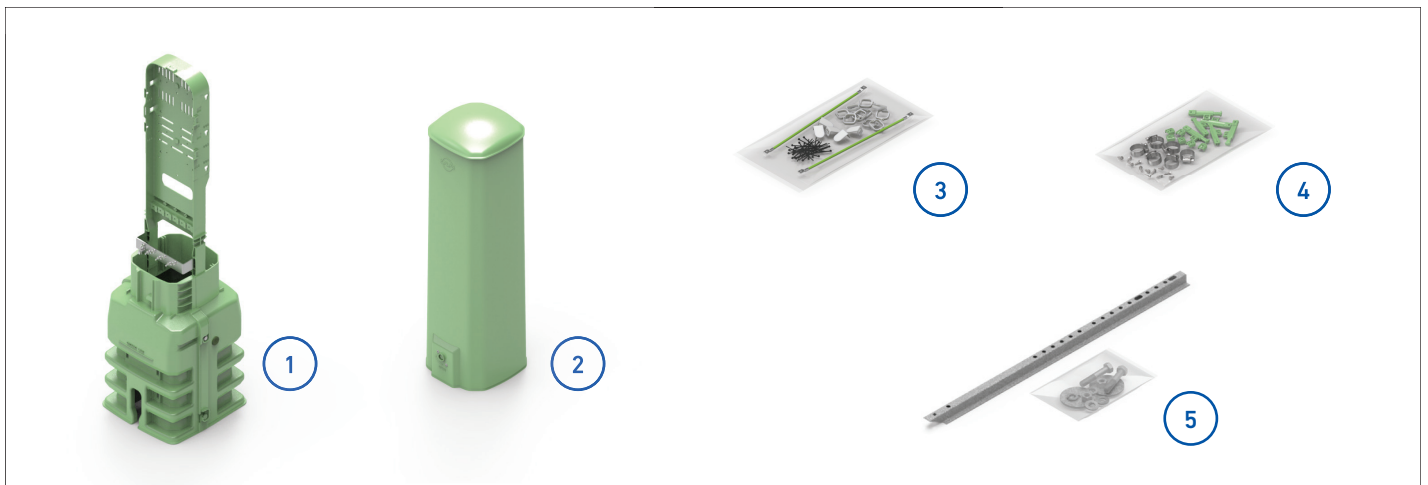

1. COYOTE 8" Pedestal with Universal Organizer and Split Base (1)
2. COYOTE 8" Pedestal Dome (1)
3. Small Parts Bag (1)
4. Cable Restraint Kit (1)
5. Optional - Anchor Stake with Mounting Hardware (1)

Tools Required:

- 3/8" & 7/16" Can Wrench or Socket Wrench
- 1/4" Nut Driver
- Utility Knife
- Side Cutters
- Snips
- Fiber Optic Cable Opening Tools
- Crescent Wrench
- Needle Nose Pliers
- Phillips Head Screwdriver

GROUND PREPARATION

- 1 Prepare trench following your standard company practices. Be careful not to damage any buried cables or wires while digging. Recommended trench size: 20" L x 20" W x 9.5" D (508 x 508 x 241 mm)

NOTE: From the bottom of the base to the ground line is 9.5" (241 mm).

- 2 Verify and establish an earth ground at or near the pedestal base installation site. Place the earth ground following your standard company practices.

- 3 Place cables or conduit in the trench following your standard company practices.



- 4 Prepare a sufficient cable express loop or tail following the table below.



Configuration	Cut Location	Cable Length in (m)
Ground Line to Sheath Opening	A	14" (0.4 m)
Cut or Branch/Drop Cables	B	88" (2.2 m)
Express Cables	C	176" (4.5 m)

PEDESTAL PREPARATION

- 5 Remove the pedestal from the shrink wrap.

NOTE: The shrink wrap should be saved and used as a moisture barrier during the base installation.



- 6 Using a can wrench, turn the hex lock 1/4 turn clockwise. Hold this position and lift the dome from the base.



- 7 The universal organizer is shipped installed in place. To remove the organizer, pull on the tab located on the inside leg and lift slightly. Repeat this process on the second leg to release it from the base.

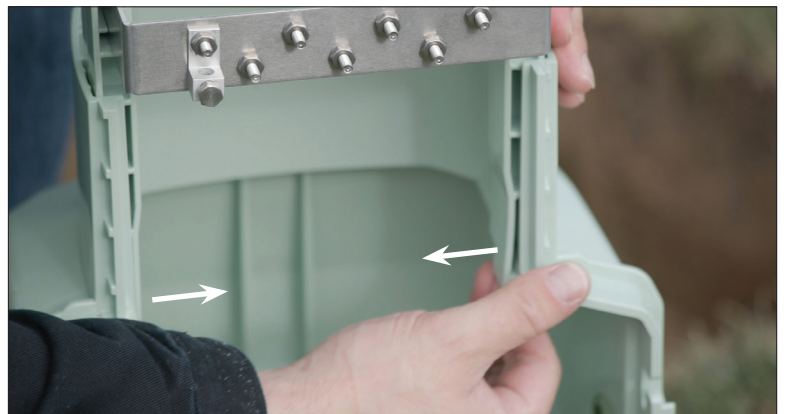

- 8 The split base can be separated by loosening the bolts on each side of the base. These bolts need to be loosened a couple of turns to separate the base halves. Once the bolts are loosened, lift the front half (side of the base with the drop channel) away from the rear half.



ANCHOR STAKE INSTALLATION (IF REQUIRED)

- 9 Using the back half of the base, create an impression in the trench to determine the position of the anchor stake. For harder ground, use a tool to mark the stake location.

NOTE: The base should be installed in the trench so that existing conduits or feed cables are towards the rear of the base.



- 10 The anchor stake will attach to the rear half of the base with the flat edge sitting in the stake channel.



- 11 Install the anchor stake into the trench following your standard company practices. Ensure the anchor stake is level per company practice.



- 12 Attach the rear half of the base to the installed anchor stake using the hardware provided.

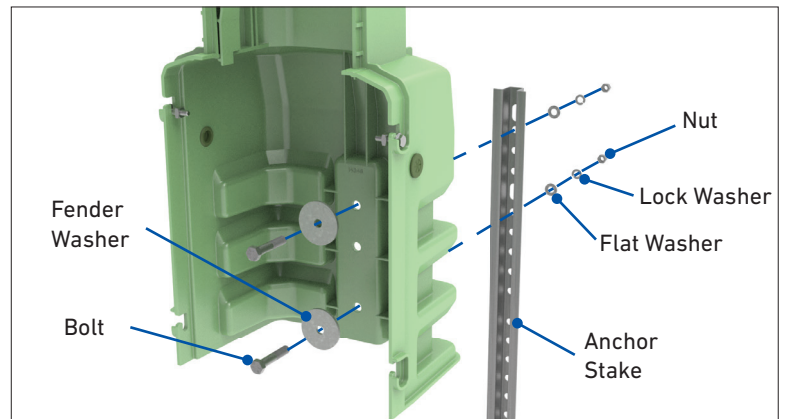

BASE INSTALLATION

- 13 Reinstall the front half of the base by aligning the bottom posts and bolts with the rear half. Tighten the bolts on both sides to secure the halves together.

Ensure the base is level before proceeding.

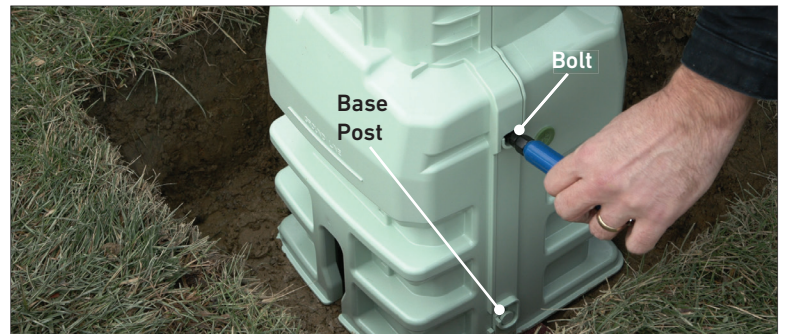

- 14 Cover or plug any conduits in the trench to prevent backfill from filling them.



- 15 Pull the foam plug located inside the drop channel to the top of the channel to prevent backfill from filling it.

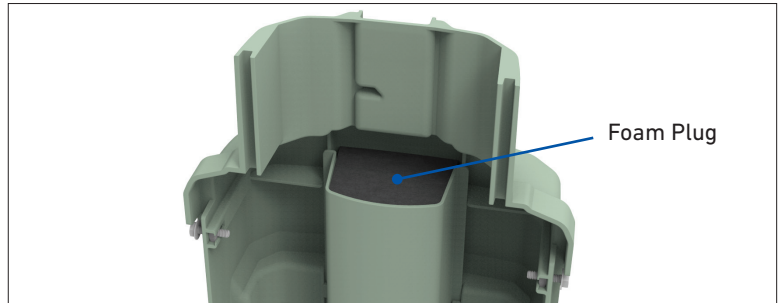

- 16 Add backfill to the base and trench, periodically tamping the soil to remove air from the backfill.

NOTE: It is important to verify that the base is level throughout the installation process.



- 17 Backfill the base and trench following your standard company practices.

- 18 The backfill in the trench outside the base should be level with or above the ground line located on the base.

NOTE: Never mound backfill soil on the outside of the base to make it appear that the base is installed to the recommended depth.

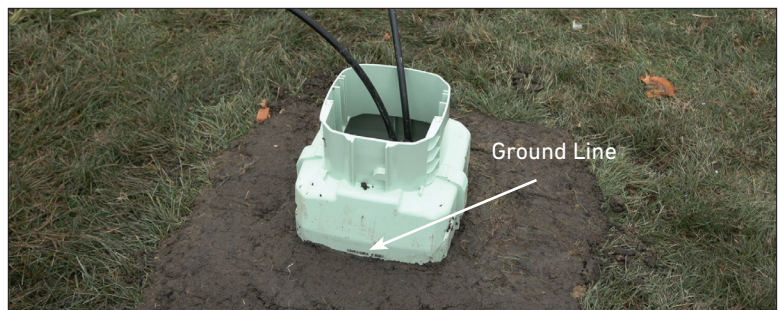

- 19 If you need to straighten the pedestal at any future time never attempt to straighten by pulling, pushing, or manipulating the dome. Remove the soil from around the base and re-adjust the base to re-plumb and straighten a pedestal post-installation. Follow your company standard practices prior to re-adjusting an installed pedestal.

20

Once backfill is at the proper level, install the moisture barrier. The shrink wrap used to package the pedestal can be used as a moisture barrier (recommended size: 12" x 12"). Pour company approved pea gravel on top of the moisture barrier, **DO NOT** accidentally fill any conduits or the drop channel inside the base.

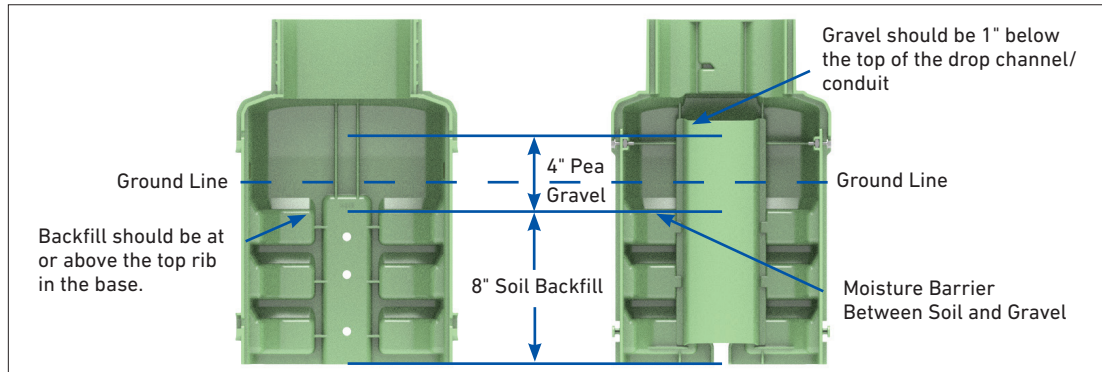

Recommended Backfill Levels Inside the Base

UNIVERSAL ORGANIZER INSTALLATION

21

Reinstall the organizer into the base. Push the organizer into the installed base until two clicks are heard. The organizer can only be installed into the base one way; the busbar should be towards the front of the pedestal.

22

The feed cables should route to the side of the universal organizer near the rear of the base.



- 23 Using the bottom ledge of the cable restraint area, mark the cables to be opened. The universal organizer can be removed from the base to allow for more room for cable preparation.



- 24 Open cables following your standard company practices.
NOTE: Leave about 8" (203 mm) of strength member to trim later.

- 25 If using armored cable, install the shield connector onto the cable as shown. Follow your standard company practices when applying the shield connector to the cable.

NOTE: PLP recommends using a Fiber Optic Shield Connector (**Catalog Number: 80803989**) for shielded cable applications.

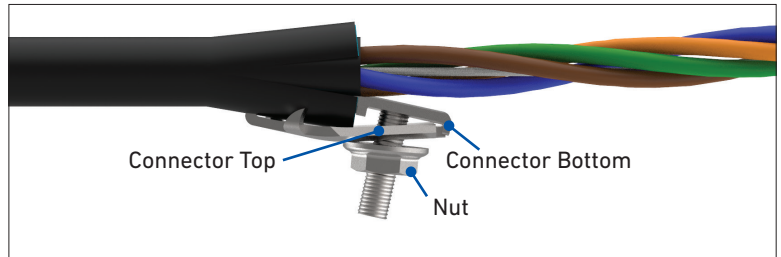

- 26 After the cable is opened, reinstall organizer into base.



- 27 Install a ground wire (#4-#10 AWG) into the lug located on the busbar. Tighten the lug set screw and nut following your standard company practices.

If using crimp connectors remove the lug and attach the crimped connector to the busbar with the nut. Tighten the nut following your standard company practices.

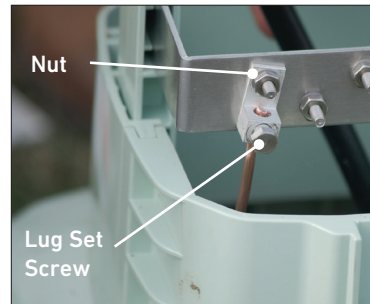

Solid Copper Ground Wire

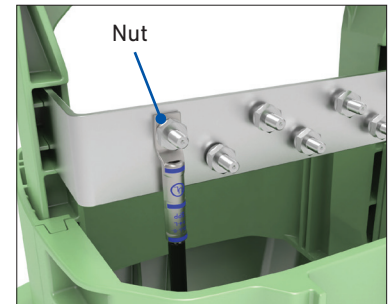

Crimp on Connectors

CABLE PREPARATION

- 28 Remove small parts bag that has been secured to the universal organizer.



- 29 Install the cap on the strength member bracket and loosely secure it to the bracket with the screw provided.

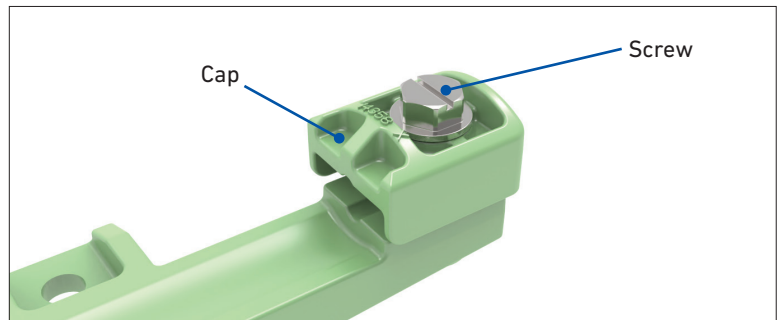

- 30 Align the cable sheath with the screw hole on the strength member bracket. Trim the strength member at the end of the bracket.

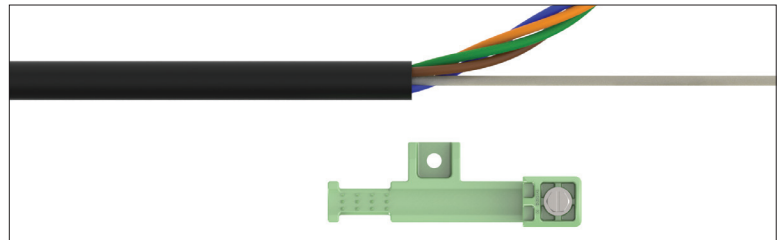

- 31 Position the strength members under the cap of the strength member bracket.

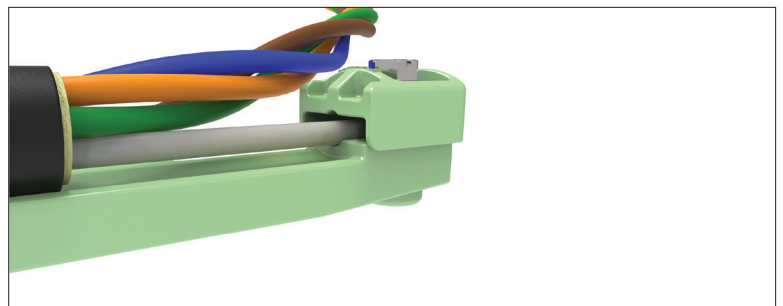

- 32 Tighten the screw of the cap to secure the strength member under the cap.

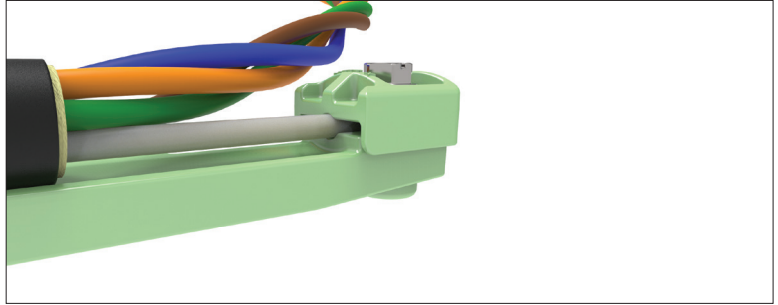

- 33 Secure the cable to the strength member bracket with a hose clamp.

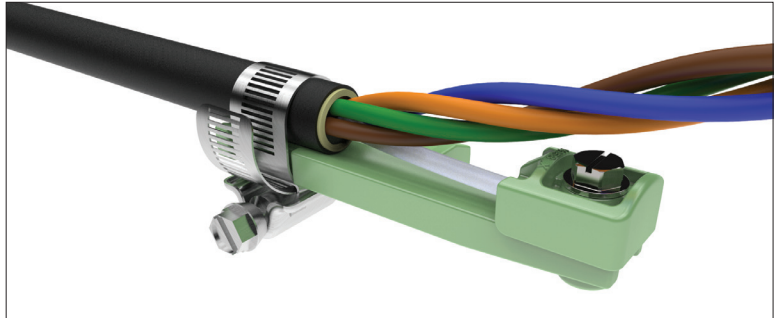

- 34 Align the strength member bracket to the cable restraint area on the organizer and secure the bracket using the screws provided.



- 35 Install bonding braids to the shield connectors installed on the feed cables. Route the bonding braids to the busbar on the drop side of the organizer.

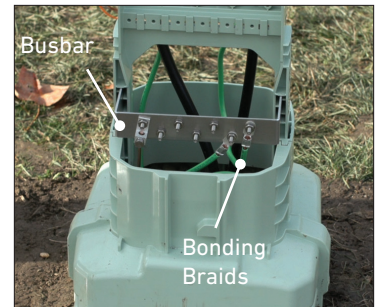
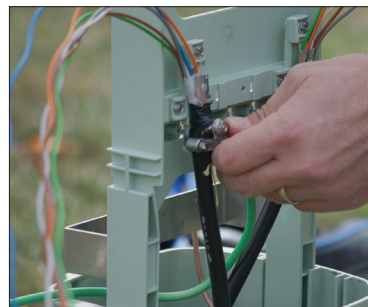

UNIVERSAL ORGANIZER PREPARATION

36

Determine the locations on the feed side to install the routing clips as shown.

Install the routing clips by firmly pressing the clips into the organizer until they click into place.

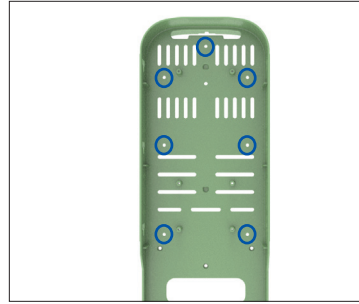
37

Determine the locations on the drop side to install the retention tabs as shown.

Install the retention tabs by pressing the tabs into the pockets until they click into place.

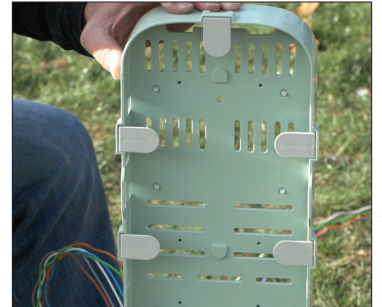
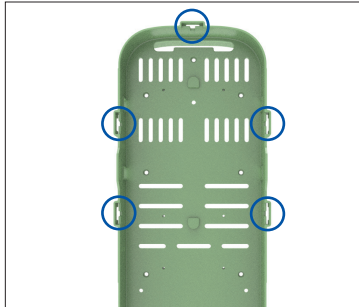
38

Determine the locations on the drop side to install the routing clips near the window cut-out.

Install routing clips by firmly pressing the clips into the organizer until they click into place.

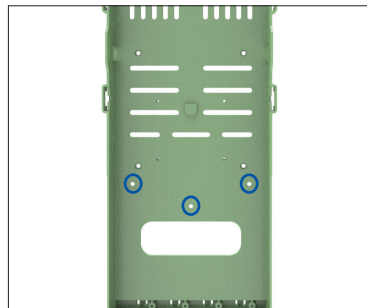

39

Route buffer tubes or fibers to be expressed through the routing clips installed on the organizer as shown.

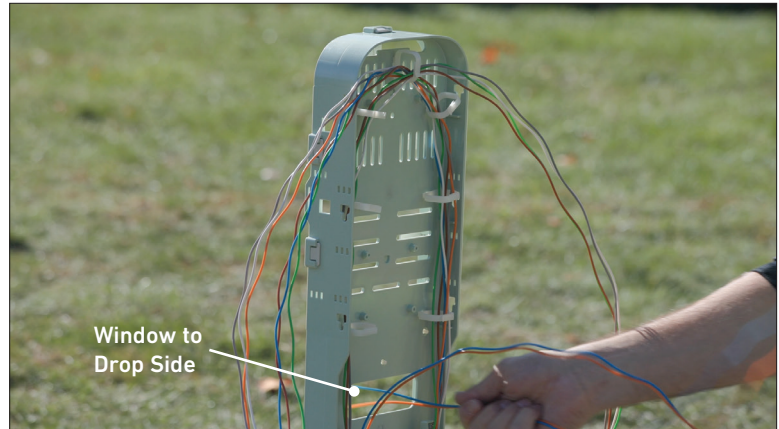

- 40** Route incoming buffer tubes or fibers through the window-cut to the drop side of the organizer.

Any tubes with fibers to be spliced should be passed directly through the window after being secured to the organizer.



- 41** Store any unused tube(s) in the routing clips on the feed side of the organizer.

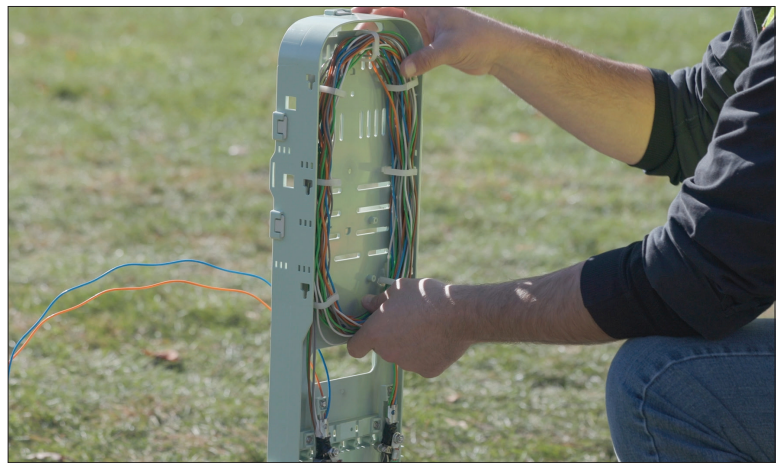

- 42** Store the buffer tube(s) to be spliced under the retention tabs on the drop side of the organizer as shown.

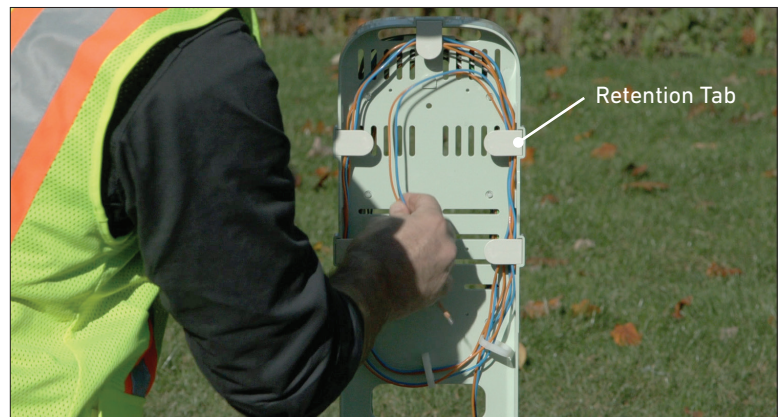

LITE-GRIP® SPLICE TRAY INSTALLATION

43

The LITE-GRIP splice tray kit (**Catalog Number: COYPED8-LGTK**) must be ordered separately and is used in steps 43-49.

Install the storage brackets to the organizer by aligning the brackets with the features in the organizer as shown.

44

Secure the brackets to the organizer using the screws provided.

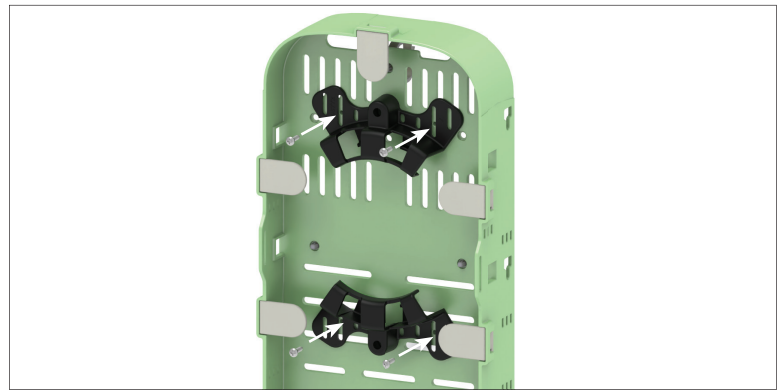
45

Install the splice tray studs into the brackets.

46

Position a LITE-GRIP splice tray on the tray studs.

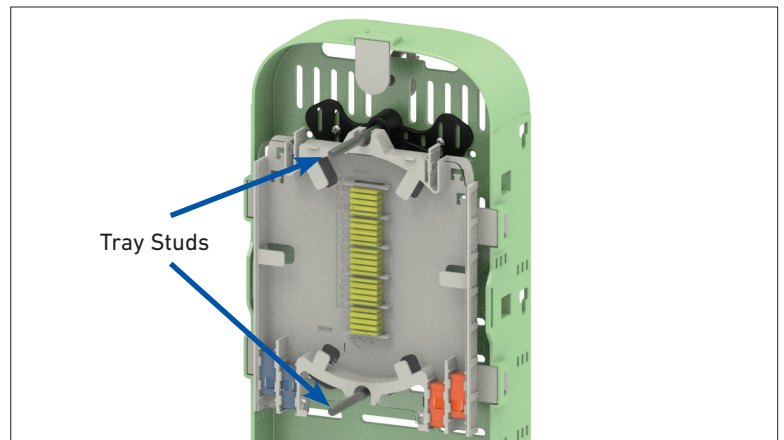

- 47 Route the buffer tube(s) to the splice tray(s) and secure them to the splice tray(s) according to the installation instructions provided with each splice tray.

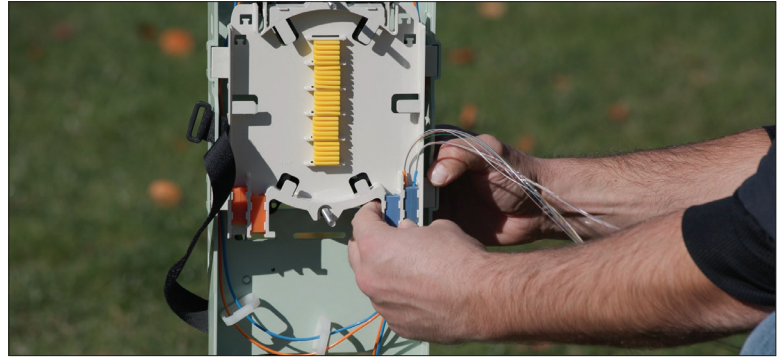

- 48 Route the fibers on the splice tray according to the installation instructions included with the splice tray kit. Splice the fibers according to your standard company practices.

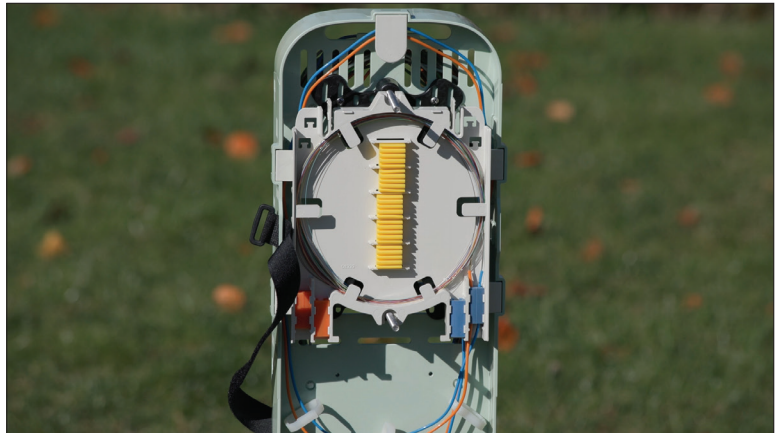

- 49 Secure the splice tray(s) to the organizer with the hold down strap.

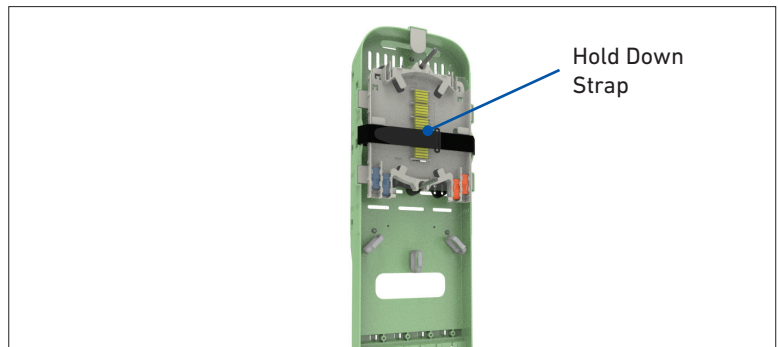

- 50 For fiber splicing with flip trays (**Catalog Number: COYPED8-FLIPTK**), follow the installation instructions provided with the tray kit.

DROP CABLE INSTALLATION

- 51** The front half of the split base has a drop channel to allow for easier installation of drop cables once the pedestal has been installed.

The drop channel comes with a foam plug pre-installed.

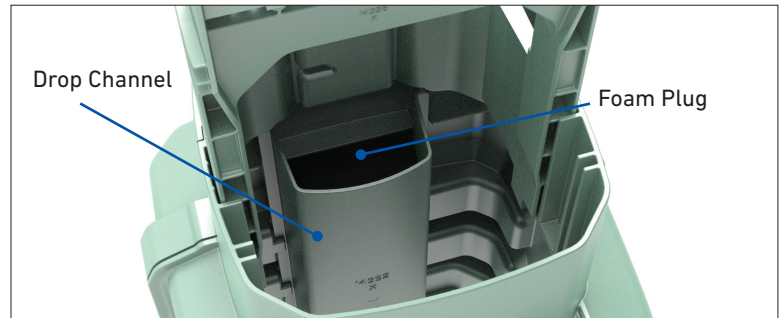

- 52** The drop channel is held in position with four tabs. Squeeze the drop channel to release it from the two tabs on one side then the other side.



- 53** Dig a small trench to access the drop channel (roughly 7.5" below ground level).

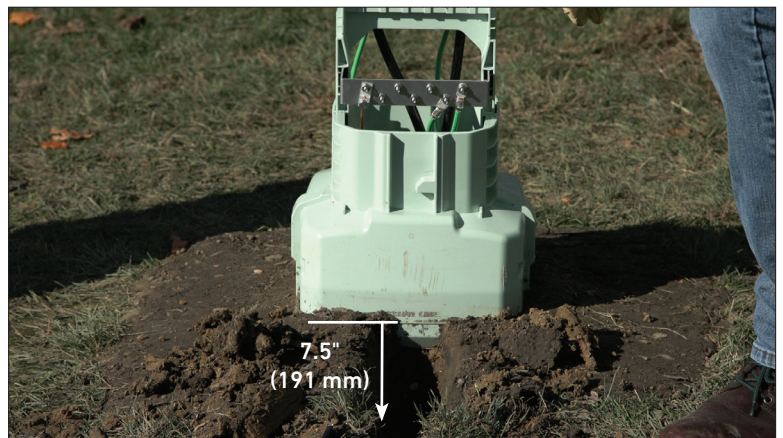

- 54** Push drop into the drop channel and through the foam plug. The foam can be removed and slit prior to installing the drop.

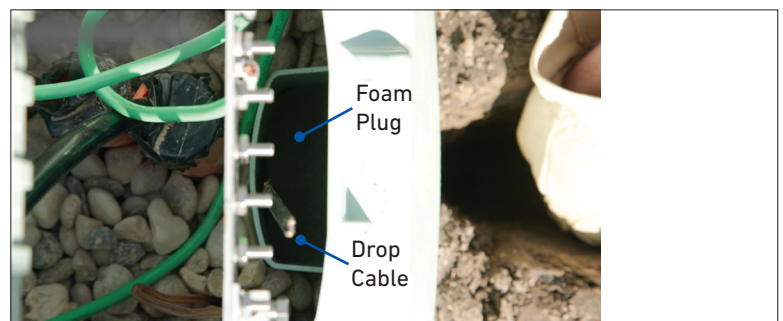

- 55** Prepare cable(s) for cable end applications. Refer to the table for the minimum sheath openings for the pedestal.

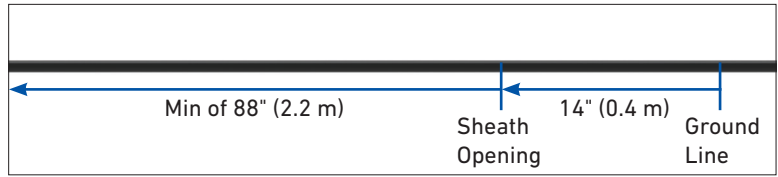

Configuration	Cable Length in (m)
Ground Line to Sheath Opening	14" (0.4 m)
Sheath Opening – Cut End	88" (2.2 m)

- 56** Install drop and branch cables to universal organizer following step 25 (if armored cable is being used) and steps 29-34 for cable restraint.

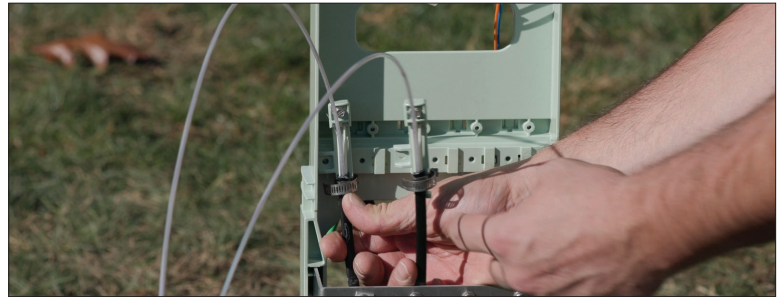

- 57** Route drop cables to the splice tray(s).

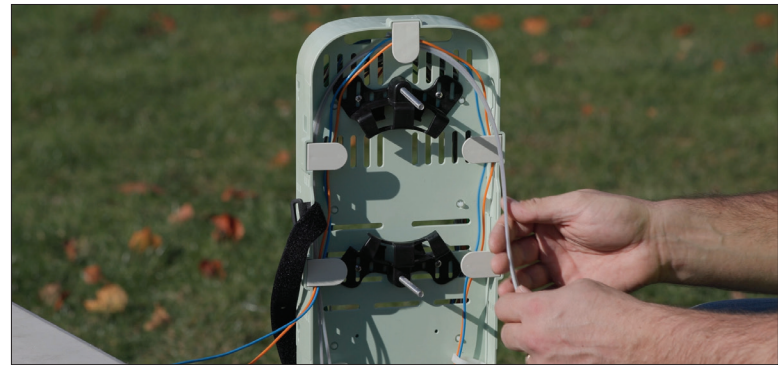

- 58** Route the fibers on the splice tray according to the installation instructions included with the splice tray kit. Splice the fibers according to your standard company practices.

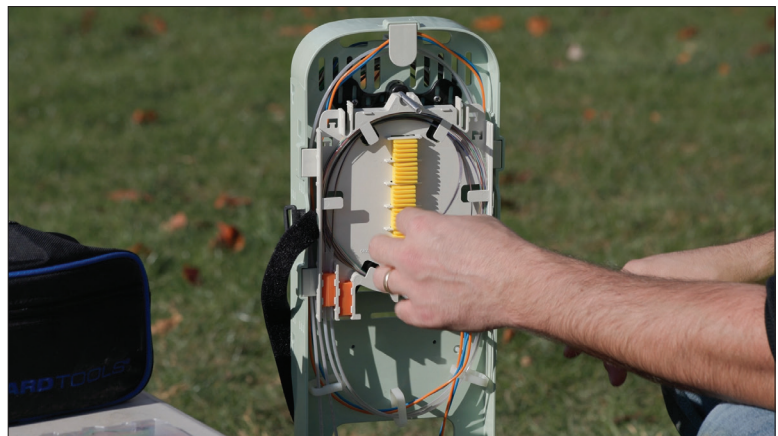

- 59 Secure the splice tray(s) to the organizer using the hold down strap.

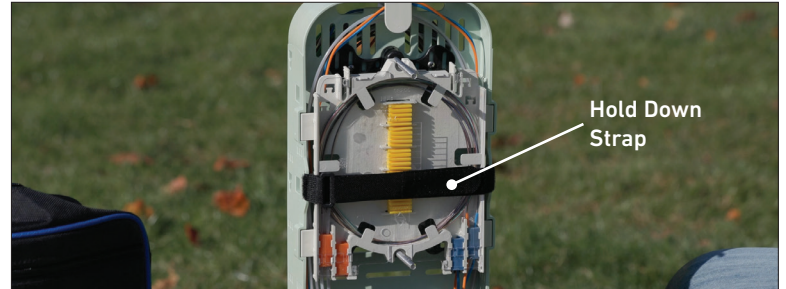

- 60 Once all splicing has been completed, re-install the dome onto the base. The automatic lock on the dome will engage with the base once installed.

NOTE: Pull up on the dome to ensure that the lock has properly engaged with the split base.



APPENDIX A

COYOTE® Splice Tray Capacity Chart for COYOTE 8" Pedestal

PLP Catalog Number	Description	Image	Splice Type	Max Trays per Closure	Closure Max Splice Capacity
80809958	LITE-GRIP® Short Low Profile (24 CT)		Single Fusion (Single Stack)	6	144
80813152	LITE-GRIP® Short Low Profile (36 CT)		Single Fusion (Single Stack)	6	216
80808945	LITE-GRIP® Short Deep Profile (40 CT)		Single Fusion (Double Stack)	3	120
LGSTR144	LITE-GRIP® Short Deep Profile (144 CT)		Mass Fusion/ Ribbon	3	432
80814405	Flip Thin Profile (72 CT SF / 144 CT MF)		Single Fusion (Double Stack) OR Mass Fusion/ Ribbon	4	288 SF 288 MF
80814406	Flip Deep Profile (72 CT SF / 288 CT MF)		Single Fusion (Double Stack) OR Mass Fusion/ Ribbon	2	144 SF 576 MF

APPENDIX B

COYOTE 8" Pedestal Kits

PLP Catalog Number	Description
COYPED8-UOS	COYOTE 8" Pedestal, Universal Organizer with Anchor Stake – Includes (1) 8" Pedestal, Universal Organizer with Busbar and Split Base, (1) Dome, (1) Small Parts Bag, (1) Cable Retention Kit, and (1) Anchor Stake with Attachment Hardware
COYPED8-UON	COYOTE 8" Pedestal, Universal Organizer without Anchor Stake – Includes (1) 8" Pedestal, Universal Organizer with Busbar and Split Base, (1) Dome, (1) Small Parts Bag, and (1) Cable Retention Kit
COYPED8-MBPS	COYOTE 8" Pedestal, Metal Back Plane with Anchor Stake – Includes (1) 8" Pedestal, Metal Back Plane and Split Base, (1) Dome, and (1) Anchor Stake with Attachment Hardware
COYPED8-MBPN	COYOTE 8" Pedestal, Metal Back Plane without Anchor Stake – Includes (1) 8" Pedestal, Metal Back Plane and Split Base, and (1) Dome

APPENDIX C

Accessory Kits for COYOTE® 8" Pedestal

PLP Catalog Number	Description
COYPED8-FLIPTK	Flip Tray Installation Kit for 8" Pedestal
COYPED8-LGTK	LITE-GRIP® Tray Installation Kit for 8" Pedestal
COYPED8-IXC	Internal Cross-Connect Kit – Includes (1) Cross-Connect Organizer and (2) 24 Ct. Splice Trays
COYPED8-CWH	Copper Waterfall Handle Kit for 8" Pedestal – Includes (3) Routing Handles
COYPED810-TM	Terminal Mounting Bracket Kit for 8" and 10" Pedestals
COYPED8-GRDPLT	Grounding Plate Kit for 8" Pedestal – Includes (1) Ground Plate Assembly and (1) Bonding Braid
COYPED8-BASE	8" Base Replacement Kit
COYPED8-DOME	8" Dome Replacement Kit

APPENDIX D

Accessory Kits for COYOTE® Pedestals

PLP Catalog Number	Description
COYPED-BLKHD12P	Standard Cross-Connect Bulkhead Kit – Accepts up to 6 Duplex SC or 6 Quad LC Flangeless Adapters
COYPED-BLKHD24P	Deep Cross-Connect Bulkhead Kit – Accepts up to 12 Duplex SC or 12 Quad LC Flangeless Adapters
COYPED-CRB	Cable Restraint Bracket Kit – Includes (20) Strength Member Brackets, (20) Strength Member Bracket Caps, (20) Hose Clamps, and (40) Hex Head Self-Tapping Screws
COYPED-BNDBRD	Bonding Braid Kit – Includes (20) Bonding Braids
COYPED-DRPCHNL	Drop Channel Kit – Includes (1) Drop Channel and (1) Foam Plug
COYPED-DRPGMT	Base Drop Grommet Kit – Includes (20) Base Drop Grommets
COYPED-FBRCLIP	Fiber Cable Management Clip Kit – Includes (10) Fiber Routing Clips
COYPED-FBRTAB	Retention Tab Kit – Includes (50) Retention Tabs
COYPED-AS42	Anchor Stake Kit – Includes (1) 42" Anchor Stake and Mounting Hardware



GLOBAL HEADQUARTERS
660 BETA DRIVE
CLEVELAND, OH 44143

+1 440 461 5200
INFO@PLP.COM
PLP.COM