

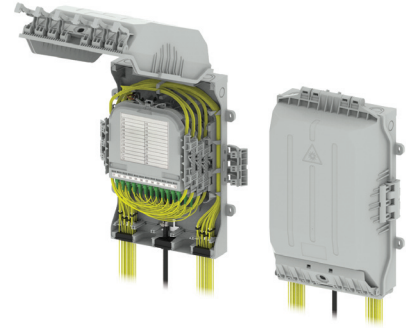

# COYOTE® DEN5 WALL BOX

## INSTALLATION INSTRUCTIONS



### IMPORTANT SAFETY INFORMATION

**READ AND COMPLETELY UNDERSTAND ALL INSTRUCTIONS BEFORE INSTALLING PRODUCT. FAILURE TO FOLLOW THESE INSTRUCTIONS MAY RESULT IN PERSONAL INJURY OR DEATH.**

This product is intended for use by trained technicians only. This product should not be used by anyone who is not familiar with and not trained to use it. When working in the area of energized lines, extra care should be taken to prevent accidental electrical contact. Be sure to wear proper safety equipment per your company protocol. These instructions are not intended to supersede any company construction or safety standards. These instructions are offered only to illustrate safe installation for the individual. PLP products are intended for the specified application only. Do not modify this product under any circumstances. Do not reuse or reinstall any PLP product unless that capability is expressly indicated in the product's Installation Instructions. For proper performance and personal safety, be sure to select the proper PLP product before installation. PLP products are precision devices. To ensure proper performance, they should be stored in cartons under cover and handled carefully.

### PACKAGE COMPONENTS FOR COYOTE DEN5 WALL BOX SPLICE ONLY

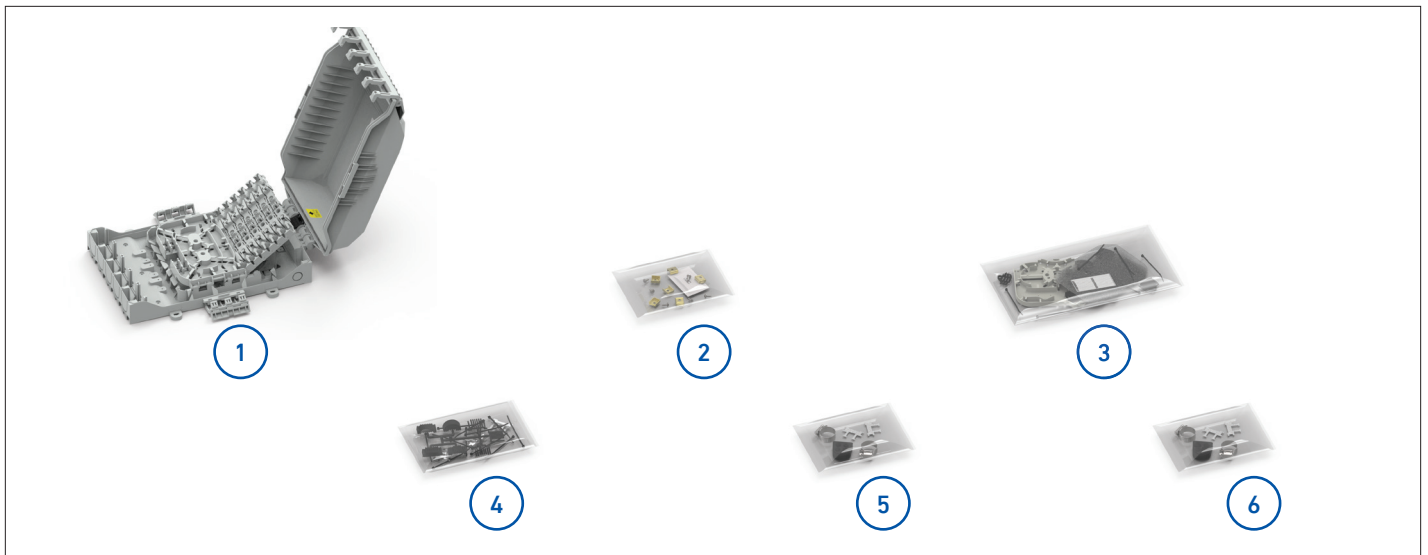

1. COYOTE DEN5 Cover & Base with Splice Only Organizer and FibeRoad™ Hinged Splice Tray Manager (1)
2. Small Parts Bag (1)
3. COYOTE DEN 24 CT. Deep Profile Flip Splice Tray Kit (4)
4. 24-Hole Grommet Kit - Contains 1 Grommet (2)  
(0.07" – 0.12" Cable Diameter Range)
5. 4-Hole Grommet Kit - Contains 1 Grommet (1)  
(0.30" – 0.38" Cable Diameter Range)
6. 4-Hole Grommet Kit - Contains 1 Grommet (1)  
(2 Holes: 0.38" – 0.46" Cable Diameter Range,  
2 Holes: 0.46" – 0.51" Cable Diameter Range)

#### Tools Required:

- Phillips Head Screwdriver
- Utility Knife
- Side Cutters
- Needle Nose Pliers
- Snips
- Fiber Optic Cable Opening Tools
- Flat Head Screwdriver

For additional components and accessories, see Appendix.

FibeRoad™ System is a trademark of PLP-Micos.

## PACKAGE COMPONENTS FOR COYOTE DEN5 WALL BOX

CROSS-CONNECT WITH 2 CASSETTES

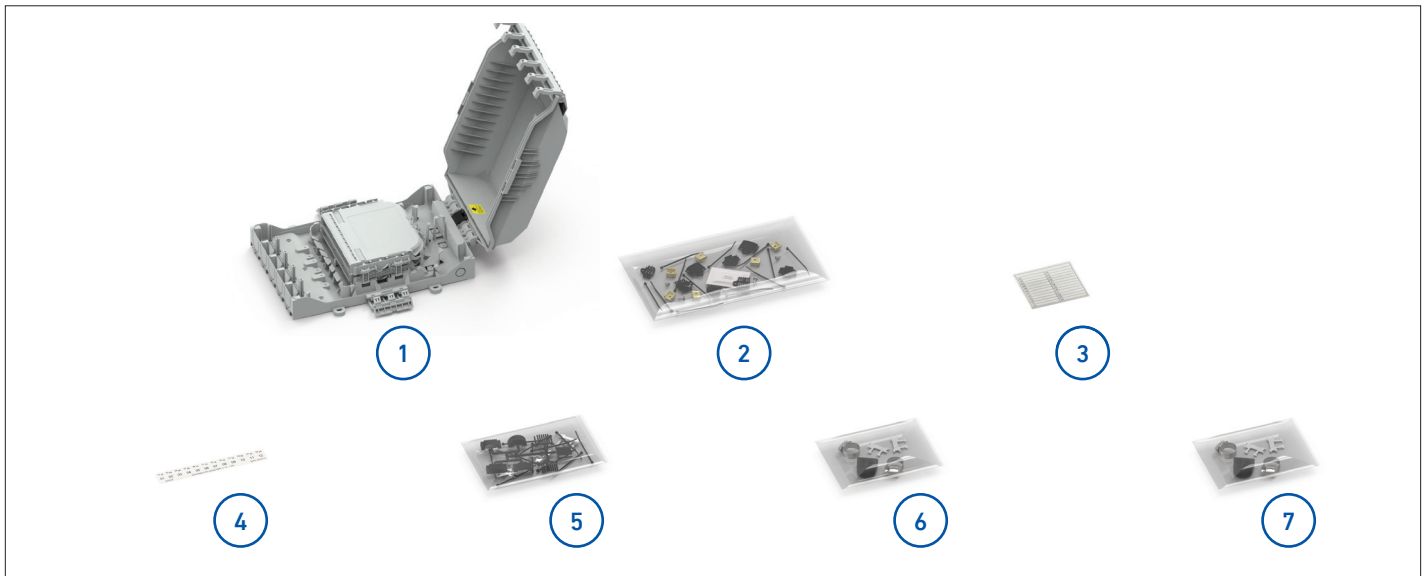

1. COYOTE DEN5 Cover & Base with Cross-Connect Organizer and 2 Pre-Installed Cassettes (1)
2. Small Parts Bag (1)
3. Cassette Splice Location Label (2)
4. Cassette Connector Location Label (2)
5. 24-Hole Grommet Kit - Contains 1 Grommet (2) (0.07" – 0.12" Cable Diameter Range)
6. 4-Hole Grommet Kit - Contains 1 Grommet (1) (0.30" – 0.38" Cable Diameter Range)
7. 4-Hole Grommet Kit - Contains 1 Grommet (1) (2 Holes: 0.38" – 0.46" Cable Diameter Range, 2 Holes: 0.46" – 0.51" Cable Diameter Range)

### Tools Required:

- Phillips Head Screwdriver
- Utility Knife
- Side Cutters
- Pliers
- Snips
- Fiber Optic Cable Opening Tools
- Flat Head Screwdriver

## PACKAGE COMPONENTS FOR COYOTE DEN5 WALL BOX

CROSS-CONNECT WITH 4 CASSETTES

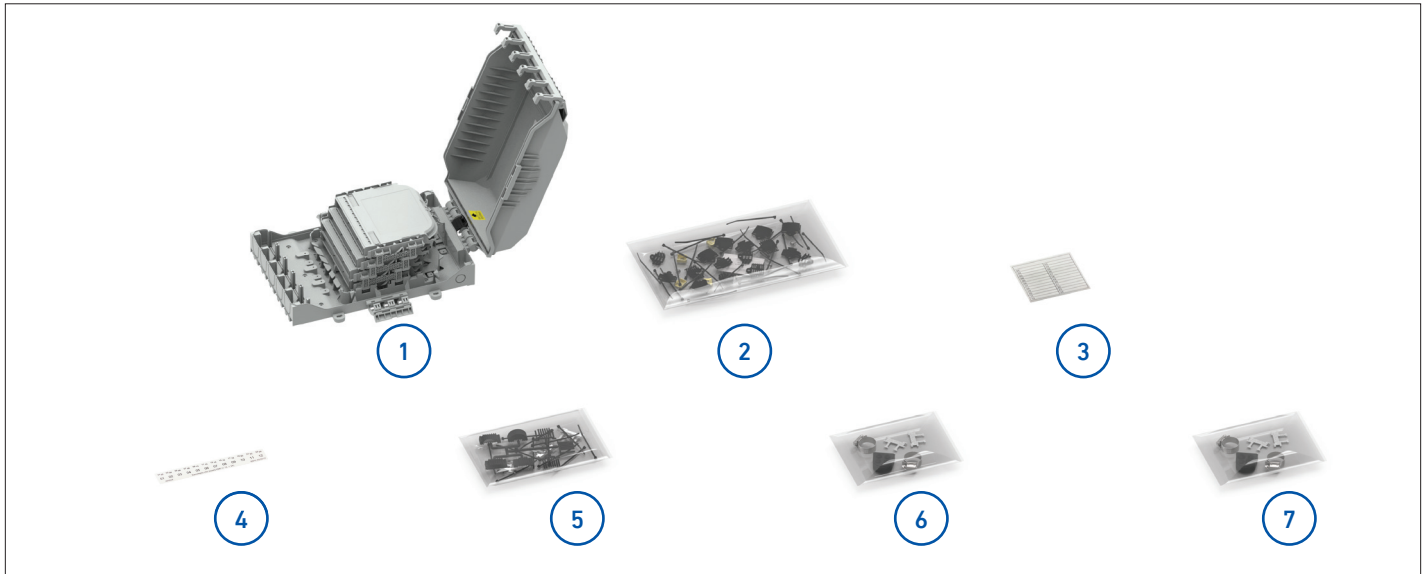

1. COYOTE DEN5 Cover & Base with Cross-Connect Organizer and 4 Pre-Installed Cassettes (1)
2. Small Parts Bag (1)
3. Cassette Splice Location Label (4)
4. Cassette Connector Location Label (4)
5. 24-Hole Grommet Kit - Contains 1 Grommet (2)  
(0.07" – 0.12" Cable Diameter Range)
6. 4-Hole Grommet Kit - Contains 1 Grommet (1)  
(0.30" – 0.38" Cable Diameter Range)
7. 4-Hole Grommet Kit - Contains 1 Grommet (1)  
(2 Holes: 0.38" – 0.46" Cable Diameter Range,  
2 Holes: 0.46" – 0.51" Cable Diameter Range)

### Tools Required:

- Phillips Head Screwdriver
- Utility Knife
- Side Cutters
- Pliers
- Snips
- Fiber Optic Cable Opening Tools
- Flat Head Screwdriver

## WALL BOX PREPARATION

- 1 Hinge the flaps of the side latches down to unlatch the sides of the cover from the base.

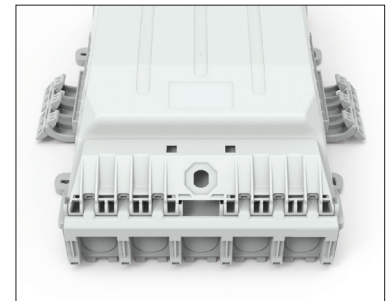
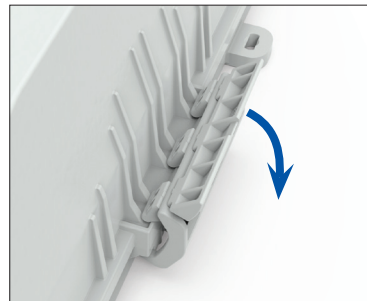

- 2 Pull the flap portion of the front latch down to disengage the portion under the base and hinge the cover open.

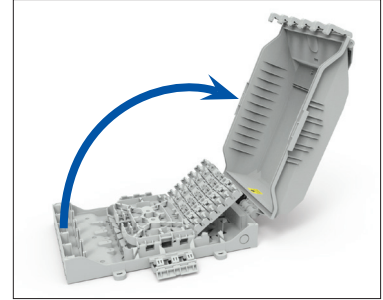
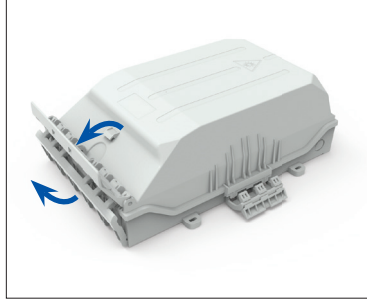

- 3 Determine which cable entry ports will be used and score each chosen port with a utility knife. Snip each edge of the breakout tab with side cutters.

**NOTE:** Score each cable entry port a few times for best results.

**NOTE:** Ports 1 and 5 cannot be used with cables where strength members need restrained.

**⚠ WARNING**

Always score the cable entry ports with the utility knife angled away from your body. Not doing so can lead to physical injury.

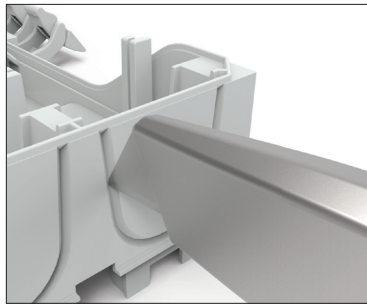

Scoring Cable Entry Port

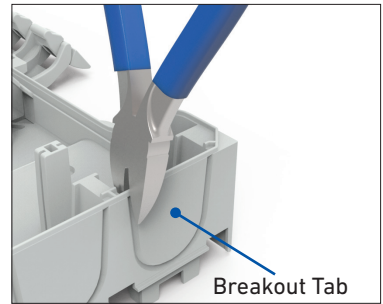

Snipping Edge of Breakout Tab

- 4 Remove each breakout tab by pulling the tab outwards from the base with pliers. Once the tabs have been removed, smooth out the remaining material of the cable entry ports with a utility knife.

**⚠ WARNING**

Always remove jagged cable entry port edges with the utility knife angled away from your body. Not doing so can lead to physical injury.

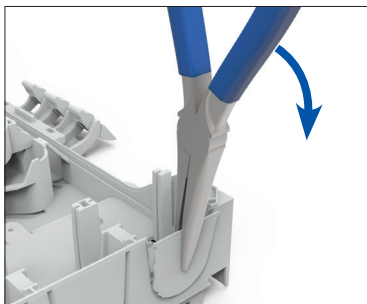

Removing Breakout Tab

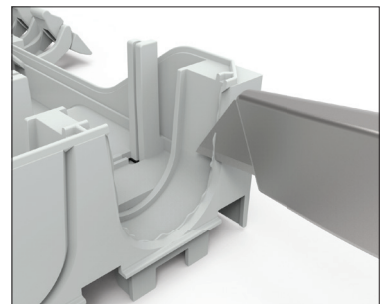

Removing Jagged Cable Port Edges

## WALL MOUNT INSTALLATION

- 5 Place the wall box against the wall at the desired location and secure the box by the mounting tabs with either 3/16" (5 mm) screws or bolts (not provided).

**NOTE:** If the box is being mounted to a cement or brick wall, mark the wall where the mounting tabs are located. Drill holes into the wall at the marked locations. Insert the appropriate anchors (not provided) into the holes for the 3/16" (5 mm) screws or bolts (not provided) that are being used to mount the box to the wall. Insert the screws or bolts through the mounting tabs of the wall box and secure the wall box to the wall.

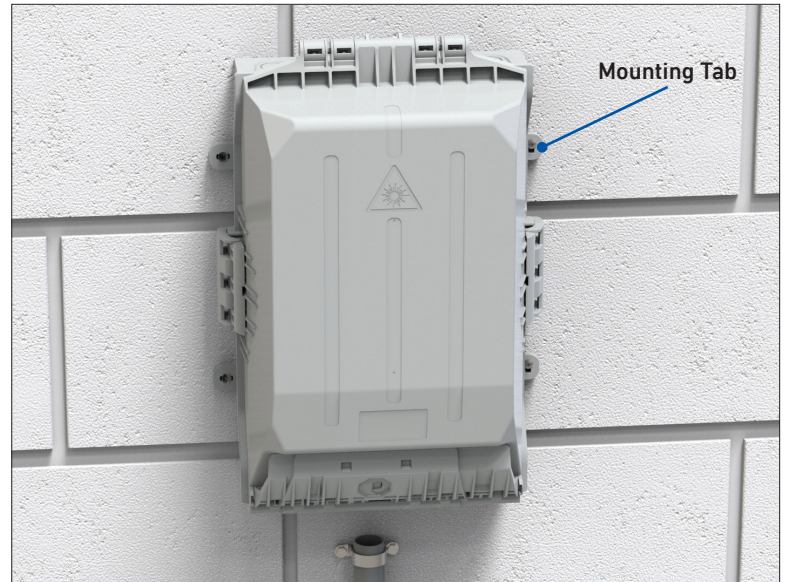

## INSTALLING CABLES INTO 4-HOLE, 8-HOLE, OR 12-HOLE GROMMETS

- 6 Measure the cable to determine the diameter and hole location to use in the grommet.



- 7 If using cut cable, puncture the grommet with the cable or use a tool to puncture the grommet prior to inserting the cable.

**NOTE:** Insert cables in the bottom holes of the grommet first.

**NOTE:** If your application requires express/balloon/ring cut cables, see Steps 8 and 9 for grommet slitting and cable installation procedure.

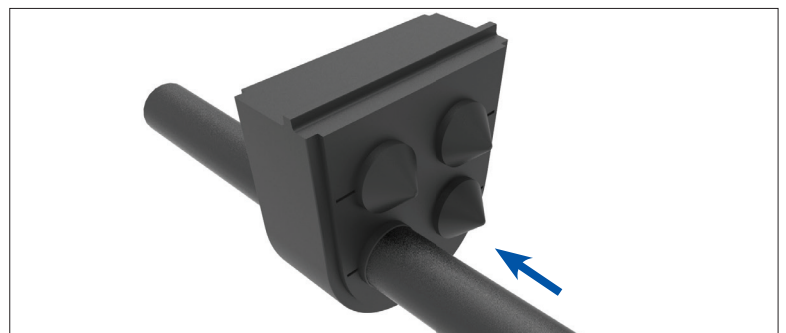

- 8 To slit grommets for expressed/balloon/ring cut cable applications, cut the grommet at the slit lines using snips as shown.

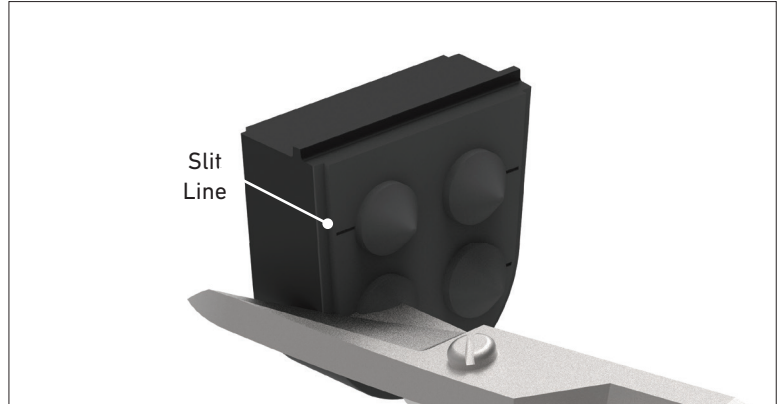

- 9 Insert the cable into the grommet through the slit.

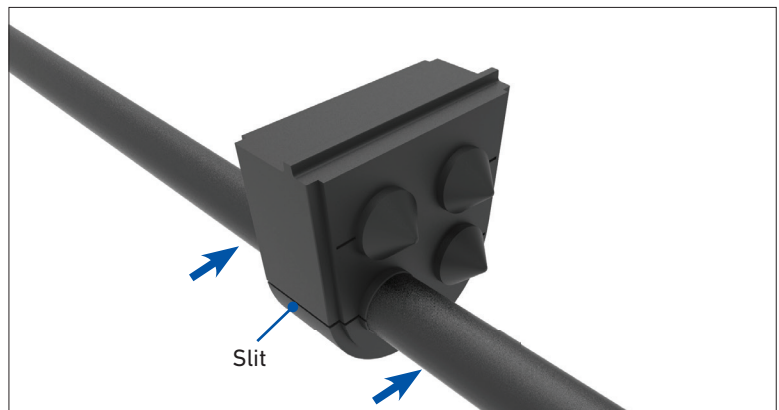

## INSTALLING CABLE INTO 24-HOLE GROMMET

- 10 Measure the cable to verify the diameter.



**11**

Use the image shown as a guide on how to assemble the grommet. Determine which holes the cables will be placed in the grommet starting from the bottom and remove the appropriate plugs from each plug set with snips. Place the cables and plugs into the appropriate slots of the grommet sections and stack the grommet sections together.

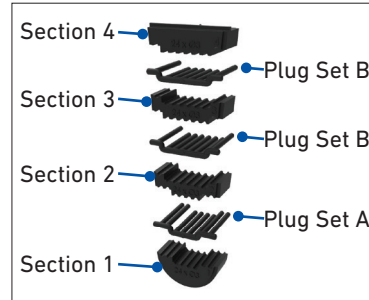

24-Hole Grommet Assembly

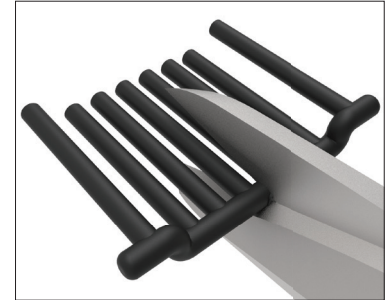

Removing Grommet Plugs From Set



Installing Cables and Plugs into 24-Hole Grommet



Assembled 24-Hole Grommet

## CABLE SHEATH OPENINGS FOR CUT CABLE END APPLICATIONS

**12**

Prepare cable(s) for cable end applications. Refer to the table to the right for the minimum sheath openings allowed for each organizer.

**NOTE:** Leave roughly 8" (203 mm) of the cable strength member(s) to trim later.

### CAUTION

Follow the cable manufacturer's cable opening procedure to ensure the optical fibers of the cable are not cut or damaged.



Buffer Tube/Loose Tube Cable

**Minimum Sheath Openings for Cable End Applications**

Cable Side	Feed		Branch/Drop	
	in	m	in	m
Direct Splice	89	2.26	89	2.26
Cross-Connect	85	2.16	85	2.16

## CABLE SHEATH OPENINGS

FOR EXPRESSED CABLE APPLICATIONS WITH DEDICATED CUT FIBERS

- 13** Prepare the cable for mid cable span applications (express/balloon/ring cut cable applications). Refer to the table to the right for the minimum sheath openings allowed for each organizer.

**NOTE:** For buffer tube/loose tube cables, the center of the sheath opening should align with the center of a buffer tube/loose tube switchback point of the cable.

**NOTE:** Leave roughly 8" (203 mm) of the cable strength member(s) to trim later.

**NOTE:** For splice points where optical fibers are dedicated to the splice point, only allow the Office/C.O. side of the cut fibers to be spliced. The other side of the cut fibers will be dead for the remainder of the cable network.

### CAUTION

Follow the cable manufacturer's cable opening procedure to ensure the optical fibers of the cable are not cut or damaged.

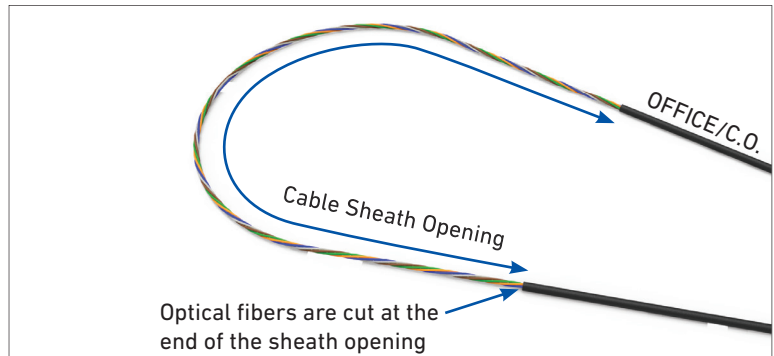

Buffer Tube/Loose Tube Cable

Minimum Sheath Openings for Applications Where Fiber is Dedicated to the Splice Point				
Cable Side	Feed		Branch/Drop	
	in	m	in	m
Direct Splice	89	2.26	89	2.26
Cross-Connect	85	2.16	85	2.16

## CABLE PREPARATION FOR CABLES WITH ARAMID YARN

- 14** If the cable contains aramid yarn, braid roughly 3" (0.08 m) of the aramid yarn.

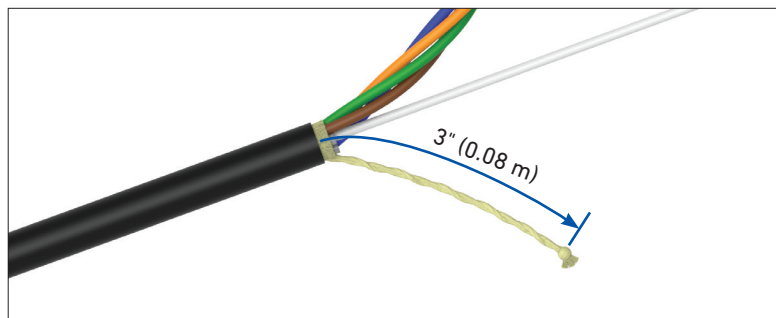

## INSTALLING CABLE RESTRAINT BRACKETS ONTO ROUND CABLES

- 15** Adjust the cable(s) in the grommet so the cable sheath opening is the measured distance away from the face of the grommet as shown.

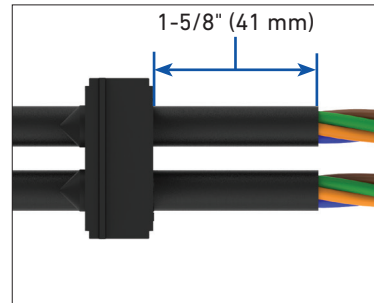

2-Leg Cable Restraint Bracket

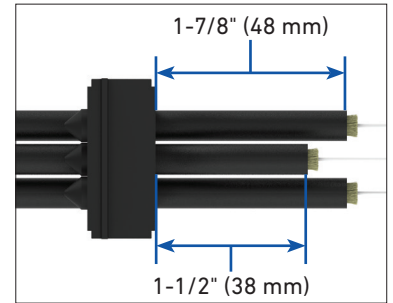

3-Leg Cable Restraint Bracket

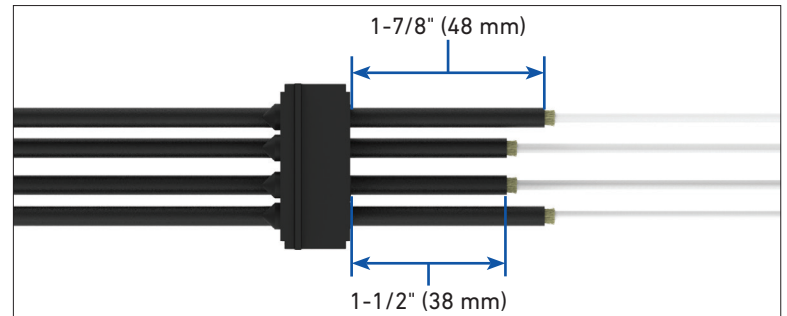

4-Leg Cable Restraint Bracket

- 16** Align the cable sheath opening of each cable with the ends of the legs of the cable restraint bracket(s).

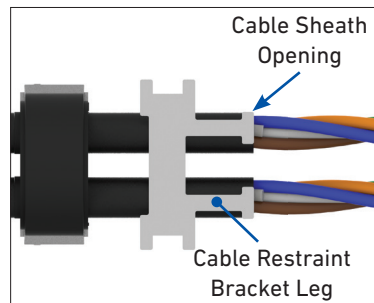

2-Leg Cable Restraint Bracket

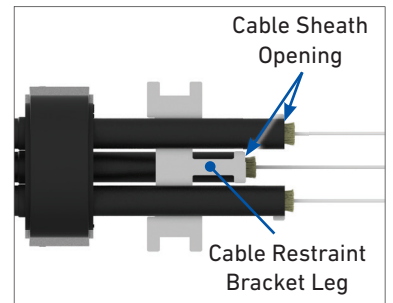

3-Leg Cable Restraint Bracket

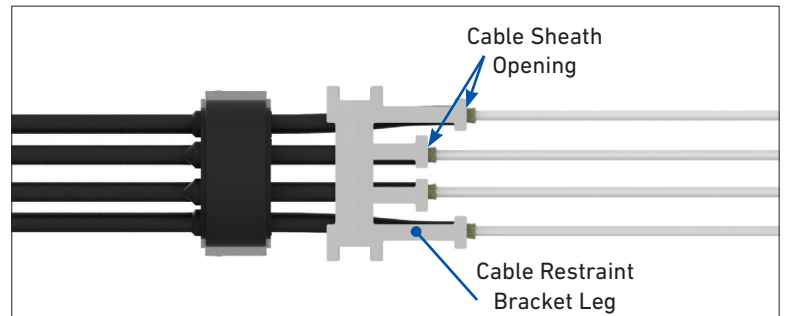

4-Leg Cable Restraint Bracket

- 17** Secure the cables to the legs of the cable restraint bracket(s) with the hose clamps or cable tie wraps that were provided in the grommet kit as shown.

**NOTE:** Make sure the placement of the heads of the hose clamps or cable tie wraps are positioned as shown.

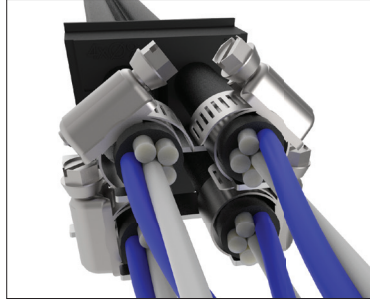

4-Hole Grommet

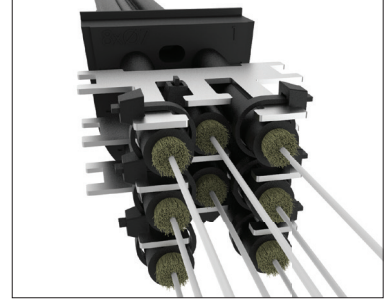

8-Hole Grommet

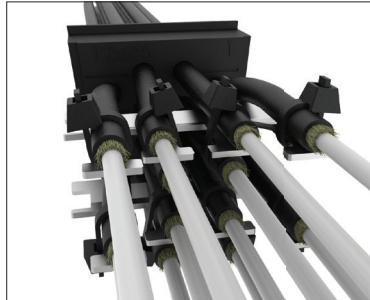

12-Hole Grommet

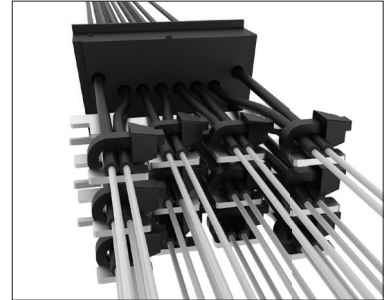

24-Hole Grommet  
The 24-Hole Grommet will have 2 cables for every bracket leg.

## INSTALLING CABLE RETENTION CLIP ONTO FLAT DROP CABLES

- 18** Trim the cable strength members as close to the cable sheath opening as possible.



- 19 Adjust the cable(s) in the grommet so the cable sheath opening is 1-5/8" (41 mm) away from the face of the grommet.

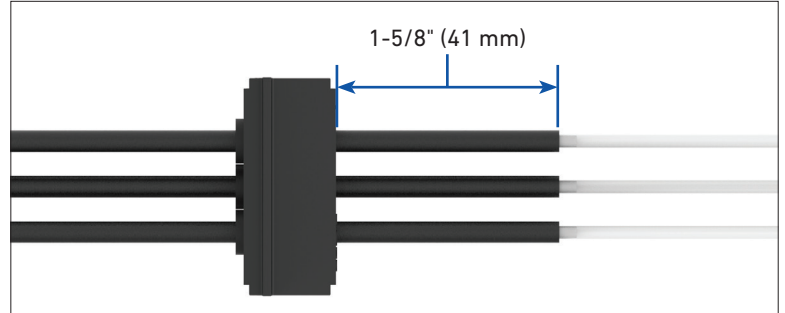

- 20 Place a mark on each cable 3/4" (19 mm) away from the face of the grommet.

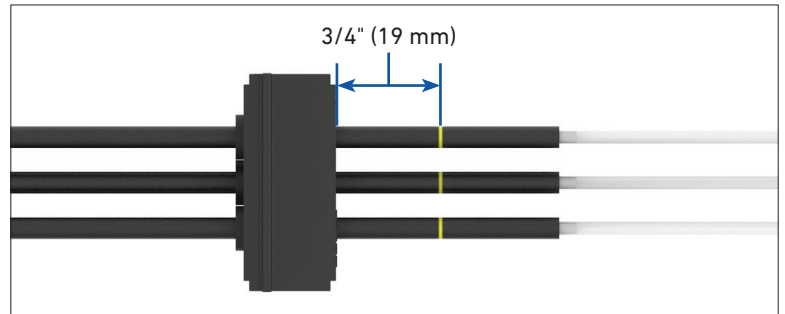

- 21 Position the retention clip even with the marks of the cables. Push down on the retention clip while stabilizing the cables to insert them into the slots of the retention clip. Keep pushing down on the retention clip until the cables are fully inserted into the slots.

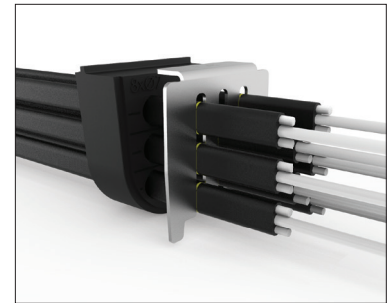
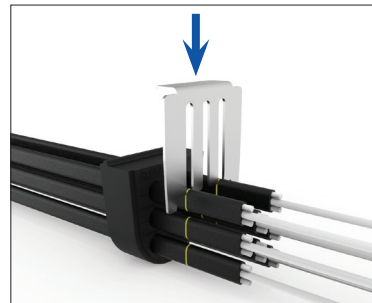

## INSTALLING GROMMETS AND SECURING CABLES

- 22 Lubricate the outer surface of the grommets with the silicone lubricant provided with the grommets. Spread the lubricant evenly around the outer surface of the grommet.

### CAUTION

Only use the silicone lubricant provided. Other lubricants can cause the grommet not to seal properly in the wall box.

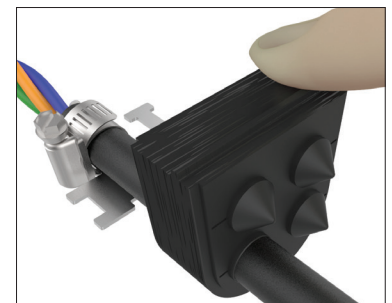
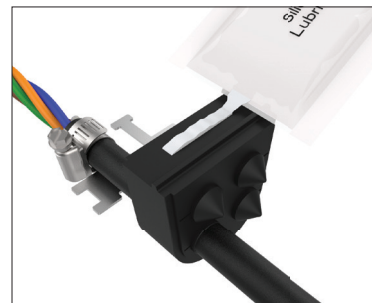

- 23 Insert the grommets with cables into the pockets of the cable entry ports while installing the cable restraint brackets onto the retention posts of the organizer or the cable retention clips into the slots of the retention posts of the organizer.

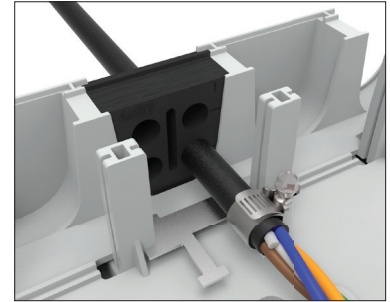
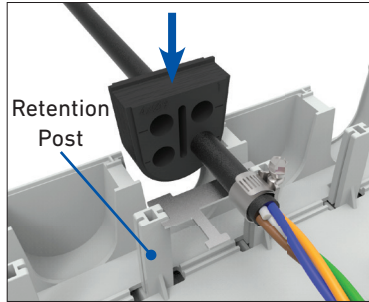

Grommet Installation with Cable Restraint Bracket

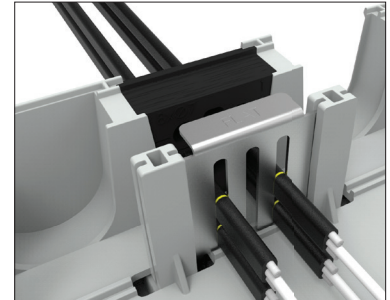
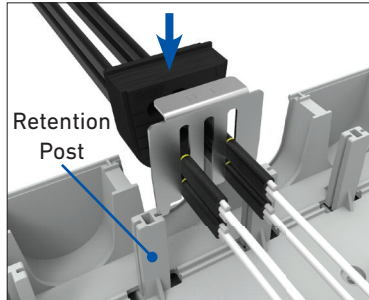

Grommet Installation with Cable Retention Clip

- 24 Trim the strength members of the cables flush with the ends of the retention cap platforms.

This can only be done at the inner three ports.

**NOTE:** Cable with strength member to be retained should be brought in through the bottom row of holes in the grommet. Cables brought in through higher up grommet holes may have difficulty bending the strength member down to the retention cap platform.

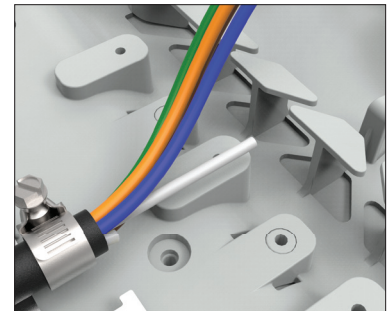
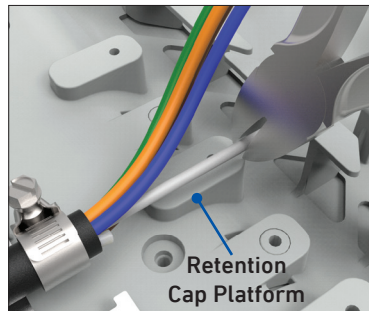

- 25 Insert the self-tapping screw into the retention cap. Capture the strength member(s) under the retention cap and secure the cap to the retention cap platform of the organizer. If the cable(s) contain aramid yarn, loosely install the cap to the platform. Wrap the braided aramid yarn(s) clockwise around the self-tapping screw under the cap and secure the cap to the platform.

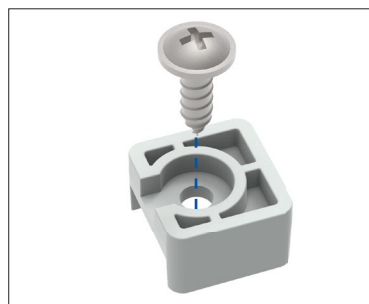

Installing Self-Tapping Screw in Cap

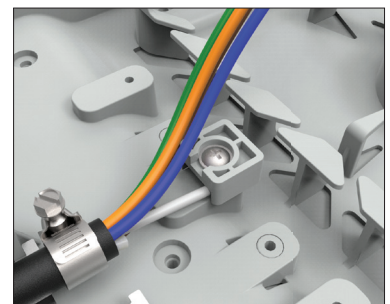

Securing Strength Member

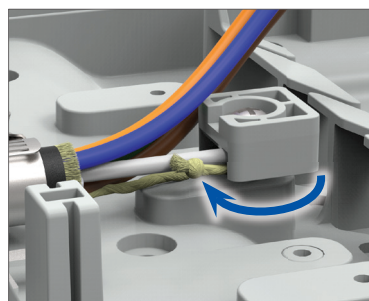

Wrapping Braided Aramid Yarn

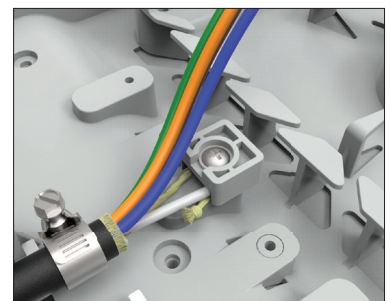

Securing Strength Member and Yarn

## INSTALLING SPLICE AND SPLITTER BLOCKS INTO SPLICE TRAY

FOR SPLICE ONLY APPLICATIONS

- 26** Install the splice block(s) and/or splitter block on the splice tray at the locations shown.

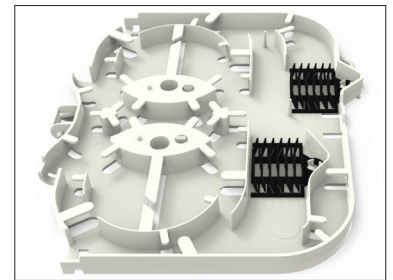
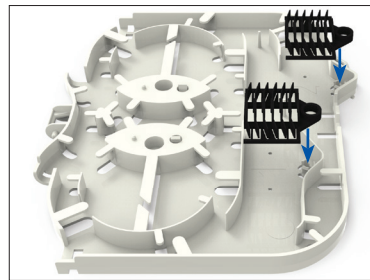

Installing Blocks into Splice Tray

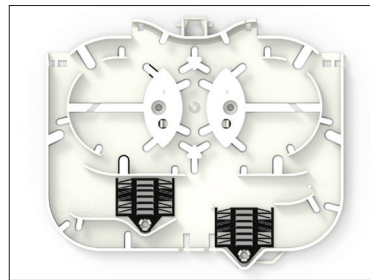

Two Splice Blocks Installed on Splice Tray

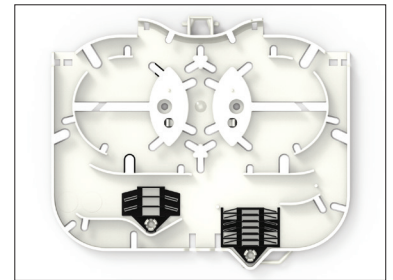

Splice Block and Splitter Block Installed on Splice Tray

## INSTALLING SPLICE TRAYS INTO SPLICE ONLY ORGANIZER

- 27** Push the splice trays into the hinge tabs of the splice tray modules of the organizer until the hinge pins of the splice tray are secured into the holes of the hinge tabs.

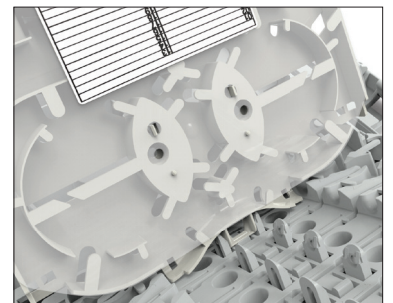
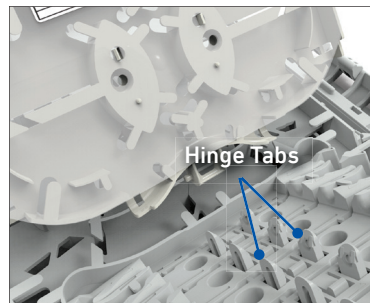

## ROUTING IN DIRECT SPLICE ORGANIZER

- 28** Release the splice tray manager from the retention tabs on the side of the organizer with a flat head screwdriver as shown.



Inserting Flat Head Screwdriver Under Hinge Post

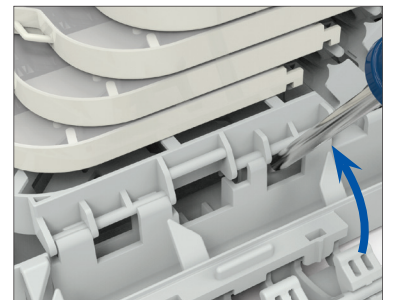

Rotating Flat Head Screwdriver Up to Release Hinge Post

- 29 Lift the splice tray manager to access the buffer tube routing area and route the buffer tubes or fibers to be expressed through the organizer as shown.

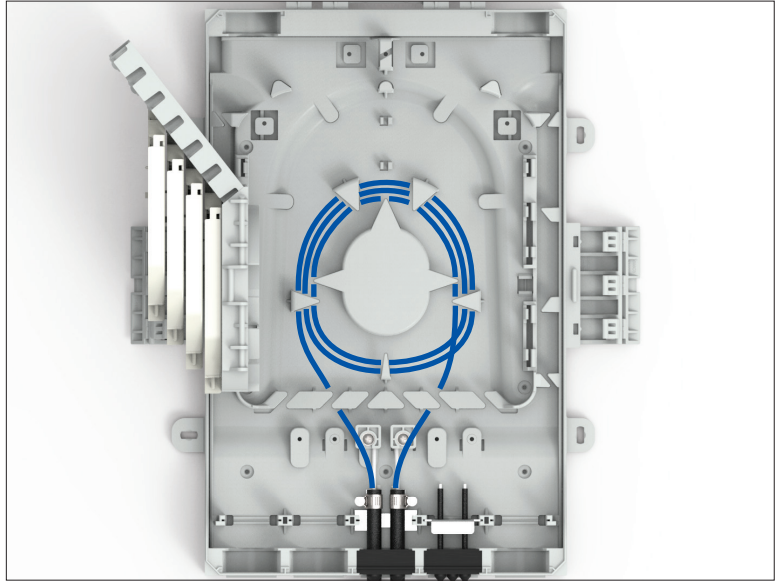

- 30 Route the incoming and outgoing buffer tubes in the organizer as shown.

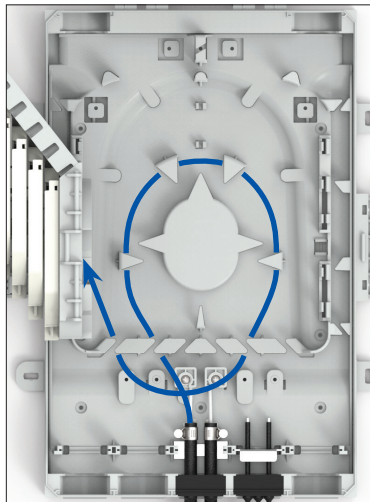

Incoming Buffer Tubes

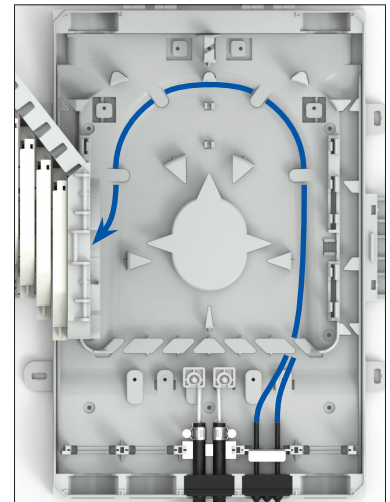

Outgoing Buffer Tubes

- 31 Route the incoming and outgoing buffer tubes in the bottom of the splice tray manager as shown.

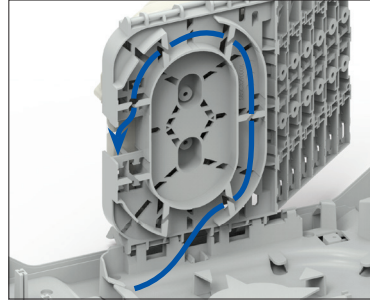

Incoming Buffer Tubes

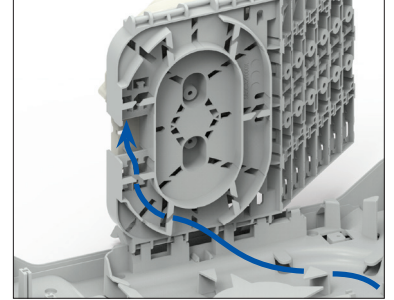

Outgoing Buffer Tubes

- 32 Lower the splice tray manager back into place and secure it in the retention tabs of the organizer. Wrap the ends of the incoming and outgoing buffer tubes with felt and secure them to the top of the splice tray manager with cable tie wraps as shown.

**NOTE:** LITE-GRIP® Retention Sleeves can be used in place of felt and cable tie wraps to secure the buffer tubes to the top of the splice tray manager but are not included.

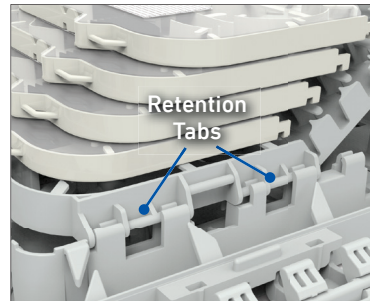
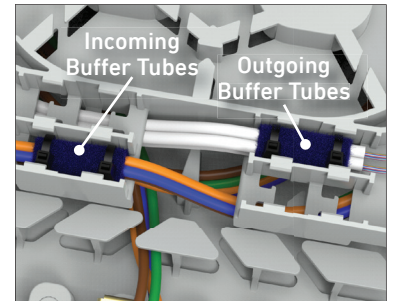
 Retention  
Tabs

 Incoming  
Buffer Tubes  
Outgoing  
Buffer Tubes

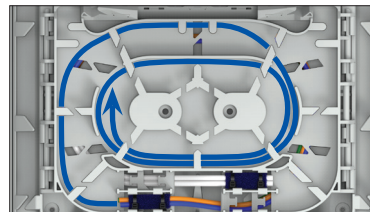
- 33 Route the dark fibers from the incoming and outgoing buffer tubes in the storage area located on the top of the splice tray manager.

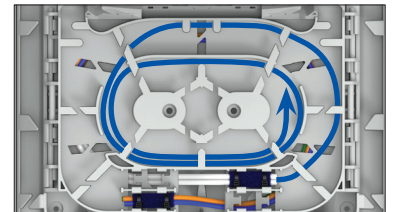

Incoming Dark Fibers



Outgoing Dark Fibers

- 34 Access the desired splice tray by rotating the top splice tray upwards until it locks in place. Continue to rotate and lock each splice tray below it in order until the desired splice tray is accessible.

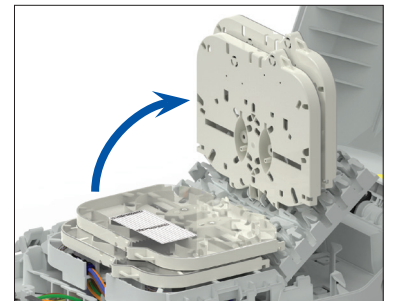
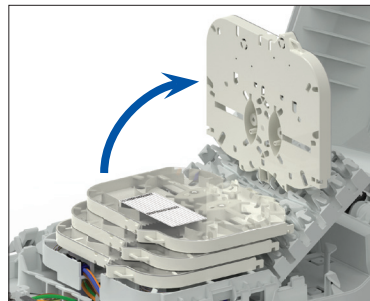

- 35 Route incoming and outgoing fibers in the side storage channels of the splice tray manager up to each splice tray.

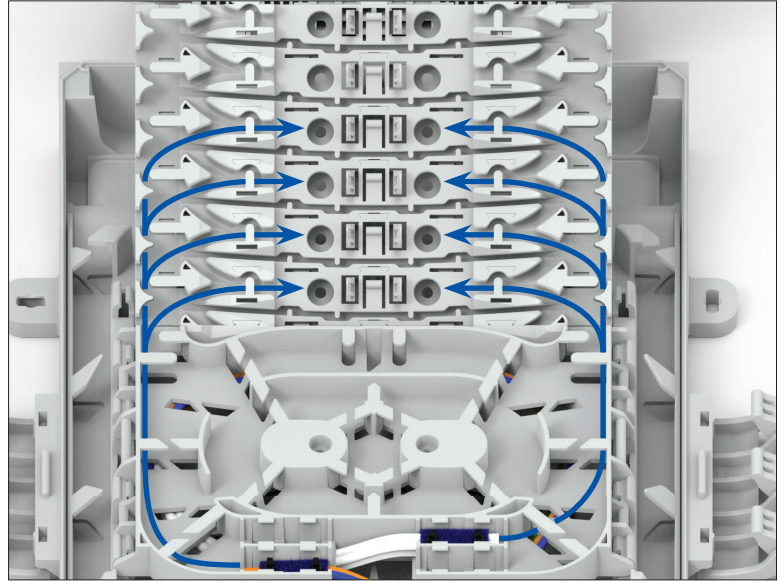

- 36 Route incoming and outgoing fibers in each splice tray as shown.

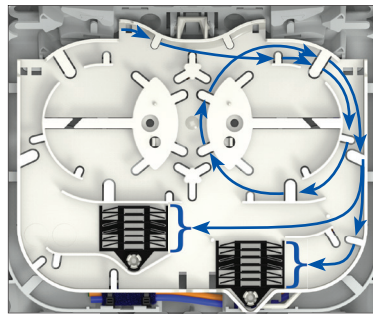

Routing for Incoming Fibers

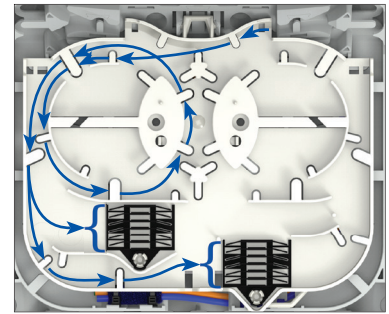

Routing for Outgoing Fibers

- 37 Splice the incoming fibers to the outgoing fibers per your accepted company practices and secure the splices in the splice block(s) of the splice tray.

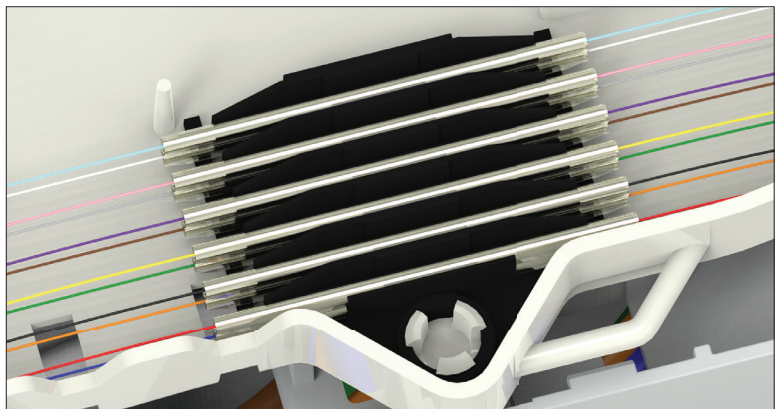

**38** Apply the labels to the covers of the cassettes.

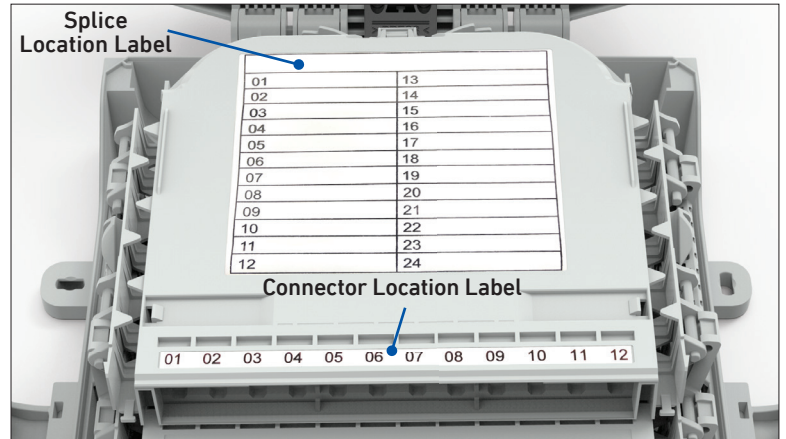

**39** Remove the covers from the cassettes by pushing out on the cover retention tabs while pushing up on the ends of the cover.

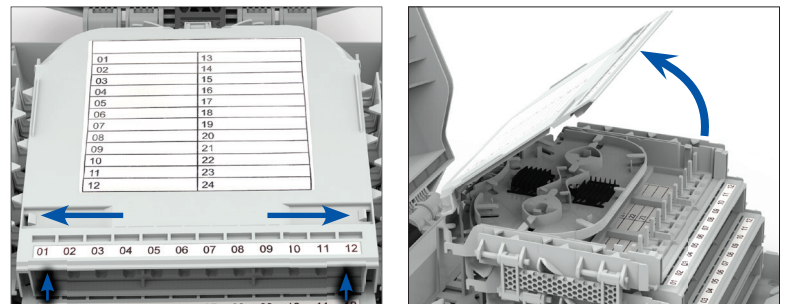

## INSTALLING SPLICE AND SPLITTER BLOCKS INTO CASSETTE FOR CROSS-CONNECT APPLICATIONS

**40** Install the splice block(s) and/or splitter block on the splice tray at the locations shown.

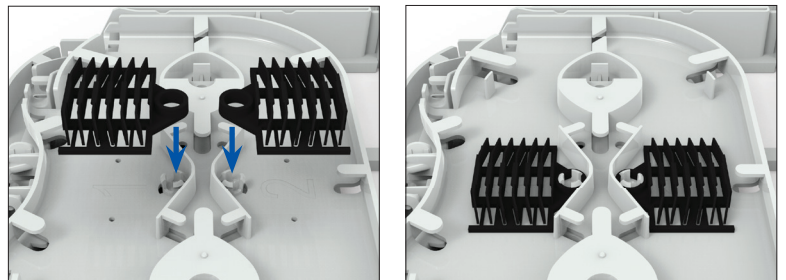

Installing Blocks into Splice Tray

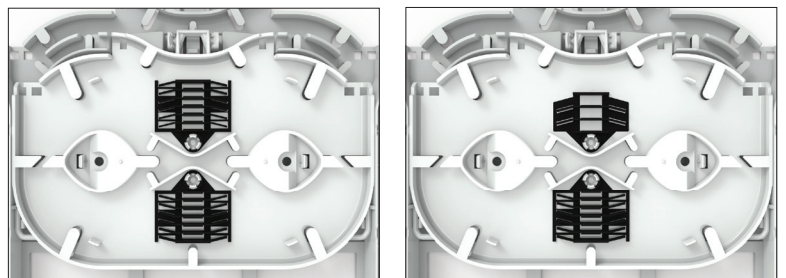

Two Splice Blocks Installed on Splice Tray

Splice Block and Splitter Block Installed on Splice Tray

## DISCONNECTING CASSETTES

- 41** Lift the cassette stack from the retention tabs on the right side of the organizer with a flat head screwdriver as shown.

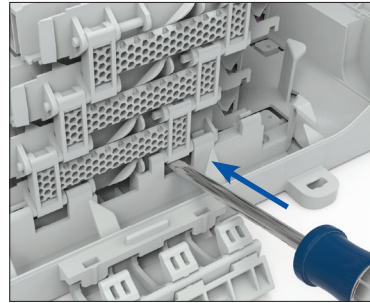

Inserting Flat Head Screwdriver Under Hinge Post

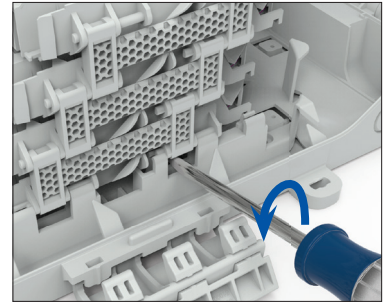

Rotating Flat Head Screwdriver 90 Degrees to Release Hinge Post

- 42** Disconnect the cassettes from one another with a flat head screwdriver as shown.

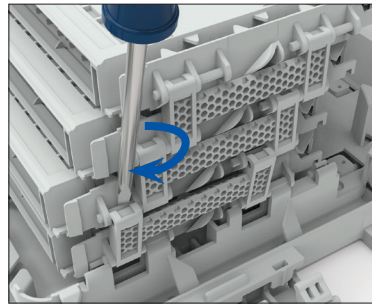

Inserting Flat Head Screwdriver Behind Connector

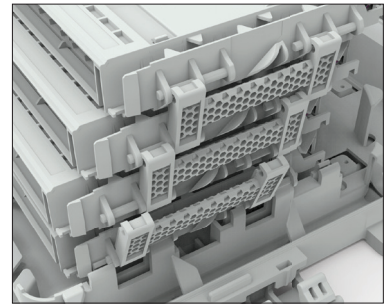

Rotating Flat Head Screwdriver to Release Connector

## ROUTING IN CROSS-CONNECT ORGANIZER

- 43** Rotate the cassettes upward to access the buffer tube routing area and route the buffer tubes or fibers to be expressed through the organizer as shown.

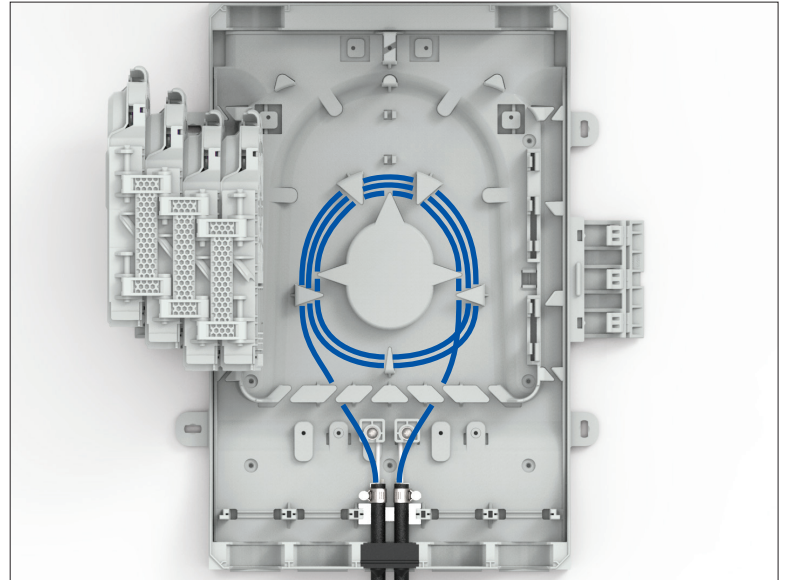

- 44** Route the incoming buffer tubes in the organizer as shown.

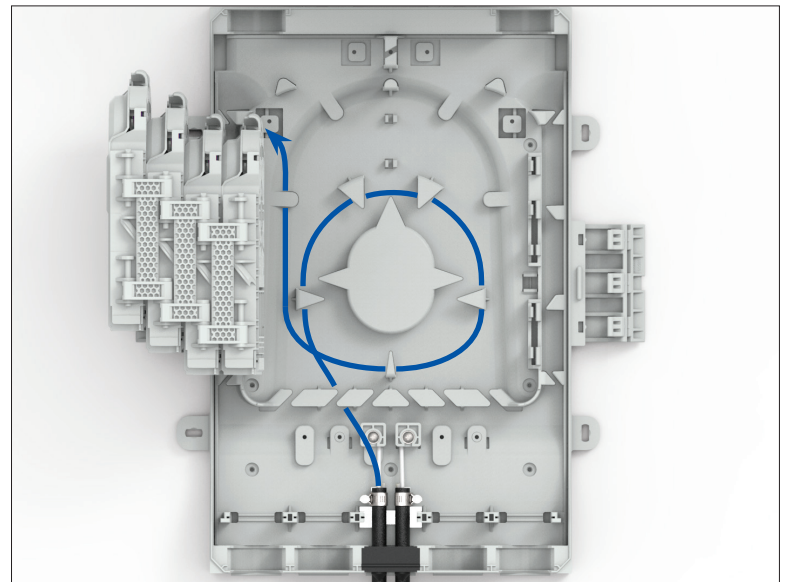

- 45** Wrap the end of each buffer tube with felt (not provided) and secure them to the cassettes with cable tie wraps.

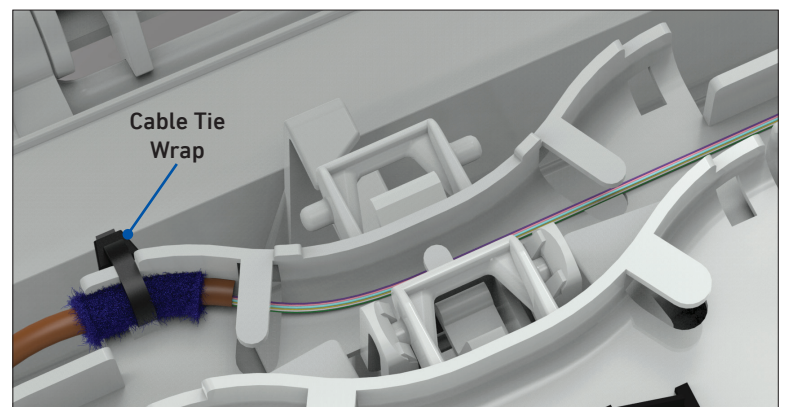

- 46 Route the incoming fibers in the cassettes as shown.

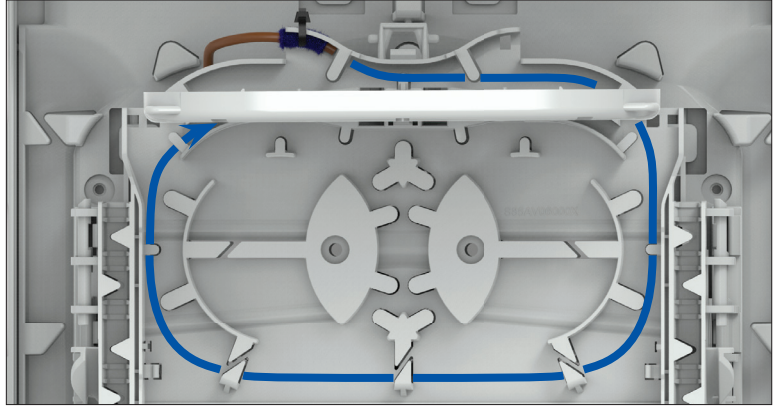

## INSTALLING ADAPTERS AND ROUTING INCOMING PIGTAILS IN CASSETTES

- 47 Insert the adapters into the adapter slots of the cassette from left to right as shown.

**NOTE:** Only simplex SC and duplex LC adapters with flanges can be used in the organizer.

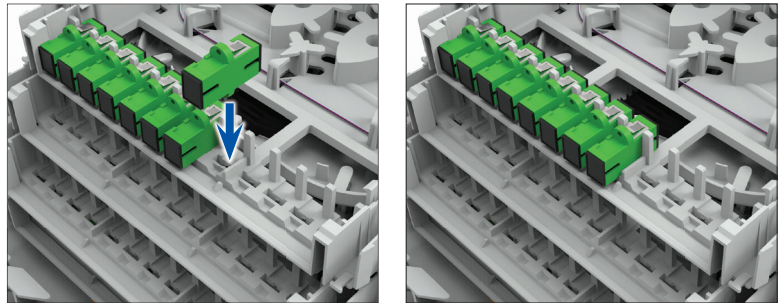

- 48 Remove the covers from the back of the adapters and insert the incoming pigtail connectors into the adapters.

**NOTE:** Follow your standard company practice for cleaning and installing connectors.

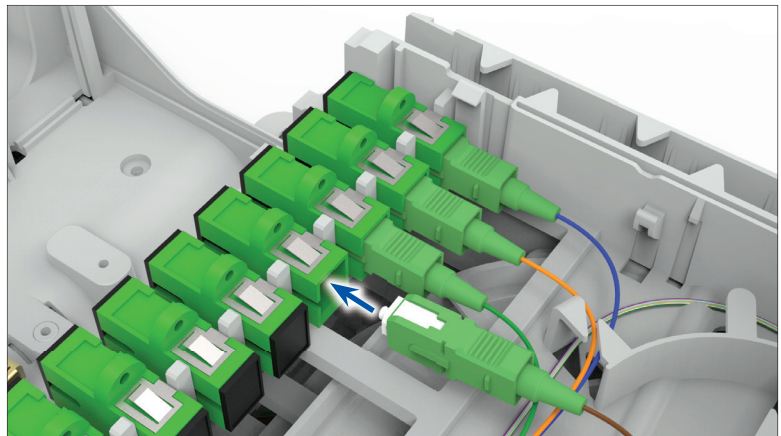

- 49 Route the pigtails in the cassette as shown.

**NOTE:** At least 52" (1.32 m) pigtail length is needed in order to fully route the pigtail from the adapter to the splice tray.

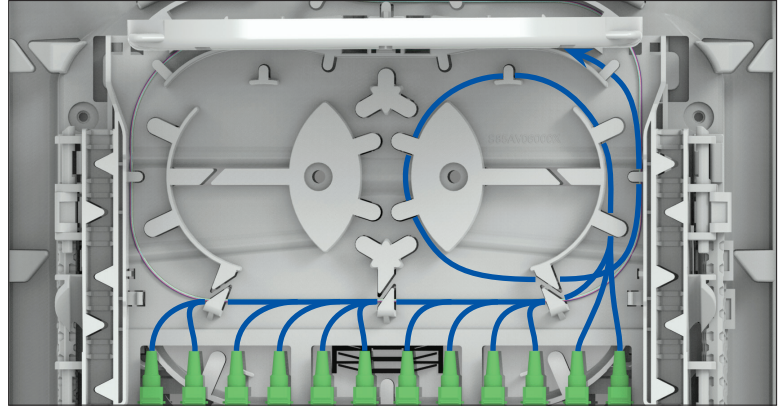

- 50 Wrap the pigtail bundle with felt (not provided) where the cable tie wrap slot is located on the splice tray and secure the bundle to the splice tray with a cable tie wrap.

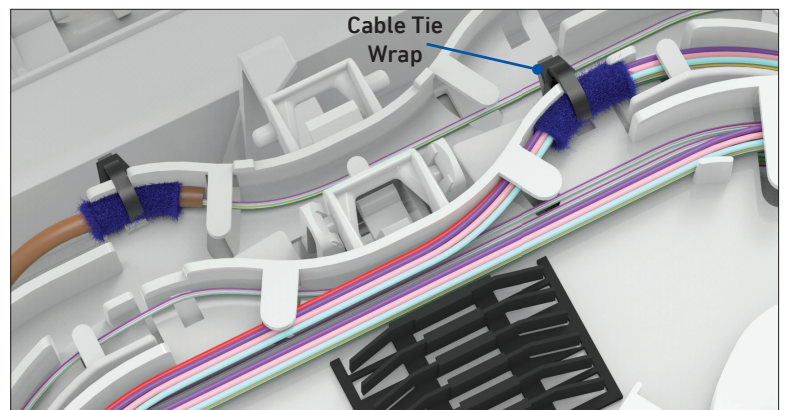

## SPLICE TRAY MANAGEMENT

- 51 Route the incoming fibers in each splice tray as shown.

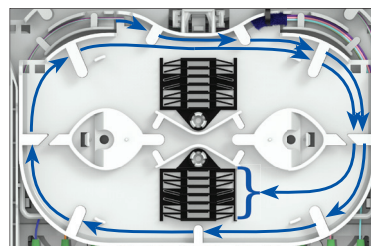

Routing for Incoming Fibers 1 – 12

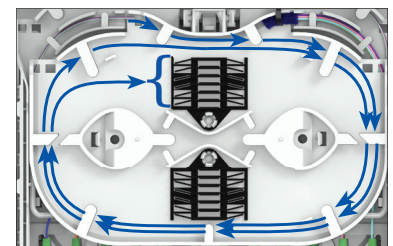

Routing for Incoming Fibers 13 – 24

- 52 Route the incoming pigtails in each splice tray as shown.

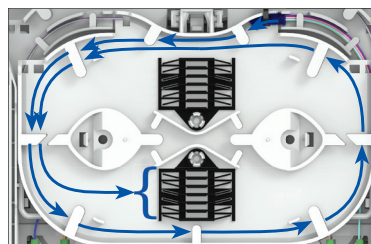

Routing for Incoming Pigtails 1 – 12

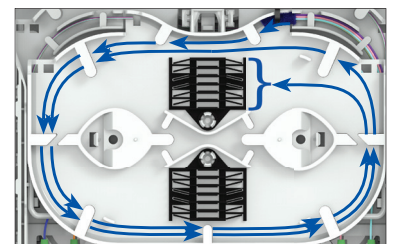

Routing for Incoming Pigtails 13 – 24

- 53 For splitter applications, route the incoming and outgoing fibers of the splitter in each splice tray as shown.

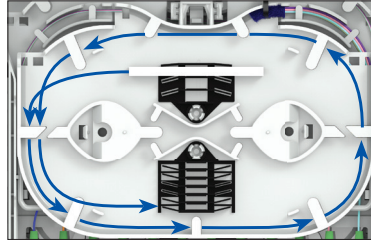

Routing for Incoming Fibers

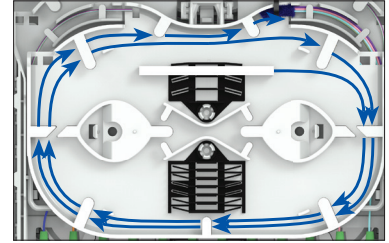

Routing for Outgoing Fibers

- 54 Splice the incoming fibers to the outgoing fibers per your accepted company practices and secure the splices in the splice block(s) of the splice tray.

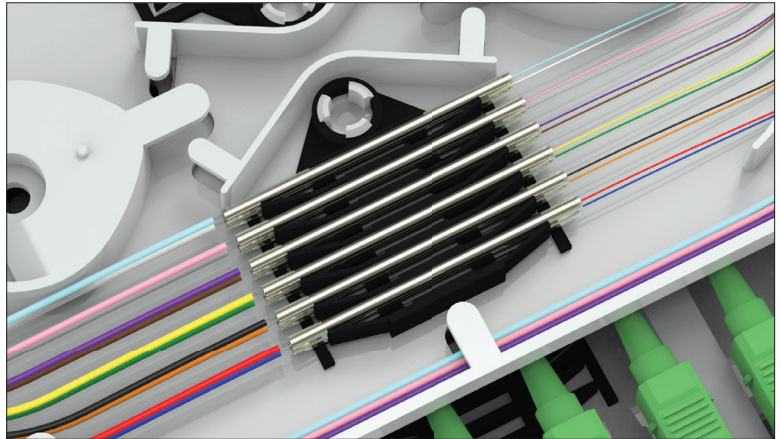

- 55 Install the cassette cover on the hinge tab of the cassette and rotate the cover down. Press down on the cover to ensure the retention tabs of the cassette are engaged and the cover is secured.

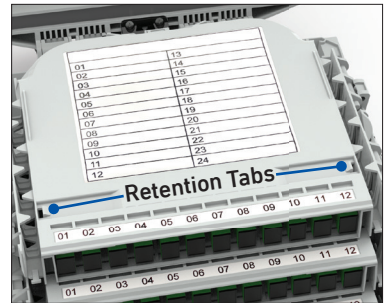
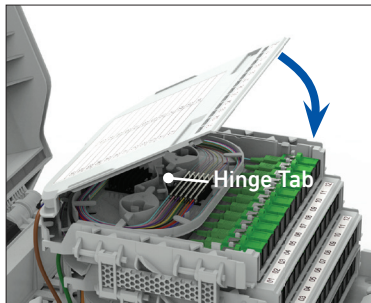

## ROUTING AND SECURING OUTGOING CABLES FOR CROSS-CONNECT APPLICATIONS

- 56** Remove the covers from the front of the adapters of the cassettes and insert the connectors of the outgoing connectorized drop cables or jumper cables into the adapters.

**NOTE:** At least 40" (1.02 m) jumper length is needed in order to fully route the jumper from the entry grommet to the cassette.

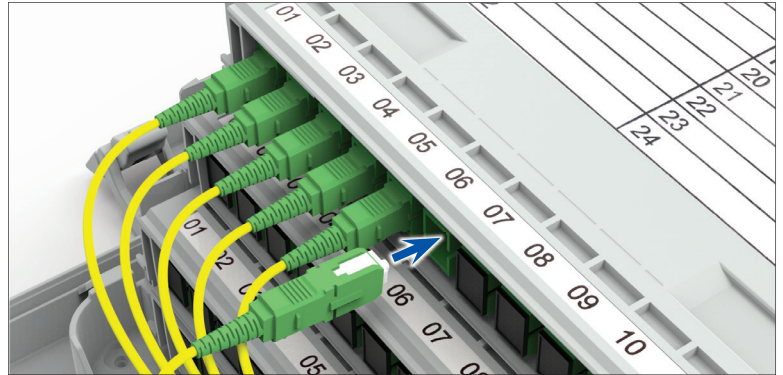

- 57** Route the outgoing connectorized drop cables or jumper cables in the side channels of the cassettes and organizer as shown.

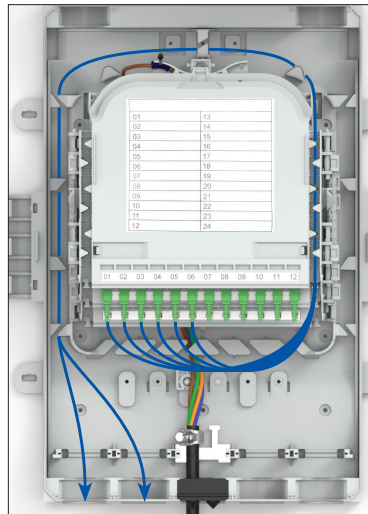

Routing for Outgoing  
Connectorized Cables 1 – 6

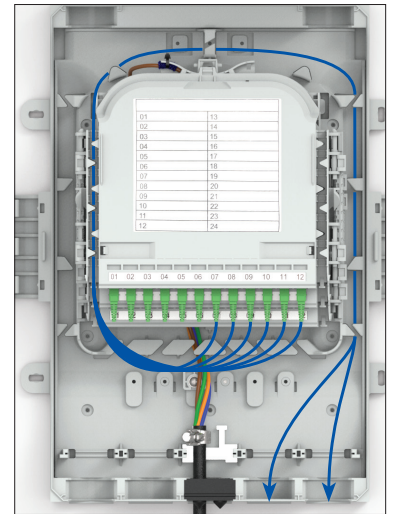

Routing for Outgoing  
Connectorized Cables 7 – 12

- 58** Secure the outgoing connectorized drop cable or jumper cable bundles to the cassettes with cable tie wraps as shown.

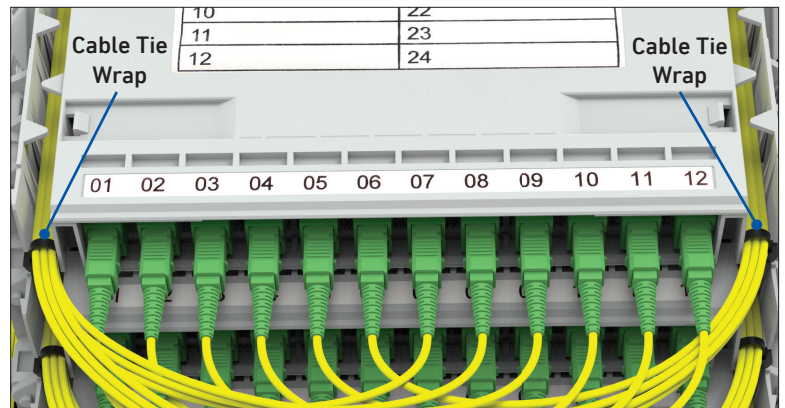

- 59 Reconnect the cassettes to one another by pushing against the top of each connector until it secures to the hinge pins of the upper cassette.

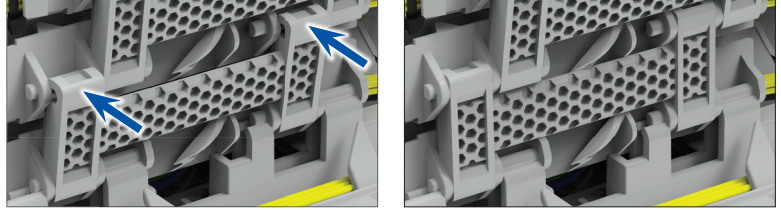

- 60 Secure the cassette stack to the organizer by pushing down on the stack until the hinge pins of the bottom cassette are secured within the retention tabs of the organizer.

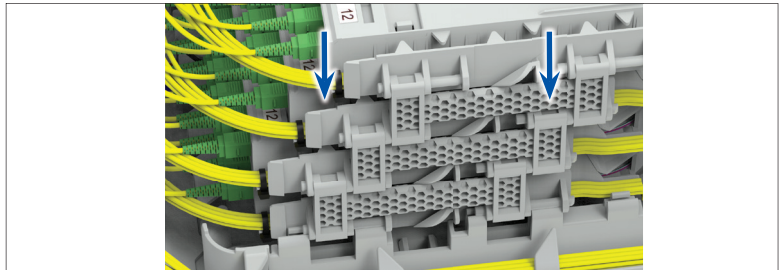

- 61 Apply silicone lubricant to the outer surface of the bottom section of each 24-Hole grommet and insert them into the pockets of the outer cable entry ports. Install a cable restraint bracket onto the retention posts of the organizer as shown for each outer cable port.

**NOTE:** Do not apply silicone lubricant to the slotted surface of the grommet section.

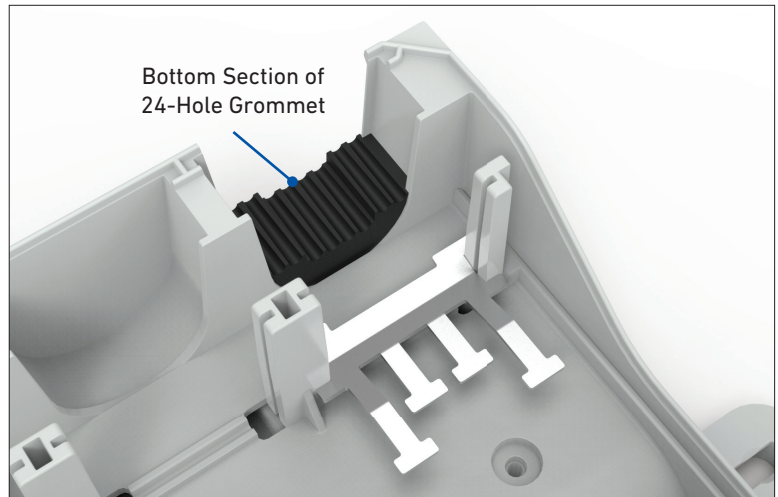

- 62 Route the outgoing cables to the outer cable ports and insert the cables and/or plugs into the slots of the installed grommet section in an organized manner. Secure the cables to the cable restraint brackets with cable tie wraps.

**NOTE:** Two cables should be secured to each leg of the cable restraint bracket.

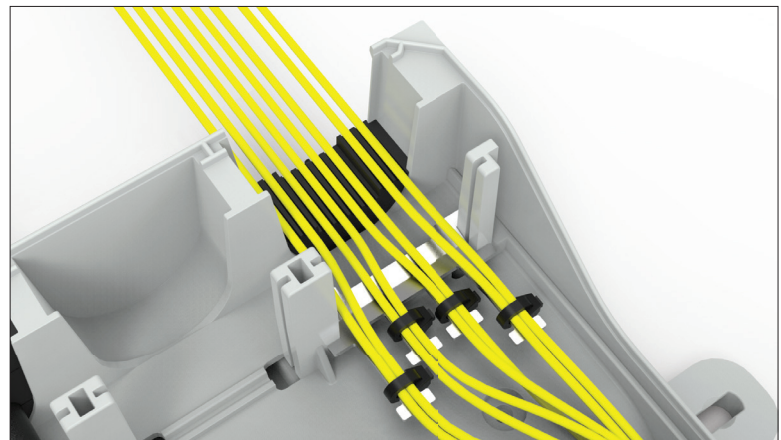

- 63** Repeat the process described in Steps 62 and 63 for each grommet section until the grommets have been completely assembled and all the outgoing cables have been secured.

**NOTE:** Refer to Step 11 for guide on how to assemble the 24-hole grommet with plugs if the grommet is not being fully populated with cables.

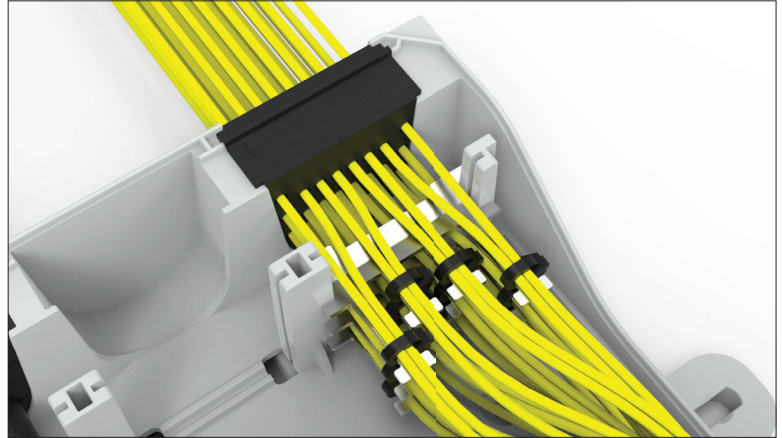

## SECURING COVER

- 64** To close the cover, push on the center of the cover kickstand while rotating the cover downwards.

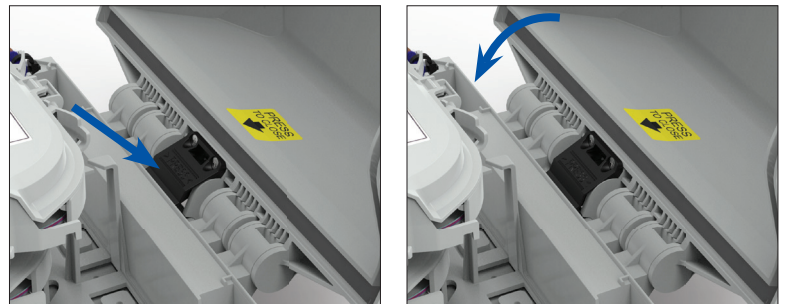

- 65** Hinge the cover closed and engage the bottom latch under the base as shown. Push the flap portion of the latch towards the base to secure the latch.

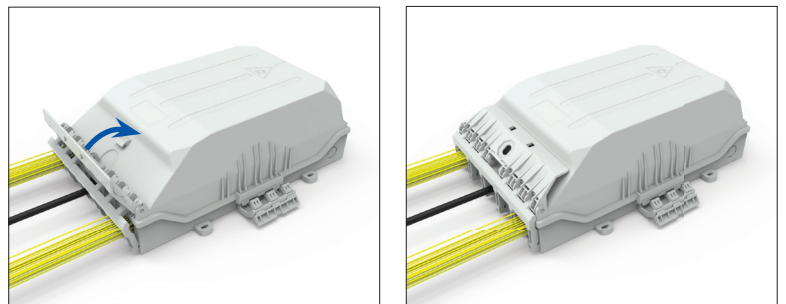

- 66** Raise the side latches of the base and rest the retention tabs of the latches into the retention pockets of the cover as shown. Push the flaps of the side latches towards the cover until they snap into place to fully secure the cover to the base.

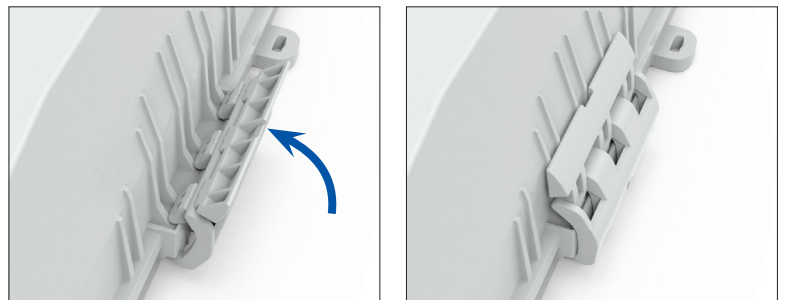











## APPENDIX A

### COYOTE DEN5 Wall Box Kits

Catalog Number	Description
COYDEN5-SPL	COYOTE DEN5 Wall Box with Direct Splice Organizer – Includes (4) COYOTE DEN 24 CT. Deep Profile Flip Splice Tray Kits, (1) 4-Hole Grommet Kit: (2 Holes) 0.38" – 0.46" (9.6 – 11.7 mm) & (2 Holes) 0.46" – 0.51" (11.7 – 13.0 mm), (1) 4-Hole Grommet Kit: (4 Holes) 0.30" – 0.38" (7.6 – 9.6 mm), (2) 24-Hole Grommet Kits: (24 Holes) 0.07" – 0.12" (1.8 – 3.0 mm), & (1) Small Parts Bag
COYDEN5-CSTE2	COYOTE DEN5 Wall Box with 2 Cassette Trays – Includes (2) Cassette Splice Location Labels, (2) Cassette Connector Location Labels, (1) 4-Hole Grommet Kit: (2 Holes) 0.38" – 0.46" (9.6 – 11.7 mm) & (2 Holes) 0.46" – 0.51" (11.7 – 13.0 mm), (1) 4-Hole Grommet Kit: (4 Holes) 0.30" – 0.38" (7.6 – 9.6 mm), (2) 24-Hole Grommet Kits: (24 Holes) 0.07" – 0.12" (1.8 – 3.0 mm), & (1) Small Parts Bag
COYDEN5-CSTE4	COYOTE DEN5 Wall Box with 4 Cassette Trays – Includes (4) Cassette Splice Location Labels, (4) Cassette Connector Location Labels, (1) 4-Hole Grommet Kit: (2 Holes) 0.38" – 0.46" (9.6 – 11.7 mm) & (2 Holes) 0.46" – 0.51" (11.7 – 13.0 mm), (1) 4-Hole Grommet Kit: (4 Holes) 0.30" – 0.38" (7.6 – 9.6 mm), (2) 24-Hole Grommet Kits: (24 Holes) 0.07" – 0.12" (1.8 – 3.0 mm), & (1) Small Parts Bag

## APPENDIX B

### Grommet Kits for COYOTE® DEN Wall Boxes

Catalog Number	Cable Range	Description	Image	Slitting Location
	in (mm)			
80814377	0.07" – 0.12" (1.8 mm – 3.0 mm)	24-Hole Grommet		
80814378	0.14" – 0.22" (3.6 mm – 5.6 mm)	12-Hole Grommet		
80814379	0.22" – 0.30" (5.6 mm – 7.6 mm) or Flat Drop	8-Hole Grommet		
80814380	0.30" – 0.38" (7.6 mm – 9.6 mm)	4-Hole Grommet		
80814381	0.38" – 0.46" (9.6 mm – 11.7 mm) & 0.46" – 0.51" (11.7 mm – 13.0 mm)	4-Hole Grommet		

## APPENDIX C

### Splice Tray and Splice Tray Accessory Kits for COYOTE® DEN5 Wall Boxes

PLP Catalog Number	Description
80814325	Cross-Connect 24 CT. Single Fusion Cassette for COYOTE DEN5 Cross-Connect Wall Box
80808187	Heat Shrink Splice Protector Kit – Includes (12) 40 mm Single Fusion
8004095	Heat Shrink Splice Protector Kit – Includes (50) 40 mm Single Fusion
8003509	Heat Shrink Splice Protector Kit – Includes (12) 60 mm Single Fusion
8003717	Heat Shrink Splice Protector Kit – Includes (50) 60 mm Single Fusion
8003490	Felt Tape Kit – Includes (6) 9" Long Buffer Tube Felt Strips

## APPENDIX D

### COYOTE® Cross-Connect Accessory Kits

Catalog Number	Description
80813593	Adapter Kit – Includes (8) SC/APC Simplex Adapters
80813594	Adapter Kit – Includes (8) SC/UPC Simplex Adapters
80813597	Adapter Kit – Includes (8) LC/APC Duplex Adapters
80813598	Adapter Kit – Includes (8) LC/UPC Duplex Adapters
800013979	Fiber Pigtail Kit – Includes (2) 1.5 m SC/APC 900 µm Color-Coded Pigtails
800014109	Fiber Pigtail Kit – Includes (2) 1.5 m SC/UPC 900 µm Color-Coded Pigtails
800013980	Fiber Pigtail Kit – Includes (3) 1.5 m SC/APC 900 µm Color-Coded Pigtails
800014110	Fiber Pigtail Kit – Includes (3) 1.5 m SC/UPC 900 µm Color-Coded Pigtails
800015055	Fiber Pigtail Kit – Includes (4) 1.5 m SC/APC 900 µm Color-Coded Pigtails
80812558	Fiber Pigtail Kit – Includes (4) 1.5 m SC/UPC 900 µm Color-Coded Pigtails
80812983	Fiber Pigtail Kit – Includes (2) 1.5 m LC/APC 900 µm Color-Coded Pigtails
80812985	Fiber Pigtail Kit – Includes (2) 1.5 m LC/UPC 900 µm Color-Coded Pigtails
80812559	Fiber Pigtail Kit – Includes (4) 1.5 m LC/APC 900 µm Color-Coded Pigtails
80812560	Fiber Pigtail Kit – Includes (4) 1.5 m LC/UPC 900 µm Color-Coded Pigtails
COYSP1X2 <sup>1</sup>	COYOTE Bare Fiber Splitter – 1x2
COYSP1X4 <sup>1</sup>	COYOTE Bare Fiber Splitter – 1x4
COYSP1X8 <sup>1</sup>	COYOTE Bare Fiber Splitter – 1x8
COYSP1X2SCA	COYOTE Pre-Connectorized Splitter – 1x2 SC/APC
COYSP1X4SCA	COYOTE Pre-Connectorized Splitter – 1x4 SC/APC
COYSP1X8SCA	COYOTE Pre-Connectorized Splitter – 1x8 SC/APC

<sup>1</sup> Add Suffix: -S for 250µm Output Legs



---

**GLOBAL HEADQUARTERS**  
660 BETA DRIVE  
CLEVELAND, OH 44143

+1 440 461 5200  
INFO@PLP.COM  
PLP.COM