

## COYOTE® GLC

### 9.5" X 17" AND 9.5" X 28"

The **COYOTE GLC (Ground Level Closure)** offers two length options of 17" and 28" to support either buffer tube or ribbon fiber applications. These closures utilize PLP's patented segmented end plate design, which allows for easy installation of a variety of cable sizes in conjunction with our grommets. The GLC is a hermetically sealed pedestal system that permits a high volume of uncut slack storage and its unique design doesn't force you to work where the closure is installed.

### FEATURES AND BENEFITS

- 4-Port segmented end plate design provides independent access to each cable port without disrupting surrounding cables
- Multiple tray designs support mass fusion splicing, single fusion splicing, or a combination of both
- Flexible grommet sealing technology supports a wide range of flat and round cable profiles
- Hermetically sealed dome eliminates potential for water intrusion and prevents invasion of insects
- Accessible isolated grounding system that allows ground testing to occur without entering the splice closure
- Slack storage of uncut cable allows dome closure to be carried to a splice truck or other suitable working environment
- The small GLC base with cover can be used for pedestrian applications (Tier 5)

## SPECIFICATIONS

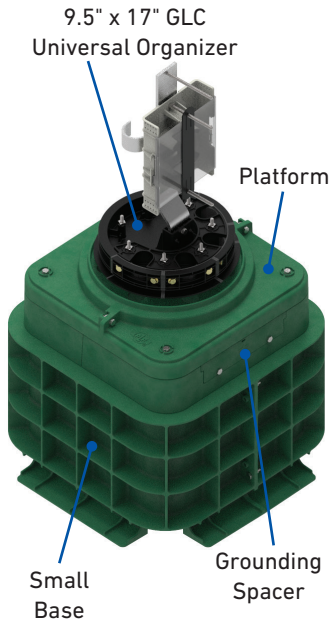

### COYOTE 9.5" x 17" GLC with Universal Organizer

<b>Catalog Numbers</b>		<b>COYGLC-F1-000, COYGLC-F1B-000, COYGLC-F1B-100</b>
Splice Capacity (Maximum) – Single Fusion (Low Profile, 80809958), Single Fusion (Low Profile, 80813152), Single Fusion (Deep Profile, 80808945), Mass Fusion (Deep Profile, LGSTR144)		96, 144, 80, 288
Number of Splice Trays – 80809958, 80813152, 80808945, LGSTR144		4, 4, 2, 2
Cable Ports <sup>1</sup>		4
Cable Diameters	Small Base	0.093" – 0.60" (2.4 – 15.2 mm) and Flat Drop
	Large Base	0.093" – 1.25" (2.4 – 31.8 mm) and Flat Drop
Ground Studs		4
Configuration		Butt
Cable Types		Buffer Tube or Ribbon
Application		Pedestal
Ingress Protection		In accordance with Telcordia® GR-771-CORE, Pedestal; IP-68
Size <sup>2</sup>		15.4" L x 15.4" W x 20.4" H (390 x 390 x 520 mm)
Kit Contents <sup>3</sup>	COYGLC-F1-000	Includes (1) Standard Platform
	COYGLC-F1B-000	Includes (1) Standard Platform and (1) Small Base
	COYGLC-F1B-100	Includes (1) Standard Platform, (1) Small Base, & (1) Grounding Spacer Kit

<sup>1</sup> Multi-hole grommets allow for more than one cable to enter each cable port

<sup>2</sup> Includes platform, collar, and dome assembly only. See COYOTE GLC Bases for base sizes

<sup>3</sup> All kits include (1) Green GLC Dome, (1) COYOTE 9.5" End Plate with Organizer, (1) Gasket, (1) Collar, (2) 2-Hole Grommets, (1) 4-Hole Grommet, (1) 6-Hole Grommet, (1) Splice Tray (Catalog Number: 80808945) and Cable Restraint Hardware.

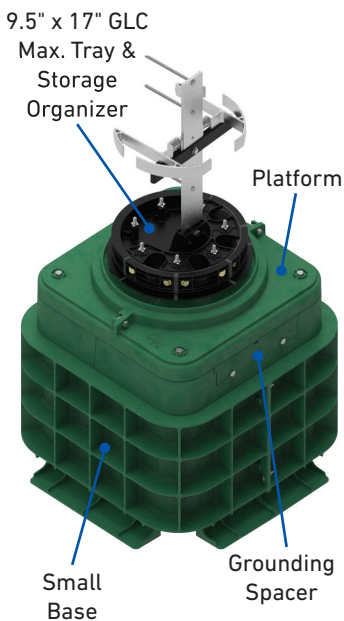

### COYOTE 9.5" x 17" GLC with Maximum Tray & Storage Organizer

<b>Catalog Numbers</b>		<b>COYGLC-F2-000, COYGLC-F2B-000, COYGLC-F2B-100</b>
Splice Capacity (Maximum) – Single Fusion (Low Profile, 80809958), Single Fusion (Low Profile, 80813152), Single Fusion (Deep Profile, 80808945), Mass Fusion (Deep Profile, LGSTR144)		312, 468, 240, N/A
Number of Splice Trays – 80809958, 80813152, 80808945, LGSTR144		13, 13, 6, N/A
Cable Ports <sup>1</sup>		4
Cable Diameters	Small Base	0.093" – 0.60" (2.4 – 15.2 mm) and Flat Drop
	Large Base	0.093" – 1.25" (2.4 – 31.8 mm) and Flat Drop
Ground Studs		4
Configuration		Butt
Cable Types		Buffer Tube Only
Application		Pedestal
Ingress Protection		In accordance with Telcordia® GR-771-CORE, Pedestal; IP-68
Size <sup>2</sup>		15.4" L x 15.4" W x 20.4" H (390 x 390 x 520 mm)
Kit Contents <sup>3</sup>	COYGLC-F2-000	Includes (1) Standard Platform
	COYGLC-F2B-000	Includes (1) Standard Platform and (1) Small Base
	COYGLC-F2B-100	Includes (1) Standard Platform, (1) Small Base, & (1) Grounding Spacer Kit

<sup>1</sup> Multi-hole grommets allow for more than one cable to enter each cable port

<sup>2</sup> Includes platform, collar, and dome assembly only. See COYOTE GLC Bases for base sizes

<sup>3</sup> All kits include (1) Green GLC Dome, (1) COYOTE 9.5" End Plate with Organizer, (1) Gasket, (1) Collar, (2) 2-Hole Grommets, (1) 4-Hole Grommet, (1) 6-Hole Grommet, (1) Splice Tray (Catalog Number: 80808945) and Cable Restraint Hardware.

# SPECIFICATIONS

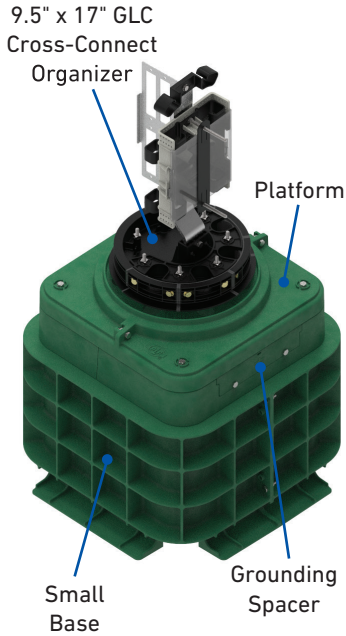

## COYOTE 9.5" x 17" GLC with Cross-Connect Organizer

<b>Catalog Number</b>		<b>COYGLC-F3-000, COYGLC-F3B-000, COYGLC-F3B-100</b>
Splice Capacity (Maximum) – Single Fusion (Low Profile, 80809958), Single Fusion (Low Profile, 80813152), Single Fusion (Deep Profile, 80808945), Mass Fusion (Deep Profile, LGSTR144)		96, 144, 80, 288
Number of Splice Trays – 80809958, 80813152, 80808945, LGSTR144		4, 4, 2, 2
Cable Ports <sup>1</sup>		4
Cable Diameters	Small Base	0.093" – 0.60" (2.4 – 15.2 mm) and Flat Drop
	Large Base	0.093" – 1.25" (2.4 – 31.8 mm) and Flat Drop
Ground Studs		4
Configuration		Butt
Cable Types		Buffer Tube or Ribbon
Application		Pedestal
Ingress Protection		In accordance with Telcordia® GR-771-CORE, Pedestal; IP-68
Size <sup>2</sup>		15.4" L x 15.4" W x 20.4" H (390 x 390 x 520 mm)
Adapter Port Quantity (Maximum)		48 SC or 96 LC
Kit Contents <sup>3</sup>	COYGLC-F3-000	Includes (1) Standard Platform
	COYGLC-F3B-000	Includes (1) Standard Platform and (1) Small Base
	COYGLC-F3B-100	Includes (1) Standard Platform, (1) Small Base, & (1) Grounding Spacer Kit

<sup>1</sup> Multi-hole grommets allow for more than one cable to enter each cable port

<sup>2</sup> Includes platform, collar, and dome assembly only. See COYOTE GLC Bases for base sizes

<sup>3</sup> All kits include (1) Green GLC Dome, (1) COYOTE 9.5" End Plate with Organizer, (1) Gasket, (1) Collar, (2) 2-Hole Grommets, (1) 4-Hole Grommet, (1) 6-Hole Grommet, (1) Splice Tray (**Catalog Number: 80808945**) and Cable Restraint Hardware. Additional selections of adapter and pigtail accessories are required.

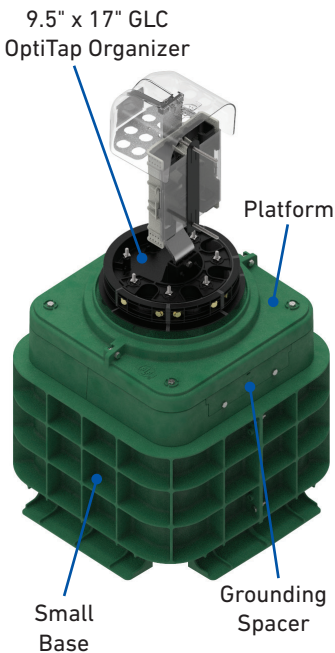

## COYOTE 9.5" x 17" GLC with OptiTap® Organizer

<b>Catalog Number</b>		<b>COYGLC-F4-000, COYGLC-F4B-000, COYGLC-F4B-100</b>
Splice Capacity (Maximum) – Single Fusion (Low Profile, 80809958), Single Fusion (Low Profile, 80813152), Single Fusion (Deep Profile, 80808945), Mass Fusion (Deep Profile, LGSTR144)		96, 144, 80, 288
Number of Splice Trays – 80809958, 80813152, 80808945, LGSTR144		4, 4, 2, 2
Cable Ports <sup>1</sup>		4
Cable Diameters	Small Base	0.093" – 0.60" (2.4 – 15.2 mm) and Flat Drop
	Large Base	0.093" – 1.25" (2.4 – 31.8 mm) and Flat Drop
Ground Studs		4
Configuration		Butt
Cable Types		Buffer Tube or Ribbon and Pre-Connectorized Hardened Drop
Application		Pedestal
Ingress Protection		In accordance with Telcordia® GR-771-CORE, Pedestal; IP-68
Size <sup>2</sup>		15.4" L x 15.4" W x 20.4" H (390 x 390 x 520 mm)
Kit Contents <sup>3</sup>	COYGLC-F4-000	Includes (1) Standard Platform
	COYGLC-F4B-000	Includes (1) Standard Platform and (1) Small Base
	COYGLC-F4B-100	Includes (1) Standard Platform, (1) Small Base, & (1) Grounding Spacer Kit

<sup>1</sup> Multi-hole grommets allow for more than one cable to enter each cable port

<sup>2</sup> Includes platform, collar, and dome assembly only. See COYOTE GLC Bases for base sizes

<sup>3</sup> All kits include (1) Green GLC Dome, (1) COYOTE 9.5" End Plate with Organizer, (1) Gasket, (1) Collar, (2) 2-Hole Grommets, (1) 4-Hole Grommet, (1) 6-Hole Grommet, (1) Splice Tray (**Catalog Number: 80808945**) and Cable Restraint Hardware. Additional selection of OptiTap® adapters are required.

## SPECIFICATIONS

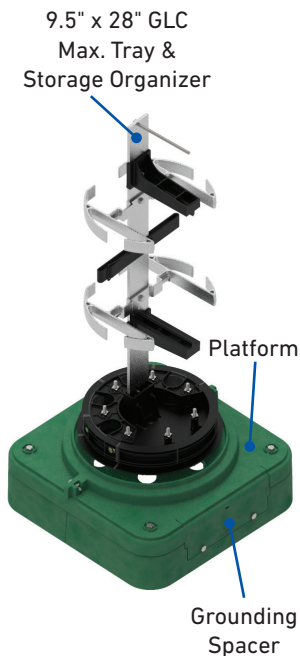
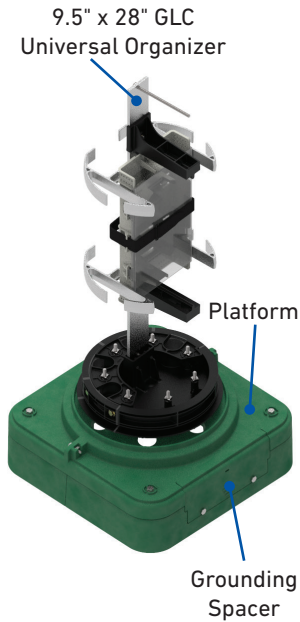

### COYOTE 9.5" x 28" GLC with Universal Organizer

Catalog Number		COYGLC-F5-000, COYGLC-F5-100
Splice Capacity (Maximum) – Single Fusion (Standard Profile, 80810086), Single Fusion (Deep Profile, LGSTS72), Mass Fusion (Deep Profile, LGSTR216)		180, 288, 864
Number of Splice Trays – 80810086, LGSTS72, LGSTR216		5, 4, 4
Cable Ports <sup>1</sup>		4
Cable Diameters	Small Base	0.093" – 0.60" (2.4 – 15.2 mm) and Flat Drop
	Large Base	0.093" – 1.25" (2.4 – 31.8 mm) and Flat Drop
Ground Studs		4
Configuration		Butt
Cable Types		Buffer Tube or Ribbon
Application		Pedestal
Ingress Protection		In accordance with Telcordia® GR-771-CORE, Pedestal; IP-68
Size <sup>2</sup>		15.4" L x 15.4" W x 31.6" H (390 x 390 x 800 mm)
Kit	COYGLC-F5-000	Includes (1) Standard Platform
Contents <sup>3</sup>	COYGLC-F5-100	Includes (1) Platform with Cutout and (1) Grounding Spacer Kit

<sup>1</sup> Multi-hole grommets allow for more than one cable to enter each cable port

<sup>2</sup> Includes platform, collar, and dome assembly only. See COYOTE GLC Bases for base sizes

<sup>3</sup> All kits include (1) Green GLC Dome, (1) COYOTE 9.5" End Plate with Organizer, (1) Gasket, (1) Collar, (2) 1-Hole Grommets 0.60" – 0.85" (15.2 – 21.6 mm), (1) 2-Hole Grommet, (1) 7-Hole Grommet, (1) Splice Tray (Catalog Number: LGSTS72) and Cable Restraint Hardware.

### COYOTE 9.5" x 28" GLC with Max. Tray & Storage Organizer

Catalog Number		COYGLC-F6-000, COYGLC-F6-100
Splice Capacity (Maximum) – Single Fusion (Standard Profile, 80810086), Single Fusion (Deep Profile, LGSTS72), Mass Fusion (Deep Profile, LGSTR216)		324, 432, N/A
Number of Splice Trays – 80810086, LGSTS72, LGSTR216		9, 6, N/A
Cable Ports <sup>1</sup>		4
Cable Diameters	Small Base	0.093" – 0.60" (2.4 – 15.2 mm) and Flat Drop
	Large Base	0.093" – 1.25" (2.4 – 31.8 mm) and Flat Drop
Ground Studs		4
Configuration		Butt
Cable Types		Buffer Tube Only
Application		Pedestal
Ingress Protection		In accordance with Telcordia® GR-771-CORE, Pedestal; IP-68
Size <sup>2</sup>		15.4" L x 15.4" W x 31.6" H (390 x 390 x 800 mm)
Kit	COYGLC-F6-000	Includes (1) Standard Platform
Contents <sup>3</sup>	COYGLC-F6-100	Includes (1) Platform with Cutout and (1) Grounding Spacer Kit

<sup>1</sup> Multi-hole grommets allow for more than one cable to enter each cable port

<sup>2</sup> Includes platform, collar, and dome assembly only. See COYOTE GLC Bases for base sizes

<sup>3</sup> All kits include (1) Green GLC Dome, (1) COYOTE 9.5" End Plate with Organizer, (1) Gasket, (1) Collar, (2) 1-Hole Grommets 0.60" – 0.85" (15.2 – 21.6 mm), (1) 2-Hole Grommet, (1) 7-Hole Grommet, (1) Splice Tray (Catalog Number: LGSTS72) and Cable Restraint Hardware.

## SPECIFICATIONS

9.5" x 28" GLC Cross-Connect Organizer

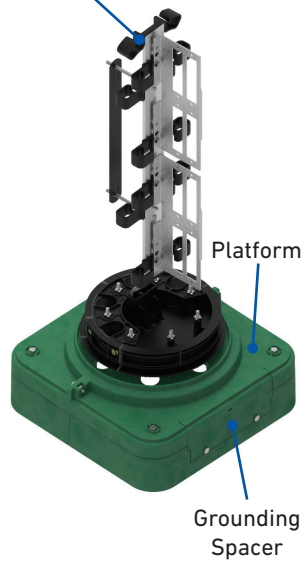

### COYOTE 9.5" x 28" GLC with Cross-Connect Organizer

Catalog Numbers		COYGLC-F7-000, COYGLC-F7-100
Splice Capacity (Maximum) – Single Fusion (Standard Profile, 80810086), Single Fusion (Deep Profile, LGSTS72), Mass Fusion (Deep Profile, LGSTR216)		180, 288, N/A
Number of Splice Trays – 80810086, LGSTS72, LGSTR216		5, 4, N/A
Cable Ports <sup>1</sup>		4
Cable Diameters	Small Base	0.093" – 0.60" (2.4 – 15.2 mm) and Flat Drop
	Large Base	0.093" – 1.25" (2.4 – 31.8 mm) and Flat Drop
Ground Studs		4
Configuration		Butt
Cable Types		Buffer Tube or Ribbon
Application		Pedestal
Ingress Protection		In accordance with Telcordia® GR-771-CORE, Pedestal; IP-68
Size <sup>2</sup>		15.4" L x 15.4" W x 31.6" H (390 x 390 x 800 mm)
Adapter Port Quantity (Maximum)		96 SC or 196 LC
Kit Contents <sup>3</sup>	COYGLC-F7-000	Includes (1) Standard Platform
	COYGLC-F7-100	Includes (1) Platform with Cutout and (1) Grounding Spacer Kit

<sup>1</sup> Multi-hole grommets allow for more than one cable to enter each cable port

<sup>2</sup> Includes platform, collar, and dome assembly only. See COYOTE GLC Bases for base sizes

<sup>3</sup> All kits include (1) Green GLC Dome, (1) COYOTE 9.5" End Plate with Organizer, (1) Gasket, (1) Collar, (2) 1-Hole Grommets 0.60" – 0.85" (15.2 – 21.6 mm), (1) 2-Hole Grommet, (1) 7-Hole Grommet, (1) Splice Tray (**Catalog Number LGSTS72**) and Cable Restraint Hardware. Additional selections of adapter and pigtail accessories are required.

## COYOTE GLC BASE AND COVER



COYOTE GLC Small Base  
17" W x 17" L x 13" H (430 x 430 x 330 mm)  
For Fiber Optic Cables with Diameters  
up to 0.60" (15.2 mm)  
**Catalog Number: COYGLC-B-000**

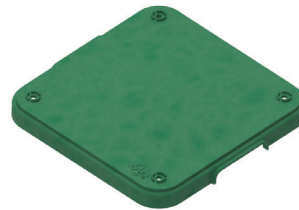

COYOTE GLC Small Base Cover  
**NOTE:** Can not be used as a plug  
for the large base cover  
**Catalog Number: 80809781**

## COYOTE® GLC SPACERS



**Standard Spacer**  
Raises the base height by 3" for adjustment to ground level

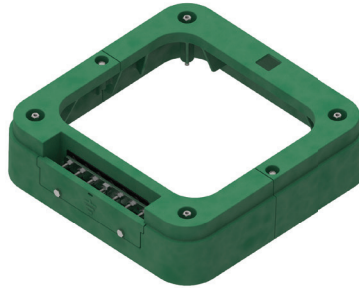

**Grounding Spacer**  
Raises the base height by 3" for adjustment to ground level. Provides 7 external isolated ground connections



**Dual Grounding Spacer**  
Raises the base height by 3" for adjustment to ground level. Provides 14 external isolated ground connections

### COYOTE GLC Spacers for Small Base

Catalog Number	Description
COYGLC-S1-000	COYOTE GLC Standard Spacer for Small Base – Includes (2) Standard Spacer Halves, (2) Self-Tapping Bolts, and (4) 3.49" L (89 mm) Spacer Fasteners
COYGLC-S2-000	COYOTE GLC Grounding Spacer for Small Base – Includes (1) Standard Spacer Half, (1) Grounding Spacer Half, (1) Ground Stud Mounting Plate, (7) Ground Studs with Fasteners, (1) Bonding Plate, (1) Standard Access Cover, (7) Ground Lead Assemblies, (2) Self-Tapping Bolts, and (4) 3.49" L (89 mm) Spacer Fasteners
COYGLC-S3-000	COYOTE GLC Dual Grounding Spacer for Small Base – Includes (2) Grounding Spacer Halves, (2) Ground Stud Mounting Plate, (14) Ground Studs with Fasteners, (2) Bonding Plate, (2) Standard Access Cover, (14) Ground Lead Assemblies, (2) Self-Tapping Bolts, and (4) 3.49" L (89 mm) Spacer Fasteners



COYOTE GLC without Grounding Spacer



COYOTE GLC with Grounding Spacer



## ACCESSORIES FOR CROSS-CONNECT APPLICATIONS

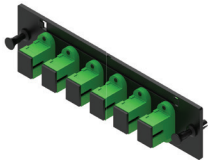

**6-Port SC/APC Adapter Module**

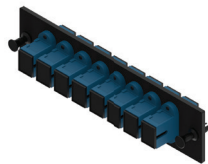

**8-Port SC/UPC Adapter Module**

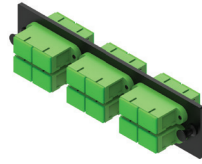

**12-Port SC/APC Adapter Module**

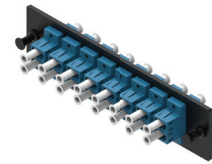

**16-Port LC/UPC Adapter Module**

### COYOTE Adapter Modules

Catalog Number	Description
6SCAPC	Adapter Kit – Includes (1) 6-Port SC/APC Adapter Module
8SCAPC	Adapter Kit – Includes (1) 8-Port SC/APC Adapter Module
12SMDSCA	Adapter Kit – Includes (1) 12-Port SC/APC Adapter Module
6SMSC	Adapter Kit – Includes (1) 6-Port SC/UPC Adapter Module
8SMSC	Adapter Kit – Includes (1) 8-Port SC/UPC Adapter Module
12SMDSC	Adapter Kit – Includes (1) 12-Port SC/UPC Adapter Module
12SMLCA	Adapter Kit – Includes (1) 12-Port LC/APC Adapter Module
16SMLCA	Adapter Kit – Includes (1) 16-Port LC/APC Adapter Module
24LCAPC	Adapter Kit – Includes (1) 24-Port LC/APC Adapter Module
12SMLC	Adapter Kit – Includes (1) 12-Port LC/UPC Adapter Module
16SMLC	Adapter Kit – Includes (1) 16-Port LC/UPC Adapter Module
24SMLC	Adapter Kit – Includes (1) 24-Port LC/UPC Adapter Module

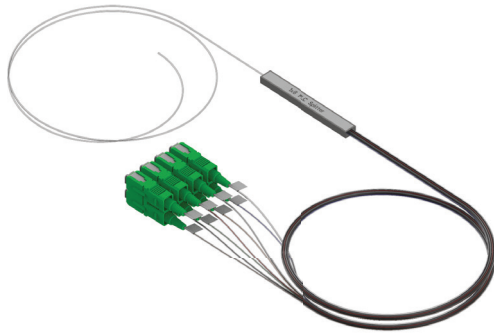

**1x8 SC/APC PLC Pre-Connectorized Splitter**

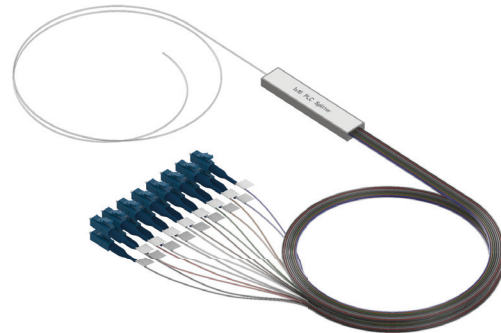

**1x16 LC/UPC PLC Pre-Connectorized Splitter**

### COYOTE GLC Pre-Connectorized Splitters

Catalog Number	Description
COYGLC-1X8-SCA	Pre-Connectorized Splitter – 1x8 SC/APC with 24" Output Legs
COYGLC-1X16-SCA	Pre-Connectorized Splitter – 1x16 SC/APC with 24" Output Legs
COYGLC-1X32-SCA	Pre-Connectorized Splitter – 1x32 SC/APC with 24" Output Legs
COYGLC-1X8-SCU	Pre-Connectorized Splitter – 1x8 SC/UPC with 24" Output Legs
COYGLC-1X16-SCU	Pre-Connectorized Splitter – 1x16 SC/UPC with 24" Output Legs
COYGLC-1X32-SCU	Pre-Connectorized Splitter – 1x32 SC/UPC with 24" Output Legs
COYGLC-1X8-LCA	Pre-Connectorized Splitter – 1x8 LC/APC with 24" Output Legs
COYGLC-1X16-LCA	Pre-Connectorized Splitter – 1x16 LC/APC with 24" Output Legs
COYGLC-1X32-LCA	Pre-Connectorized Splitter – 1x32 LC/APC with 24" Output Legs
COYGLC-1X8-LCU	Pre-Connectorized Splitter – 1x8 LC/UPC with 24" Output Legs
COYGLC-1X16-LCU	Pre-Connectorized Splitter – 1x16 LC/UPC with 24" Output Legs
COYGLC-1X32-LCU	Pre-Connectorized Splitter – 1x32 LC/UPC with 24" Output Legs

## ACCESSORIES FOR CROSS-CONNECT APPLICATIONS

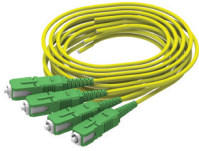

**2 mm Jacketed SC/APC  
Pigtails with Short  
Connector Boots**

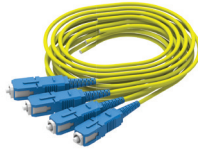

**2 mm Jacketed SC/UPC  
Pigtails with Short  
Connector Boots**



**2 mm Jacketed LC/APC  
Pigtails with Short  
Connector Boots**



**2 mm Jacketed LC/UPC  
Pigtails with Short  
Connector Boots**

### COYOTE 2 mm Jacketed Fiber Pigtail Kits - Short Boot Connectors

Catalog Number	Description
COYTRM-2PK-SCA-SB	Pigtail Kit – Includes (2) 2 mm SC/APC Jacketed Fiber Pigtails with Short Boot Connectors, 2 meters Long
COYTRM-3PK-SCA-SB	Pigtail Kit – Includes (3) 2 mm SC/APC Jacketed Fiber Pigtails with Short Boot Connectors, 2 meters Long
COYTRM-4PK-SCA-SB	Pigtail Kit – Includes (4) 2 mm SC/APC Jacketed Fiber Pigtails with Short Boot Connectors, 2 meters Long
COYTRM-2PK-SCU-SB	Pigtail Kit – Includes (2) 2 mm SC/UPC Jacketed Fiber Pigtails with Short Boot Connectors, 2 meters Long
COYTRM-3PK-SCU-SB	Pigtail Kit – Includes (3) 2 mm SC/UPC Jacketed Fiber Pigtails with Short Boot Connectors, 2 meters Long
COYTRM-4PK-SCU-SB	Pigtail Kit – Includes (4) 2 mm SC/UPC Jacketed Fiber Pigtails with Short Boot Connectors, 2 meters Long
COYTRM-4PK-LCA-SB	Pigtail Kit – Includes (4) 2 mm LC/APC Jacketed Fiber Pigtails with Short Boot Connectors, 2 meters Long
COYTRM-4PK-LCU-SB	Pigtail Kit – Includes (4) 2 mm LC/UPC Jacketed Fiber Pigtails with Short Boot Connectors, 2 meters Long

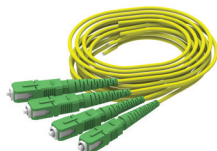

**2 mm Jacketed SC/APC  
Pigtails with Standard  
Connector Boots**



**2 mm Jacketed SC/UPC  
Pigtails with Standard  
Connector Boots**



**2 mm Jacketed LC/APC  
Pigtails with Standard  
Connector Boots**

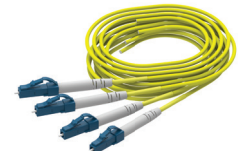

**2 mm Jacketed LC/UPC  
Pigtails with Standard  
Connector Boots**

### COYOTE 2 mm Jacketed Fiber Pigtail Kits - Standard Boot Connectors

Catalog Number	Description
COYTRM-2PK-SCA	Pigtail Kit – Includes (2) 2 mm SC/APC Jacketed Fiber Pigtails with Standard Boot Connectors, 2 meters Long
COYTRM-3PK-SCA	Pigtail Kit – Includes (3) 2 mm SC/APC Jacketed Fiber Pigtails with Standard Boot Connectors, 2 meters Long
COYTRM-4PK-SCA	Pigtail Kit – Includes (4) 2 mm SC/APC Jacketed Fiber Pigtails with Standard Boot Connectors, 2 meters Long
COYTRM-2PK-SCU	Pigtail Kit – Includes (2) 2 mm SC/UPC Jacketed Fiber Pigtails with Standard Boot Connectors, 2 meters Long
COYTRM-3PK-SCU	Pigtail Kit – Includes (3) 2 mm SC/UPC Jacketed Fiber Pigtails with Standard Boot Connectors, 2 meters Long
COYTRM-4PK-SCU	Pigtail Kit – Includes (4) 2 mm SC/UPC Jacketed Fiber Pigtails with Standard Boot Connectors, 2 meters Long
COYTRM-4PK-LCA	Pigtail Kit – Includes (4) 2 mm LC/APC Jacketed Fiber Pigtails with Standard Boot Connectors, 2 meters Long
COYTRM-4PK-LCU	Pigtail Kit – Includes (4) 2 mm LC/UPC Jacketed Fiber Pigtails with Standard Boot Connectors, 2 meters Long

## ACCESSORIES FOR CROSS-CONNECT APPLICATIONS

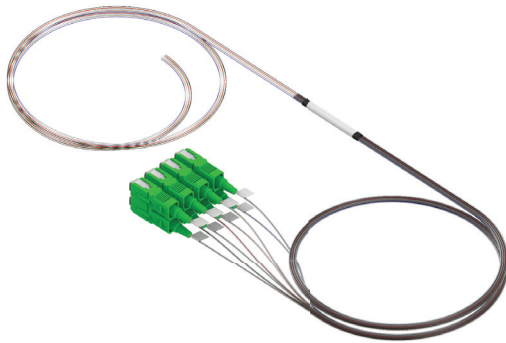

8 Fiber SC/APC GLC Pigtail Bundle

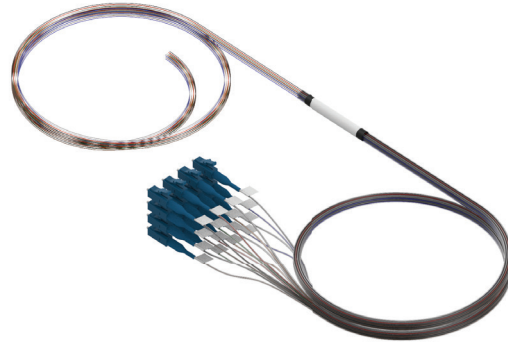

16 Fiber LC/UPC GLC Pigtail Bundle

### COYOTE GLC Pigtail Bundles

Catalog Number	Description
COYGLC-4FB-SCA	GLC Pigtail Bundle – Includes (4) SC/APC 900 μm Pigtails with 24" Output Legs
COYGLC-8FB-SCA	GLC Pigtail Bundle – Includes (8) SC/APC 900 μm Pigtails with 24" Output Legs
COYGLC-12FB-SCA	GLC Pigtail Bundle – Includes (12) SC/APC 900 μm Pigtails with 24" Output Legs
COYGLC-16FB-SCA	GLC Pigtail Bundle – Includes (16) SC/APC 900 μm Pigtails with 24" Output Legs
COYGLC-32FB-SCA	GLC Pigtail Bundle – Includes (32) SC/APC 900 μm Pigtails with 24" Output Legs
COYGLC-4FB-SCU	GLC Pigtail Bundle – Includes (4) SC/UPC 900 μm Pigtails with 24" Output Legs
COYGLC-8FB-SCU	GLC Pigtail Bundle – Includes (8) SC/UPC 900 μm Pigtails with 24" Output Legs
COYGLC-12FB-SCU	GLC Pigtail Bundle – Includes (12) SC/UPC 900 μm Pigtails with 24" Output Legs
COYGLC-16FB-SCU	GLC Pigtail Bundle – Includes (16) SC/UPC 900 μm Pigtails with 24" Output Legs
COYGLC-32FB-SCU	GLC Pigtail Bundle – Includes (32) SC/UPC 900 μm Pigtails with 24" Output Legs
COYGLC-4FB-LCA	GLC Pigtail Bundle – Includes (4) LC/APC 900 μm Pigtails with 24" Output Legs
COYGLC-8FB-LCA	GLC Pigtail Bundle – Includes (8) LC/APC 900 μm Pigtails with 24" Output Legs
COYGLC-12FB-LCA	GLC Pigtail Bundle – Includes (12) LC/APC 900 μm Pigtails with 24" Output Legs
COYGLC-16FB-LCA	GLC Pigtail Bundle – Includes (16) LC/APC 900 μm Pigtails with 24" Output Legs
COYGLC-32FB-LCA	GLC Pigtail Bundle – Includes (32) LC/APC 900 μm Pigtails with 24" Output Legs
COYGLC-4FB-LCU	GLC Pigtail Bundle – Includes (4) LC/UPC 900 μm Pigtails with 24" Output Legs
COYGLC-8FB-LCU	GLC Pigtail Bundle – Includes (8) LC/UPC 900 μm Pigtails with 24" Output Legs
COYGLC-12FB-LCU	GLC Pigtail Bundle – Includes (12) LC/UPC 900 μm Pigtails with 24" Output Legs
COYGLC-16FB-LCU	GLC Pigtail Bundle – Includes (16) LC/UPC 900 μm Pigtails with 24" Output Legs
COYGLC-32FB-LCU	GLC Pigtail Bundle – Includes (32) LC/UPC 900 μm Pigtails with 24" Output Legs

### COYOTE Field Installable Connectors

Catalog Number	Description
80813501	Field Installable Connector Kit – Includes (6) SC/APC Field Installable Connectors
80813502	Field Installable Connector Kit – Includes (12) SC/APC Field Installable Connectors
80813503	Field Installable Connector Kit – Includes (6) SC/UPC Field Installable Connectors
80813504	Field Installable Connector Kit – Includes (12) SC/UPC Field Installable Connectors
80813505	Field Installable Connector Kit – Includes (6) LC/APC Field Installable Connectors
80813506	Field Installable Connector Kit – Includes (12) LC/APC Field Installable Connectors
80813507	Field Installable Connector Kit – Includes (6) LC/UPC Field Installable Connectors
80813508	Field Installable Connector Kit – Includes (12) LC/UPC Field Installable Connectors

## ACCESSORIES FOR OPTITAP® APPLICATIONS



OptiTap Adapter



Hardened Adapter Installation Tool

### Hardened Adapter Accessories

Catalog Number	Description
8003715	Hardened Adapter Kit – Includes (1) OptiTap Adapter and (1) Installation Tool
8004115	Bulk Pack of OptiTap Adapters – Includes (10) OptiTap Adapters
80807972	Hardened Adapter Installation Tool
8003724	Port Plug Kit – Included (1) Port Plug and (1) Installation Tool
8004060	Bulk Pack of Port Plugs – Includes (10) Port Plugs

## ACCESSORIES



Retention Stake with Anchor Plate

### COYOTE GLC Accessories

Catalog Number	Description
80809958	Splice Tray, COYOTE LITE-GRIP® Short, Low Profile, 24 CT., Single Fusion
80813152	Splice Tray, COYOTE LITE-GRIP Short, Low Profile, 36 CT., Single Fusion
80808945	Splice Tray, COYOTE LITE-GRIP Short, Deep Profile, 40 CT., Single Fusion
LGSTR144	Splice Tray, COYOTE LITE-GRIP Short, Deep Profile, 144 CT., Mass Fusion
80810086	Splice Tray, COYOTE LITE-GRIP Long, Standard Profile, 36 CT., Single Fusion
LGSTS72	Splice Tray, COYOTE LITE-GRIP Long, Deep Profile, 72 CT., Single Fusion
LGSTR216	Splice Tray, COYOTE LITE-GRIP Long, Deep Profile, 216 CT., Mass Fusion
8004160	Heat Shrink Splice Protector Kit – Includes (50) 40 mm Mass Fusion
8004095	Heat Shrink Splice Protector Kit – Includes (50) 40 mm Single Fusion
8003717	Heat Shrink Splice Protector Kit – Includes (50) 60 mm Single Fusion
80809788	Retention Stake with Anchor Plate for Small Base 42" (1066 mm)
80803989	Shield Connector
80808613	Express Fiber Storage Ring for Deep Profile LITE-GRIP Splice Trays
80809205	Strength Member Bracket Kit – Includes (2) Short L-Brackets
80808651	Strength Member Bracket Kit – Includes (4) Long L-Brackets
80811037	4-Port Cable Retention Bobbin Kit
80811036	6-Port Drop Cable Retention Bobbin Kit
80812928	6/8-Port Drop Cable Retention Bobbin Kit

OptiTap® is a registered trademark of Corning Cable Systems.

CO-CA-1004-20