

# COYOTE<sup>®</sup> FIBER OPTIC SOLUTIONS

Fiber Optic Closures | Pedestals | Pre-Terminated Cabinets | NIDs | Connectivity Solutions



## ABOUT PLP

PLP's line of COYOTE® fiber optic closures, pedestals, cabinets, demarcation units, accessories and connectivity solutions trace their roots back to 1995 with the launch of the very first COYOTE Closure. Shortly thereafter, the product line expanded beyond the original closure to include smaller fiber count products, such as the COYOTE PUP and RUNT. Then, through additional field feedback, research, engineering, and development came a whole new breed of fiber optic closures – PLP's second generation of COYOTE products.

Just as the COYOTE Closure was groundbreaking technology in 1995, the patented segmented end plate and silicone grommet system of the second-generation COYOTE products made a similar industry-changing debut in 2004. Forever altering how fiber optic technicians and engineers approach installations when servicing or scaling a network, the new segmented end plate design provided independent access to each cable port without disrupting surrounding cables. The range-taking ability of the silicone grommet system, paired with the chemically bonded hard and soft polymer of the end plate cap, provides a secure seal around a wide variety of cable profiles, eliminating the need for scuffing, adhesives, sealing tapes, or cure times.

Two decades of innovation later, this technology now provides PLP with an array of outside plant closures for trunk, feeder, distribution, drop, and entrance applications which are compatible with loose tube, micro tube, tight-buffer, drop, buffered ribbon, uni-tube ribbon, ADSS, OPGW, and blown fiber optic cables.

All of PLP's outside plant closures are designed, engineered, and tested in accordance with the Telcordia® GR-771-CORE Generic Requirements for Fiber Splice Closures, providing the highest level of protection for your network. The COYOTE brand has become synonymous with quality, strength, and reliability, while also expanding to include dozens of new products and thousands of components - making it one of PLP's largest and most successful lines.

PLP serves all segments of the telecommunications industry including network operators, broadband service providers, enterprise networks, governmental agencies, educational institutions, and electric utilities deploying fiber optics.

Telcordia® is a registered trademark of Telcordia Technologies, Inc., now part of Ericsson.



# BUILD AMERICA, BUY AMERICA (BABA) COMPLIANT

## BUILD AMERICA, BUY AMERICA (BABA) COMPLIANT

Our state-of-the-art plants in **Arkansas**, **North Carolina**, and **Ohio** manufacture thousands of class-leading components used in communications and power networks worldwide, including producing the world's highest-quality fiber optic splice closures, pedestals, and pole line hardware devices. Many of these American-made, BABA-compliant products are needed for critical infrastructure projects in the U.S. and abroad, including projects that receive funding from the U.S. BEAD Program and other infrastructure spending initiatives.



Scan to learn more about BABA-compliant products.



## ROBOTIC MACHINERY ENHANCEMENTS

PLP continues to aggressively pursue world class lean manufacturing operations including the addition of robotic machinery to allow for more consistent applications as well as reducing repetitive motions for operators.



## QUALITY PRODUCTS, SHORTER LEAD TIMES

Most of the COYOTE® Fiber Optic closure and accessory line is manufactured at the Arkansas facility, allowing PLP to provide high quality products with shorter lead times, when compared to overseas manufacturers.

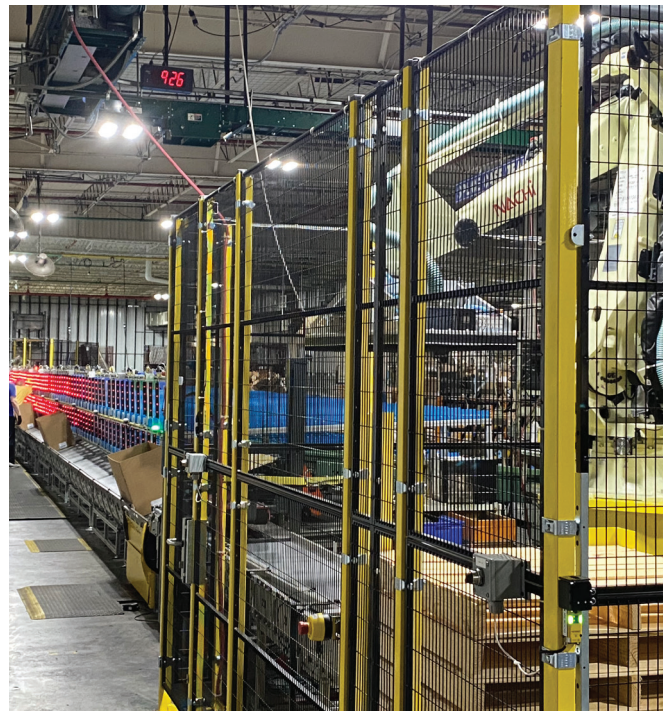

## CONTINUOUS IMPROVEMENT

When conducting business for fiber optic closures, small parts are a necessary means to complete the largest of splicing jobs. To ensure all small parts are packaged correctly in each fiber optic closure kit, PLP invested in a pick-to-light system. This system guides the packaging process by activating a light above each component required for the order. This process reduces the possibility of packaging errors and increases packing efficiency.



## TESTING & QUALITY CONTROL

Thomas Peterson, the founder of PLP, believed in innovation and quality. That's why product testing has been an integral part of PLP since its beginning in 1947. In fact, not only do we test products during the development stage in our research laboratory at PLP's global headquarters, we also test products at all our manufacturing facilities to ensure our quality is never compromised.

Today, our state-of-the-art lab is one of the largest testing facilities of fiber connectivity devices for the communications industry as well as conductor and cable accessories for the power utility industry. While many competitors have reduced or eliminated their testing labs, we recently expanded ours by 50 percent, making it a 23, 000 square foot facility.

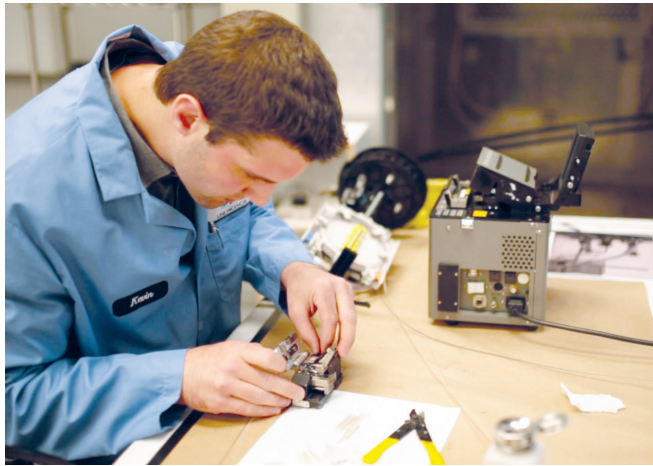

## HIGH STANDARDS

Quality begins at the receipt of materials when an incoming inspection is performed. This step ensures that PLP products start with high-quality materials, supplied from certified, pre-approved vendors.



## METICULOUS TESTING

During the development and production processes, we employ a variety of electrical, mechanical, chemical, functional, and environmental testing methods in accordance with Telcordia GR-771-CORE Generic Requirements for Fiber Splice Closures.

### TELCORDIA® COMPLIANT

*Quality control testing programs continue for fiber optic closures on a monthly, bi-monthly, and quarterly schedule ensuring that our products stay in line with Telcordia GR-771-CORE Generic Requirements for Fiber Splice Closures.*



## SALES CONTACTS



COMMUNICATIONS  
SALES



ELECTRIC UTILITY  
SALES

## CUSTOMER SUPPORT

Tel: 440.461.5200

Email: [info@plp.com](mailto:info@plp.com)

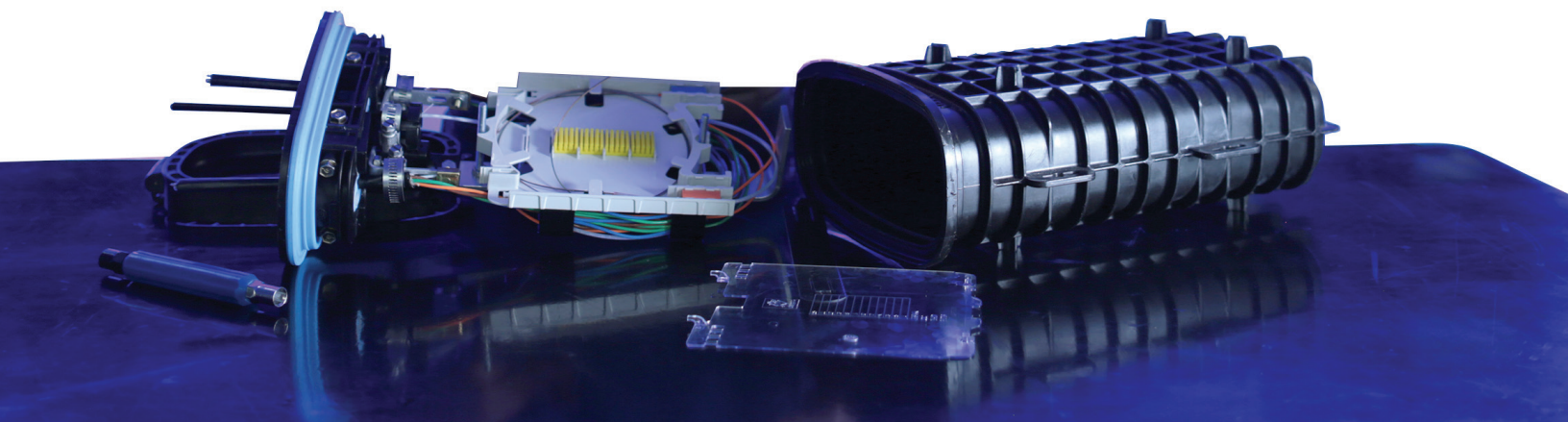

## CONTENTS

### COYOTE® FIBER OPTIC SOLUTIONS

#### SECTION 1 – DROP CLOSURES

COYOTE® STP (Service Termination Point).....	12
COYOTE® DRC (Drop Repair Closure) .....	14
COYOTE® DTC (Drop Termination Closure).....	16
COYOTE® DTC4/6 (Drop Termination Closure).....	18
COYOTE® DTC8 (Drop Termination Closure).....	20
COYOTE® Drop Cable Closure .....	22
COYOTE® LCC (Low Count Closure).....	24
COYOTE® BGC (Bonding and Grounding Closure) .....	26
COYOTE® STP-L.....	28
COYOTE® STP-XL.....	32
COYOTE® ATC (Aerial Terminal Closure).....	36
COYOTE® In-Line RUNT Closure.....	38

#### SECTION 2 – DOME CLOSURES

COYOTE® ONE Dome Closure.....	44
COYOTE® Dome Closure 6.5" x 17" and 6.5" x 22".....	48
COYOTE® Taut Closure .....	52
COYOTE® Dome Closure 9.5" x 19" and 9.5" x 28".....	54
COYOTE® HD (High-Density) Dome Closure .....	58
COYOTE® HD Stainless Steel Splice Case .....	64
COYOTE® Cross-Connect Closures .....	68

#### SECTION 3 – HARDENED CONNECTIVITY CLOSURES

COYOTE® STP-LT and XLT Terminal Closure.....	76
COYOTE® Terminal Closure.....	82
COYOTE® Terminal Dome Closure .....	86

#### SECTION 4 – PEDESTALS

COYOTE® 6" Pedestal.....	95
COYOTE® 8" Pedestal.....	96
COYOTE® 10" Pedestal .....	97
COYOTE® GLC (Ground Level Closure) .....	104

#### SECTION 5 – DEMARCATION

COYOTE® DEN2, DEN3, and DEN5 .....	116
COYOTE® MPC (Multi-Purpose Closure).....	122
COYOTE® PedBox®.....	126
COYOTE® ACE (Adaptable Connection Enclosure) .....	128
COYOTE® Access Solutions™ Fiber Wall Plate .....	130
COYOTE® Access Solutions™ Cabinets .....	132

#### SECTION 6 – CLOSURE ACCESSORIES

COYOTE® Passive Optical Components.....	140
COYOTE® PLC Splitters .....	145
COYOTE® Splice Trays .....	146
Sleeving and Tubing Kits for Cable Management.....	152
COYOTE® Silicone Grommets .....	154
COYOTE® Mounting Brackets Reference Guide .....	156

SECTION 7 – INDEX .....	162
-------------------------	-----



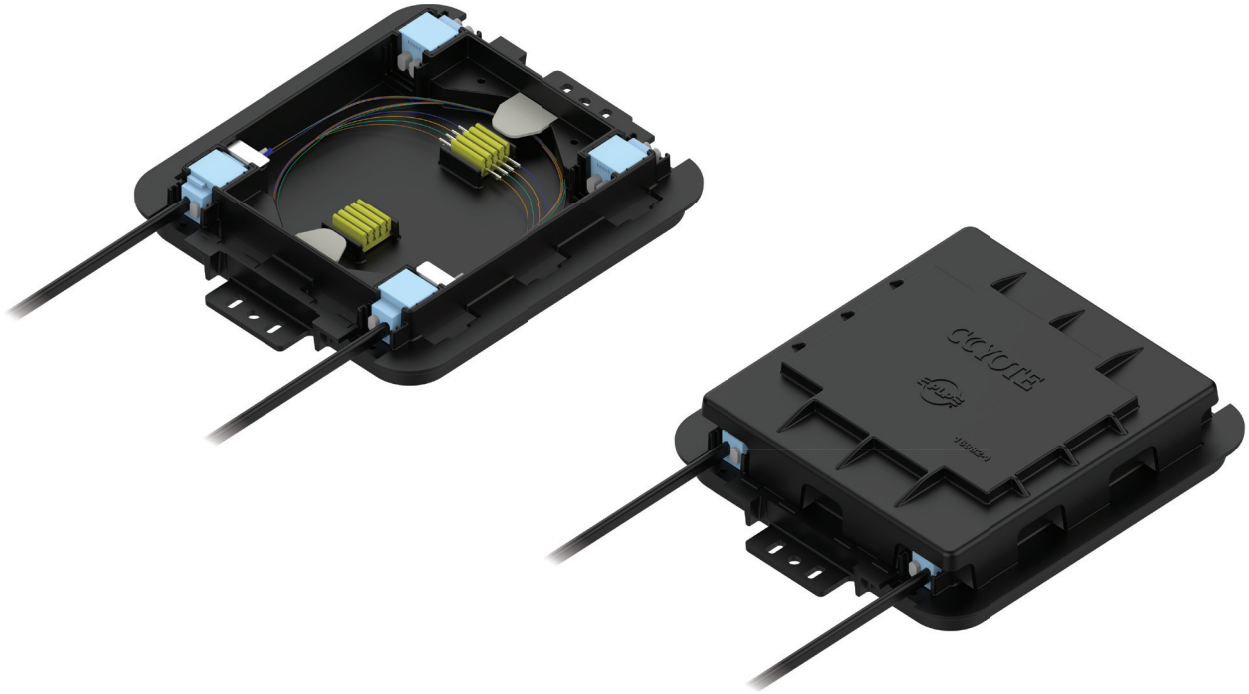

# SECTION 1 DROP CLOSURES

COYOTE® FIBER OPTIC SOLUTIONS

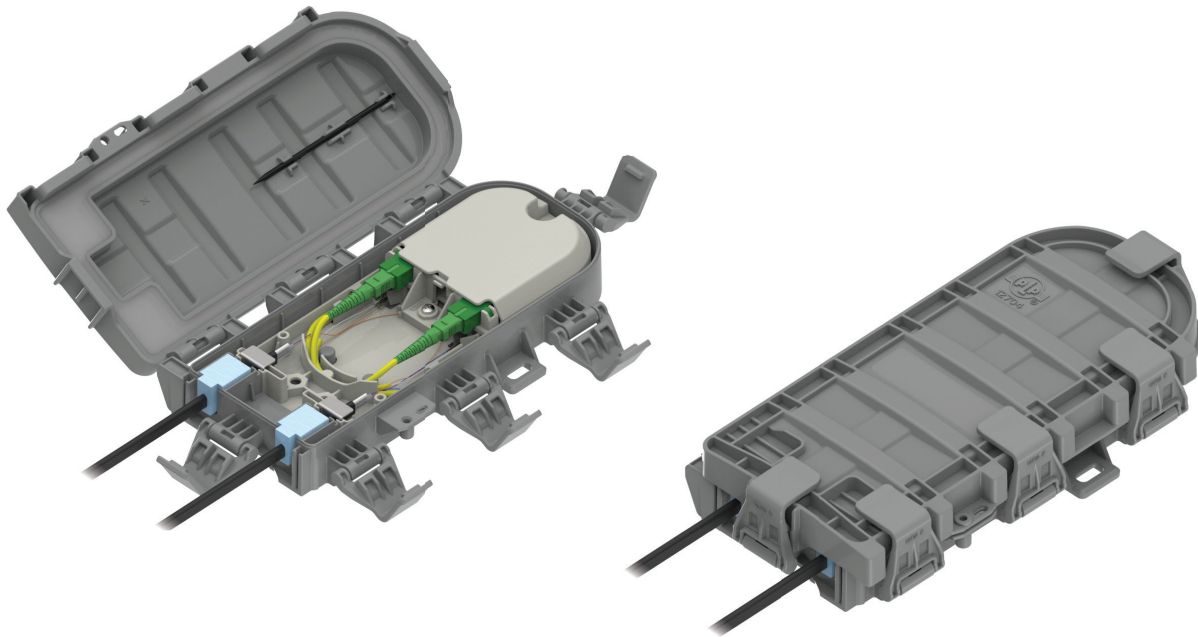

## COYOTE<sup>®</sup> STP

The **COYOTE STP (Service Termination Point)** is a small scale, cost effective closure which provides an alternative to traditional network interface devices, while offering much greater application flexibility. The robust latch system, paired with an integrated over-molded cover, allows for quick re-entry and creates a secure seal over a wide range of cable profiles. The COYOTE STP is ideal for use where the optical network terminal (ONT) is on the inside of a premises.

### FEATURES AND BENEFITS

- Dimensions: 10.1" x 5.0" x 1.9" (257 x 126 x 49 mm)
- Max Splice Capacity: 12 Single Fusion, 4 Mechanical
- Max Adapter Quantity: 2 Simplex SC or 2 Duplex LC
- Grommet Quantity: 2 (Multi-Hole Grommets Available)
- Grommet Cable Diameter Range: 0.100" – 0.425" (2.5 – 10.8 mm) Flat Drop and ROC™ Drop Cable
- Applications: Indoor/Outdoor Premises, Pedestal, Wall/Pole Network Interface Device (NID)
- Designed and tested in accordance with Telcordia<sup>®</sup> GR-771-CORE Above Grade, IP-67 Rated Requirements
- Constructed out of rugged UV-stabilized, flame-retardant material (UL94-5VA Rated)
- Robust latch system and integrated over-molded cover creates a secure seal and provides quick re-entry into the closure
- Removable splice platform allows splicing and connections to be made outside of the closure

# ORDERING INFORMATION

## COYOTE STP Catalog Number

**STP- XX - X - X - X - X**  
 (Section 1) (Section 2) (Section 3) (Section 4) (Section 5)

Must be in  
 alphabetical  
 order

Catalog Number Example: STP-GG-3-1-2-2

### Section 1

Grommet Selection (Select 2)	Cable Diameter Range
A	SOLID / PLUG
B	0.100" - 0.154" (2.5 - 3.9 mm) ROUND CABLES
C	0.154" - 0.250" (3.9 - 6.4 mm) ROUND CABLES
D	0.250" - 0.350" (6.4 - 8.9 mm) ROUND CABLES
E	0.350" - 0.389" (8.9 - 9.9 mm) ROUND CABLES
F	0.389" - 0.425" (9.9 - 10.8 mm) ROUND CABLES
G	FOR FLAT DROP CABLES
H	0.100" - 0.123" (2.5 - 3.1 mm) ROUND CABLES
J	0.154" - 0.188" (3.9 - 4.8 mm) ROUND CABLES
R	FOR ROC™ DROP CABLES (For Dielectric Drop Cables ONLY)

### Section 2

Organizer Options (Select 1)	
1	 Splice Only
2	 Splice with Bonding & Grounding
3	 Cross-Connect
4	 Cross-Connect with Bonding & Grounding
5	 Direct Cross-Connect

### Section 3

Adapter Type (Select 1)	
N	NONE
1	 SC/APC
2	 SC/UPC
3	 LC/APC
4	 LC/UPC

### Section 4

Adapter Quantity
0 to 2

### Section 5

Pigtails Required (Select 1) (Matches adapter type and quantity)	
N	NONE
1	 900 µm
2	 2 mm Jacketed

### Accessories

Catalog Number	Description
80061322	COYOTE STP External Shroud Kit
80061323	COYOTE STP Pedestal Mounting Bracket Kit for Charles Industries PEDLOCK® BD4 and BD5 Buried Cable Pedestals

PEDLOCK® is a registered trademark of Charles Industries Ltd.  
 ROC™ is a trademark of Corning Incorporated.

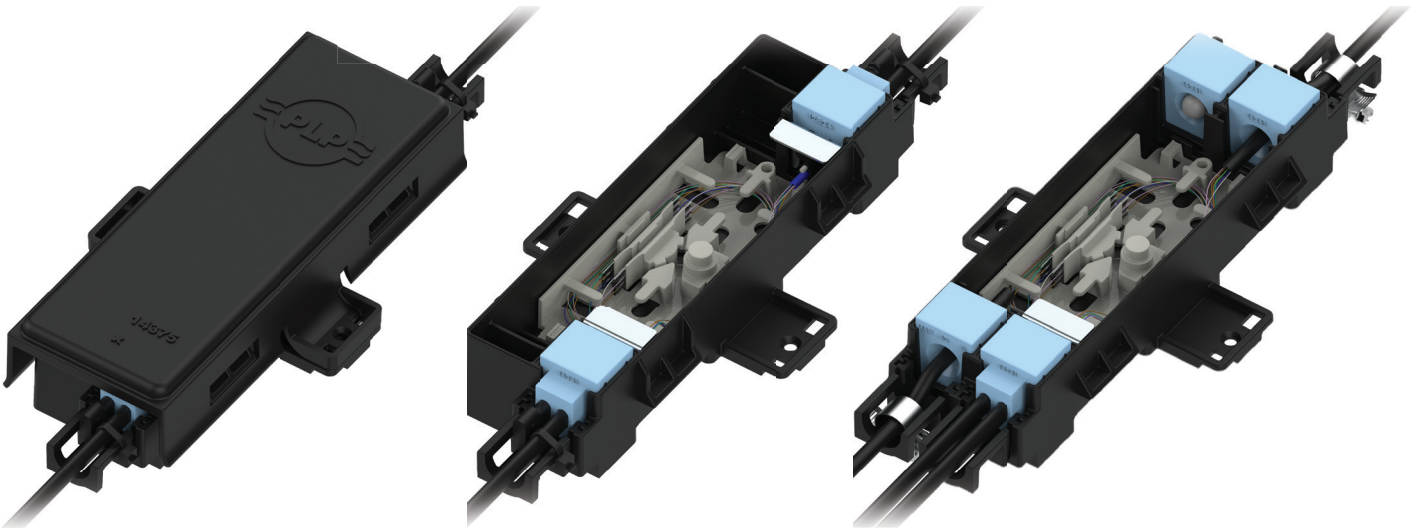

## COYOTE® DRC

### FOR G.657 BEND-INSENSITIVE FIBER ONLY

The **COYOTE DRC (Drop Repair Closure)** is engineered for fast, reliable restoration of damaged or cut fiber service drops in last-mile FTTH networks. Its compact footprint makes it easy to install in tight, congested, or hard-to-access locations without sacrificing performance or durability. Built with a rugged over-molded exterior, the DRC provides a secure, long-lasting seal that can be quickly assembled and re-entered in the field. The closure features grommet ports compatible with PLP's range taking conical and multi-hole grommets, allowing for versatile cable management and dependable environmental sealing across a wide variety of drop cable configurations.

### FEATURES AND BENEFITS

- Supports up to 6 single fusion, 12 mass fusion, or mechanical splices for versatile drop repair configurations
- Factory-installed gasket provides dependable environmental protection while allowing easy re-entry and repeated use
- Integrated splice platform neatly manages bare fiber and slack storage to maintain organization and reduce installation time
- Snap-together design enables fast assembly without the need for special tools
- Available in 2-port or 4-port configurations to accommodate a wide range of drop cable types and network layouts
- Designed and tested to Telcordia® GR-771-CORE requirements for buried and underground environments, including IP68-equivalent sealing and 3 ft (1 m) water submersion performance
- Optimized for use with G.657 bend-insensitive fiber

## COYOTE® DRC

Specifications	
Splice Capacity (Maximum) - Single Fusion, Mass Fusion	6 CT., 12 CT.
Cable Ports	2 or 4
Cable Diameters	0.17" - 0.32" (4.3 - 8.1 mm) Round, Flat Drop, and ROC™ Drop Cables
Configuration	In-Line or Butt <sup>1</sup>
Application	Direct Bury, Below Grade, Pole/Wall, Aerial, applications using G.657 fiber
Ingress Protection	In accordance to Telcordia® GR-771-CORE, Buried, Underground, IP-68 up to 3 ft (1 m) water submersion
Size	8.5" L x 3.8" W x 1.6" D (216 mm x 97 mm x 41 mm)

<sup>1</sup> Butt configuration only applicable in 4-Port design

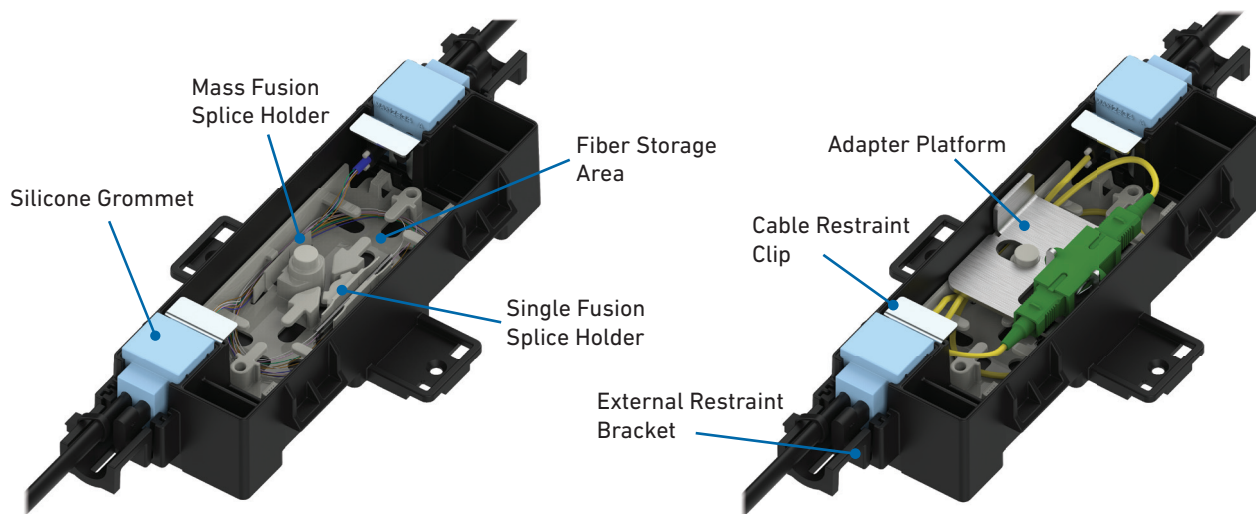

### COYOTE DRC Kit Contents

Catalog Number	Description
COYDRC2-001	COYOTE DRC2 for Flat/ROC™ Drop Cable Repair - Includes (2) 2-Hole Flat Drop Grommets, (2) 2-Hole ROC Drop Grommets, Splice Platform, and Cable Restraint Hardware
COYDRC2-002	COYOTE DRC2 for Round Drop Cable Repair - Includes (2) Small Conical Grommets 0.17" - 0.32" (4.3 mm - 8.1 mm), Splice Platform, and Cable Restraint Hardware
COYDRC4-001	COYOTE DRC4 for Flat/ROC Drop Cable Repair - Includes (2) 2-Hole Flat Drop Grommets, (2) 2-Hole ROC Drop Grommets, Splice Platform, and Cable Restraint Hardware
COYDRC4-002	COYOTE DRC4 for Round Drop Cable Repair - Includes (4) Small Conical Grommets 0.17" - 0.32" (4.3 mm - 8.1 mm), Splice Platform, and Cable Restraint Hardware

### COYOTE DRC Accessory Kits

Catalog Number	Description
8004279	Adapter Platform Kit - Includes (1) Adapter Platform, (1) Simplex SC/APC Adapter

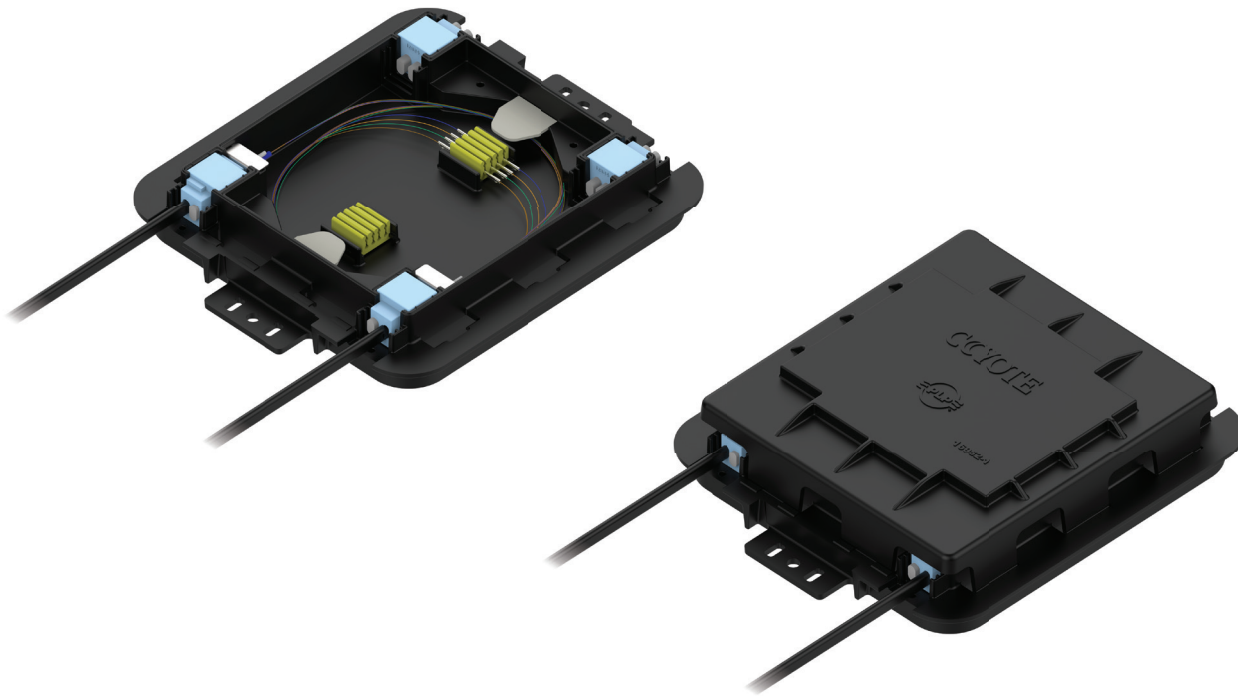

## COYOTE<sup>®</sup> DTC

The **COYOTE DTC (Drop Termination Closure)** offers a compact size and a rugged exterior that is designed to allow for installation in tight spaces without compromising functionality. Four corner ports provide flexibility during installation. The COYOTE DTC is ideal for quick restoration of damaged or cut fiber service drops or last mile FTTH applications.

### FEATURES AND BENEFITS

- Utilizes the LITE-GRIP<sup>®</sup> Splice Block System which permits single fusion, mass fusion, mechanical, PLC splitters, or a combination of all within one closure
- Factory-installed gasket allows re-entry and re-use
- Internal organizer manages buffer tube or ribbon cables
- Snap together design is quick to assemble, no special tools required
- Designed and tested in accordance with Telcordia<sup>®</sup> GR-771-CORE Buried, Underground, IP-68 Rated Requirements

## Specifications

Catalog Number	COYDTC-001, COYDTC-002, COYDTC-003, COYDTC-009
Splice Capacity (Maximum) - Single Fusion, Mass Fusion	24, 36
Cable Ports	4 <sup>1</sup>
Cable Diameters	0.17" – 0.32" (4.3 – 8.1 mm), Flat Drop, and ROC™ Drop Cable
Configuration	In-Line or Butt
Application	Direct Bury, Below Grade, Pole/Wall, Aerial
Ingress Protection	In accordance with Telcordia® GR-771-CORE, Buried, Underground, IP-68
Size	9.1" L x 7.6" W x 1.8" D (231 x 193 x 46 mm)

<sup>1</sup>Multiple cable entries per port.

## COYOTE DTC Kit Contents

Catalog Number	Description
COYDTC-001	COYOTE DTC for Flat and Small Drop Cables – Includes (2) 1-Hole Grommets 0.17" – 0.32" (4.3 – 8.1 mm) and (2) 2-Hole Flat Drop Grommets, (2) LITE-GRIP® Single Fusion Splice Blocks, (1) LITE-GRIP Mass Fusion Splice Block and Cable Restraint Hardware
COYDTC-002	COYOTE DTC for Larger Round Cables – Includes (4) 1-Hole Grommets 0.17" – 0.32" (4.3 – 8.1 mm), (2) LITE-GRIP Single Fusion Splice Blocks, (1) LITE-GRIP Mass Fusion Splice Block and Cable Restraint Hardware
COYDTC-003	COYOTE DTC for Larger Round Shielded Drop Cables – Includes (4) 1-Hole Grommets 0.17" – 0.32" (4.3 – 8.1 mm), (4) Small Hose Clamps, (4) Cable Retention Clips, (2) LITE-GRIP Single Fusion Splice Blocks, (1) LITE-GRIP Mass Fusion Splice Block, Cable Restraint Hardware, (4) Shield Continuity Clips and (2) Shield Continuity Wire Assemblies
COYDTC-009	COYOTE DTC for Corning ROC™ Drop Cables - Includes (4) 2-Hole Grommets for Corning ROC Drop Cable, (2) LITE-GRIP Single Fusion Splice Blocks, (1) LITE-GRIP Mass Fusion Splice Block and Cable Restraint Hardware

## COYOTE DTC Accessories

Catalog Number	Description
80821085	Splice Tray Kit – Includes (1) Splice Tray, (6) 12 CT. Splice Blocks, (1) Ribbon/ Splitter Block, (4) #6 Self-Tapping Screws, Zip Ties, and Felt Tape
80812533	Cover Opening Tool
80808187	Heat Shrink Splice Protector Kit – Includes (12) 40 mm Single Fusion
8003509	Heat Shrink Splice Protector Kit – Includes (12) 60 mm Single Fusion
8003993	Heat Shrink Splice Protector Kit – Includes (12) 40 mm Mass Fusion
80813362	Splice Block Kit – Includes (6) Plastic 12 CT. Single Fusion Splice Blocks, Orange
LGSBS8-5	Splice Block Kit – Includes (5) LITE-GRIP 8 CT. Single Fusion Splice Blocks, Yellow
LGSBR3-5	Splice Block Kit – Includes (5) LITE-GRIP 36 CT. Mass Fusion Splice Blocks, Purple

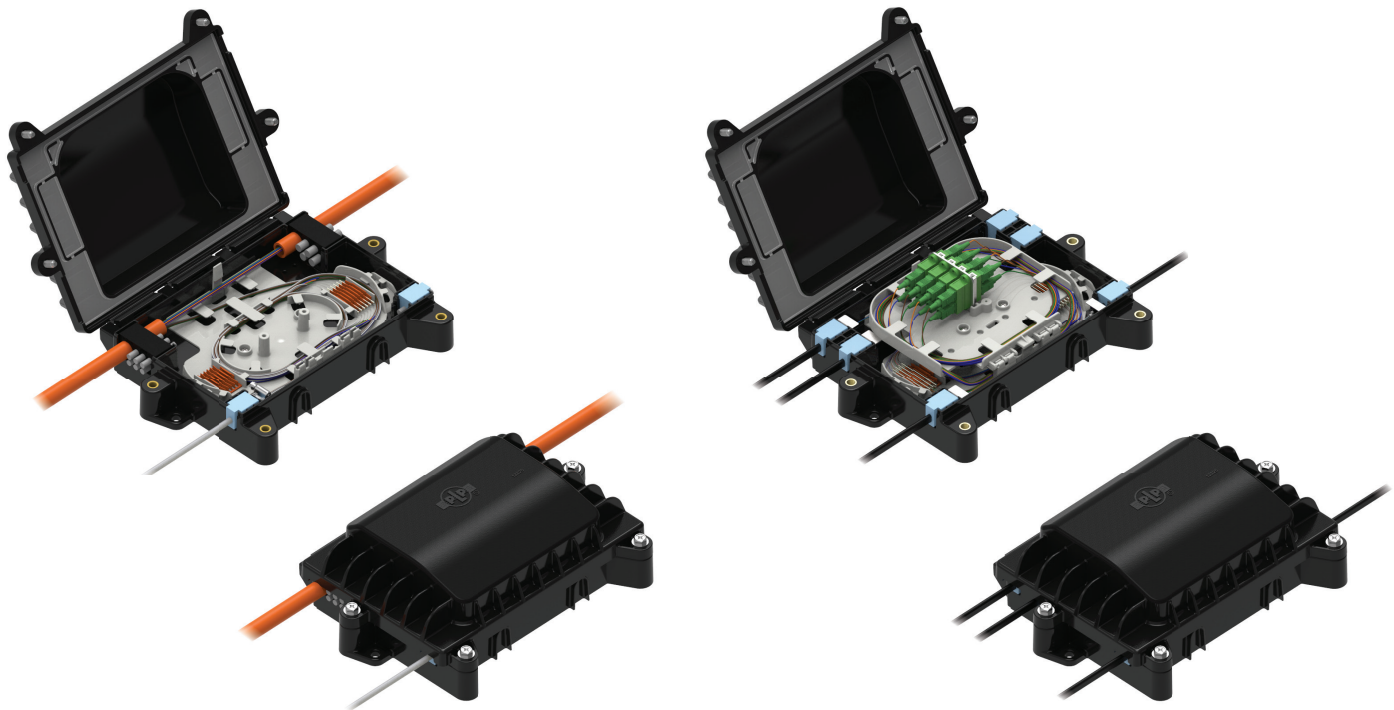

## COYOTE® DTC4 AND DTC6

The **COYOTE DTC4 and DTC6 (Drop Termination Closure)** offer a durable, compact solution with multiple internal fiber organizers to support your current and future needs. Network evolution is unpredictable so why not choose a closure system developed to adapt. The DTC4 can be used as a transition unit for interior duct applications. Both the COYOTE DTC4 and DTC6 can equip an adapter bulkhead tray that hinges to allow access to the underlying fiber slack storage area.

### FEATURES AND BENEFITS

- Dimensions: 10.8" x 7.8" x 3.2" (274 x 198 x 82 mm)
- Max Splice Capacity: 24 Single Fusion
- Max Adapter Quantity: 4 Dual SC or 4 Quad LC
- Grommet Quantity: 4 or 6 (Multi-Hole Grommets Available)
- Grommet Cable Diameter Range: Large Grommets = 0.118" – 0.60" (3 – 15 mm)  
Small Grommets = 0.093" – 0.420" (2.4 – 10.7 mm) Flat Drop and ROC™ Drop Cable
- Applications: Direct Bury, Below Grade, Pole/Wall Mount, Pedestal, Aerial, or Interior Applications
- Designed and tested in accordance with Telcordia® GR-771-CORE Buried, Underground, IP-68 Rated Requirements
- Constructed out of rugged UV-stabilized, flame-retardant material (UL94-5VA Rated)
- Hinged cover with integrated over-mold creates a secure seal and provides quick re-entry and re-use

## ORDERING INFORMATION

### COYOTE® DTC4 Catalog Number

**DTC4- XX - XX - X - X - X - X**  
 (Section 1) (Section 2) (Section 3) (Section 4) (Section 5) (Section 6)  
 Must be in alphabetical order      Must be in alphabetical order

Catalog Number Example: DTC4-AA-DD-2-1-2-N

### COYOTE® DTC6 Catalog Number

**DTC6- XXXXX - X - X - X - X**  
 (Section 2) (Section 3) (Section 4) (Section 5) (Section 6)  
 Must be in alphabetical order

Catalog Number Example: DTC6-AABBDD-2-2-2-Y

#### Section 1

DTC4 Large Grommet Selection (Select 2)	Cable Diameter Range
A	5-Hole Design 1 Hole: 0.55" – 0.60" (14 - 15 mm) 4 Holes: 0.275" (7 mm)
B	7-Hole Design 1 Hole: 0.55" – 0.60" (14 - 15 mm) 6 Holes: 0.197" (5 mm)
C	7-Hole Design 1 Hole: 0.335" (8.5 mm) 6 Holes: 0.197" (5 mm)
D	8-Hole Design 8 Holes: 0.197" (5 mm)
E	8-Hole Design 8 Holes: 0.118" (3 mm)

#### Section 2

DTC4 Small Grommet Selection (Select 2)	Cable Diameter Range
DTC6 Small Grommet Selection (Select 6)	
A	SOLID / PLUG
B	0.170" – 0.250" (4.3 - 6.4 mm) ROUND CABLES
C	0.250" – 0.350" (6.4 - 8.9 mm) ROUND CABLES
D	0.156" – 0.170" (4.0 - 4.3 mm) ROUND CABLES
E	0.093" – 0.125" (2.4 - 3.2 mm) ROUND CABLES
F	FOR FLAT DROP CABLES
G	0.350" – 0.420" (8.9 - 10.7 mm) ROUND CABLES
R	FOR ROC™ DROP CABLES (For Dielectric Drop Cables ONLY)

#### Section 3

Organizer Options (Select 1)	
1	Splice Only
2	Splice & Adapters

#### Section 4

Adapter Type (Select 1)	
N	NONE
1	 Duplex SC/APC
2	 Duplex SC/UPC
3	 Quad LC/APC
4	 Quad LC/UPC

#### Section 5

Adapter Quantity
0 to 4

#### Section 6

Pigtails Required (Select 1) (Matches adapter type and quantity)	
N	NONE
Y	 900 µm

#### Accessories

Catalog Number	Description
8004109	COYOTE DTC4/6 Pole/Wall Mounting Bracket
8004110	COYOTE DTC4/6 Cable Storage Bracket
8004111	COYOTE DTC4/6 Aerial Mounting Bracket – Strand Applications
8004112	COYOTE DTC4/6 Aerial Mounting Bracket – ADSS Applications
8004172	COYOTE DTC4/6 Mounting Bracket – For use with FIBERLIGN® ADSS Cable Storage Bracket



## COYOTE® DTC8

The **COYOTE DTC8 (Drop Termination Closure)** is the largest member of the DTC family. The DTC8 provides the ultimate level of application flexibility for fiber drop distribution applications. The closure can be configured with a range of fiber organizer systems to support splice, distributed splitter and drop applications using traditional cable, blown fiber cable, pushable drop cable technology or micro tube cable. Organizers to support pre-connected drop applications as an alternative to more costly proprietary hardened drop cable systems are also available.

### FEATURES AND BENEFITS

- Dimensions: 12" x 8.8" x 3.5" (305 x 224 x 89 mm)
- Max Splice Capacity: 48 Single Fusion
- Max Adapter Quantity: 4 Duplex SC or 4 Quad LC
- Grommet Quantity: 8 (Multi-Hole Grommets Available)
- Grommet Cable Diameter Range: Large Grommets = 0.093" – 0.550" (2.4 - 14.0 mm) Flat Drop and ROC™ Drop Cable  
Small Grommets = 0.093" – 0.420" (2.4 - 10.7 mm) Flat Drop and ROC™ Drop Cable
- Applications: Direct Bury, Below Grade, Pole/Wall Mount, Aerial, or Pedestal
- Designed and tested in accordance with Telcordia® GR-771-CORE Buried, Underground, IP-68 Rated Requirements
- Constructed out of rugged UV-stabilized, flame retardant material (UL94-5VA Rated)
- Hinged collar system and integrated over-molded cover provides quick re-entry and re-use, no special tools required

# ORDERING INFORMATION

## COYOTE® DTC8 Catalog Number

**DTC8- XXXX - XXXX - X - X - X - X - X**  
 (Section 1) (Section 2) (Section 3) (Section 4) (Section 5) (Section 6) (Section 7)  
 Must be in alphabetical order      Must be in alphabetical order  
 Catalog Number Example: DTC8-BBDD-CCCC-2-2-1-2-Y

### Section 1

Grommet Selection (Select 4)	Cable Diameter Range
A	SOLID / PLUG
B	0.170" – 0.220" (4.3 – 5.6 mm) ROUND CABLES
C	0.220" – 0.270" (5.6 – 6.9 mm) ROUND CABLES
D	0.270" – 0.320" (6.9 – 8.1 mm) ROUND CABLES
E	0.320" – 0.370" (8.1 – 9.4 mm) ROUND CABLES
F	0.370" – 0.420" (9.4 – 10.7 mm) ROUND CABLES
G	0.420" – 0.470" (10.7 – 11.9 mm) ROUND CABLES
H	0.470" – 0.550" (11.9 – 14.0 mm) ROUND CABLES
J	0.156" – 0.170" (4.0 – 4.3 mm) ROUND CABLES
K	0.093" – 0.125" (2.4 – 3.2 mm) ROUND CABLES
L	FOR FLAT DROP CABLES
R	FOR ROC™ DROP CABLES (For Dielectric Drop Cables ONLY)

### Section 2

Grommet Selection (Select 4)	Cable Diameter Range
A	SOLID / PLUG
B	0.170" – 0.250" (4.3 – 6.4 mm) ROUND CABLES
C	0.250" – 0.350" (6.4 – 8.9 mm) ROUND CABLES
D	0.156" – 0.170" (4.0 – 4.3 mm) ROUND CABLES
E	0.093" – 0.125" (2.4 – 3.2 mm) ROUND CABLES
F	FOR FLAT DROP CABLES
G	0.350" – 0.420" (8.9 – 10.7 mm) ROUND CABLES
R	FOR ROC™ DROP CABLES (For Dielectric Drop Cables ONLY)

ROC™ is a trademark of Corning Incorporated.

### Section 3

Organizer Options (Select 1)	
1	Splice Only - Protected Storage
2	Splice & Adapters
3	Splice Only - Open Storage
4	Adapters Only
5	Splice & Adapters - Open Storage

### Section 4

Splice Tray Selection Selection/Quantity	
N	NONE (Organizer 4 & 5)
1 to 4	 12 Count Tray

### Section 5

Adapter Type (Select 1)	
N	NONE
1	Duplex SC/APC
2	Duplex SC/UPC
3	Quad LC/APC
4	Quad LC/UPC

### Section 6

Adapter Quantity
0 to 4 (Organizer 2 or 5) 0 to 8 (Organizer 4)

### Section 7

Pigtails Required (Select 1) (Matches adapter type and quantity)	
N	NONE
Y	900 µm
Optional	
G	Ground Stud

### Accessories

Catalog Number	Description
80812456	Splice Tray, 12 CT., Single Fusion
80812916	Splitter Tray for 1x2, 1x4, 1x8 Bare Fiber Splitters or 1x2, 1x4 Pre-Connectorized Splitters
8004104	COYOTE DTC8 Pole/Wall Mounting Bracket
8004105	COYOTE DTC8 Cable Storage Bracket
8004111	COYOTE DTC8 Aerial Mounting Bracket – Strand Applications
8004112	COYOTE DTC8 Aerial Mounting Bracket – ADSS Applications
8004108	COYOTE DTC8 Pedestal Bracket Kit – For use with Channell Commercial Corp. 10" x 22" Round Pedestal
8004172	COYOTE DTC8 Mounting Bracket – For use with FIBERLIGN® ADSS Cable Storage Bracket

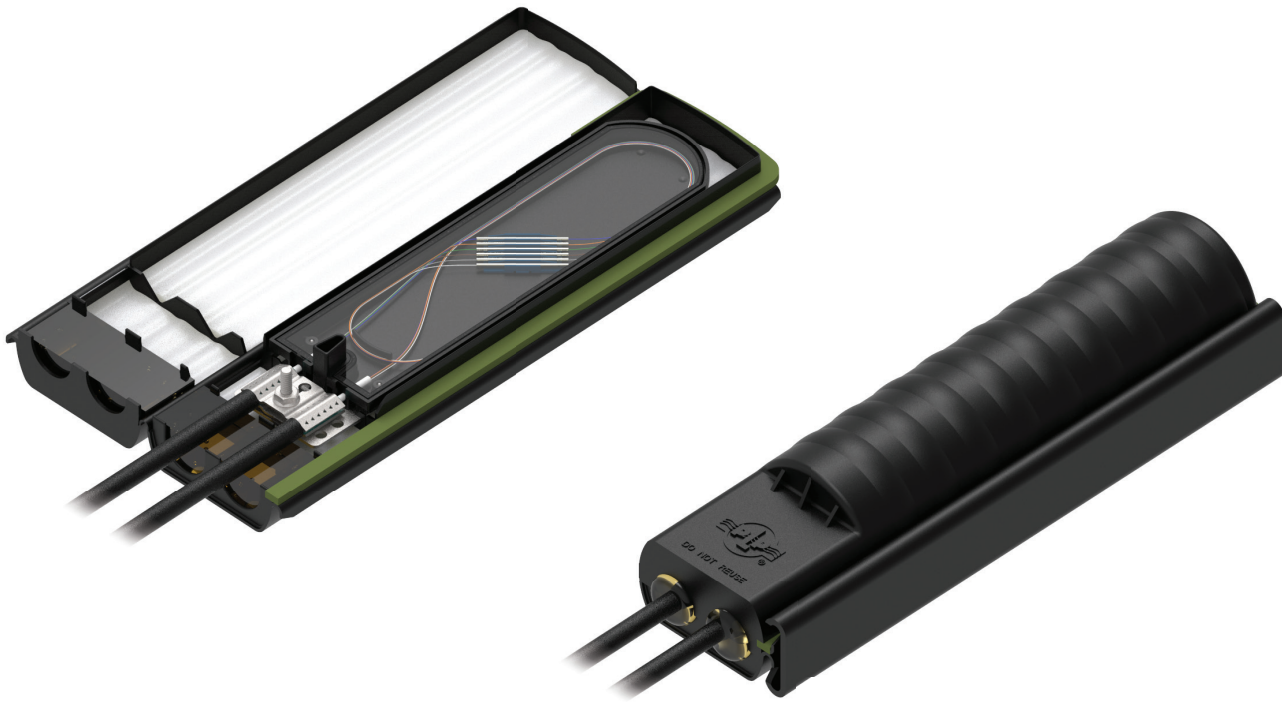

## COYOTE® DROP CABLE CLOSURE

The **COYOTE Drop Cable Closure** is a re-enterable, but not re-usable, encapsulant filled closure for splicing buried fiber optic drop cables with six fibers or less. The closure is factory filled with POLYBEE™ Sealant that encapsulates the sealed splice tray within the closure to provide long term protection against the harsh elements of the OSP environment. In addition to the encapsulant, the closure incorporates a water-blocking system that consists of a soft gel grommet to seal around the cables and a green sealant tape to seal the closure halves.

### FEATURES AND BENEFITS

- Can accept either dielectric or shielded drop cables up to 0.50" (12.7 mm) in diameter
- Sealed splice tray assembly with integrated bond clamp for restraining cables and providing conductivity between shielded cables
- Factory installed splice block on splice tray to house up to 6 single fusion splices – 40 mm heat shrink splice protectors are provided
- Factory filled closure with POLYBEE™ sealant to provide a protective barrier around the sealed splice tray assembly
- Closure sealant system that allows the closure to be re-entered but not re-used
- Flexible hinge closure design that uses a V-notched slider clamp to secure the closure halves together
- Unfilled version available for aerial applications that uses the same cable and closure sealant system to prevent ingress of wind-driven rain and dust
- Designed and tested in accordance with Telcordia® GR-771-CORE Buried, Underground, IP-68 Rated Requirements

## Specifications

<b>Catalog Numbers</b>	<b>8006876, 8006914</b>
Splice Capacity (Maximum) - Single Fusion	6
Cable Ports	2
Cable Diameters	0.50" (12.7 mm) or less
Configuration	Butt
Application	Direct Bury, Below Grade, Aerial, Pedestal
Ingress Protection	In accordance with Telcordia® GR-771-CORE, Buried, Underground, IP-68
Size	12" L x 3.5" W x 3" D (305 x 89 x 76 mm)

## COMPONENTS

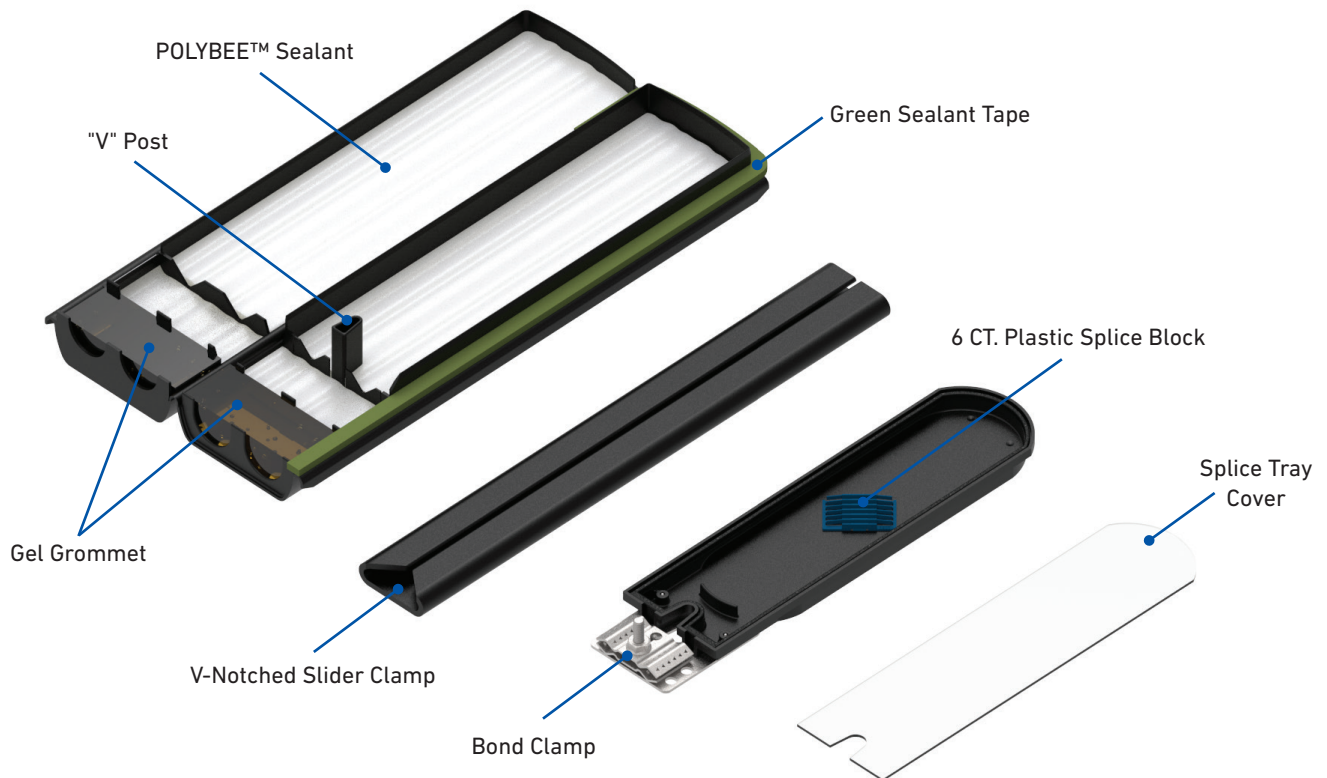

## COYOTE Drop Cable Closure Kit Contents

Catalog Number	Description
8006876	COYOTE Drop Cable Closure ( <b>Filled</b> ) – Includes (1) Filled Drop Cable Closure, (1) Slider Clamp, (1) 6 CT. Splice Tray for Single Fusion Splices, (6) 40 mm Heat Shrink Splice Protectors, (1) Roll of Sealant, & (2) Plastic Gloves
8006914	COYOTE Drop Cable Closure ( <b>Unfilled</b> ) for Aerial or Pedestal Use Only – Includes (1) Filled Drop Cable Closure, (1) Slider Clamp, (1) 6 CT. Splice Tray for Single Fusion Splices, (6) 40 mm Heat Shrink Splice Protectors, (1) Roll of Sealant, & (2) Plastic Gloves

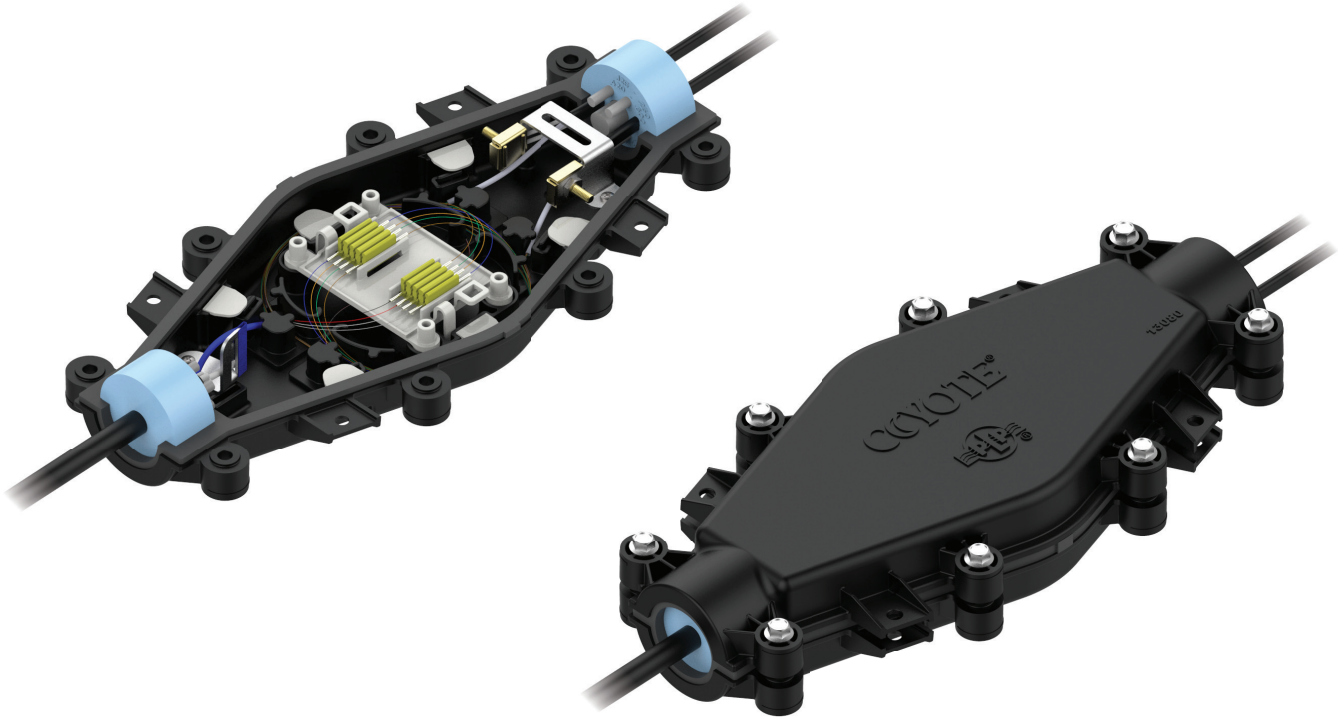

## COYOTE<sup>®</sup> LCC

The **COYOTE LCC (Low Count Closure)** is a compact closure that utilizes the COYOTE silicone grommet system and LITE-GRIP<sup>®</sup> splice platform, is designed making this rugged closure the ideal economical solution for new drop cable installations and critical repair situations.

### FEATURES AND BENEFITS

- Offers a cost-effective solution for quick restoration of damaged or cut fiber service drops
- Utilizes the LITE-GRIP splice block system which permits single fusion, mass fusion, mechanical, PLC splitters, or a combination of all within one closure
- Factory installed gasket allows for re-entry and re-use
- LCC halves are constructed of a UV-stabilized material
- Flexible grommet sealing technology supports a wide range of flat and round cable profiles
- Flat shape allows for mounting in small areas
- Flame-retardant and ribbon kits available
- Designed and tested in accordance with Telcordia<sup>®</sup> GR-771-CORE Buried, Underground, IP-68 Rated Requirements

## Specifications

Catalog Number	COYLCC-F001 through COYLCC-F015
Splice Capacity (Maximum) – Single Fusion, Mass Fusion	24, 72
Cable Ports <sup>1</sup>	2
Cable Diameters	0.093" – 1.00" (2.4 – 25.4 mm) and Flat Drop
Configuration	In-Line or Butt
Application	Direct Bury, Below Grade, Pole/Wall, Aerial
Ingress Protection	In accordance with Telcordia® GR-771-CORE, Buried, Underground, IP-68
Size	14.0" L x 6.5" W x 2.5" D (356 x 165 x 64 mm)

<sup>1</sup>Multi-hole grommets allow for more than one cable to enter each cable port.

## COYOTE LCC for Fiber Kit Contents

Catalog Number	Description
COYLCC-F001	COYOTE LCC Closure for Single Fusion – Includes (1) 7-Hole Grommet [1 Hole: 0.42" – 0.60" (10.7 – 15.2 mm) and 6 Holes: 0.125" – 0.250" (3.2 – 6.4 mm) and Flat Drop Cable] and (1) 12-Hole Grommet Flat Drop Cable
COYLCC-F002	COYOTE LCC Closure for Single Fusion – Includes: (1) 7-Hole Grommet [1 Hole: 0.42" – 0.60" (10.7 – 15.2 mm) and 6 Holes: 0.125" – 0.250" (3.2 – 6.4 mm) and Flat Drop Cable], (1) 12-Hole Grommet Flat Drop Cable, and (1) Bobbin Kit
COYLCC-F004	COYOTE LCC Closure for Single Fusion – Includes (2) 7-Hole Grommets [1 Hole: 0.42" – 0.60" (10.7 – 15.2 mm) and 6 Holes: 0.125" – 0.250" (3.2 – 6.4 mm) and Flat Drop Cable]
COYLCC-F005	COYOTE LCC Closure for Single Fusion – Includes (2) 2-Hole Grommets 0.42" – 0.60" (10.7 – 15.2 mm)
COYLCC-F006	COYOTE LCC Closure for Single Fusion – Includes (2) 4-Hole Grommets 0.30" – 0.43" (7.6 – 10.9 mm)
COYLCC-F008	COYOTE LCC Closure for Single Fusion – Includes (1) 1-Hole Grommet 0.40" – 0.60" (10.2 – 15.2 mm) and (1) 8-Hole Grommet 0.125" – 0.250" (3.2 – 6.4 mm) and Flat Drop Cable
COYLCC-F012	COYOTE LCC Closure for Single Fusion – Includes (2) 1-Hole Grommets 0.40" – 0.60" (10.2 – 15.2 mm)
COYLCC-F014	COYOTE LCC Closure for Single Fusion – Includes (2) 2-Hole Grommets 0.42" – 0.60" (10.7 – 15.2 mm) and (2) Dual Strength Member Brackets
COYLCC-F015	COYOTE LCC Closure for Single Fusion – Includes (2) 7-Hole Grommets [1 Hole: 0.42" – 0.60" (10.7 – 15.2 mm) and 6 Holes: 0.125" – 0.250" (3.2 – 6.4 mm) and Flat Drop Cable] and (2) Dual Strength Member Brackets

- For the COYOTE LCC Flame Retardant catalog numbers, insert "FR" into the catalog number code. Ex.: COYLCCFR-F001

- All kits include (1) LCC Closure, (2) Grommets, (3) LITE-GRIP® 8 CT. Single Fusion Splice Blocks, (1) Splice Platform, (1) Dual Strength Member Bracket, (1) L-Strength Member Bracket, (4) Fiber Management Clips

## COYOTE LCC Accessories

Catalog Number	Description
80808633	Flat Drop Cable Retention Bobbin Kit
80811037	4-Port Cable Retention Bobbin Kit
80811036	6-Port Drop Cable Retention Bobbin Kit
80809851	Dual Strength Member Bracket Kit – Includes (1) Dual Strength Member Bracket and (2) Cap/Stud Assemblies
8003843	L-Strength Member Bracket Kit – Includes (2) L-Strength Member Brackets
8003832	Aerial Mounting Bracket - Strand Applications
8003852	Aerial Mounting Bracket - ADSS Applications
8003830	Pole/Wall Mounting Bracket
8003835	Handhole Mounting Bracket

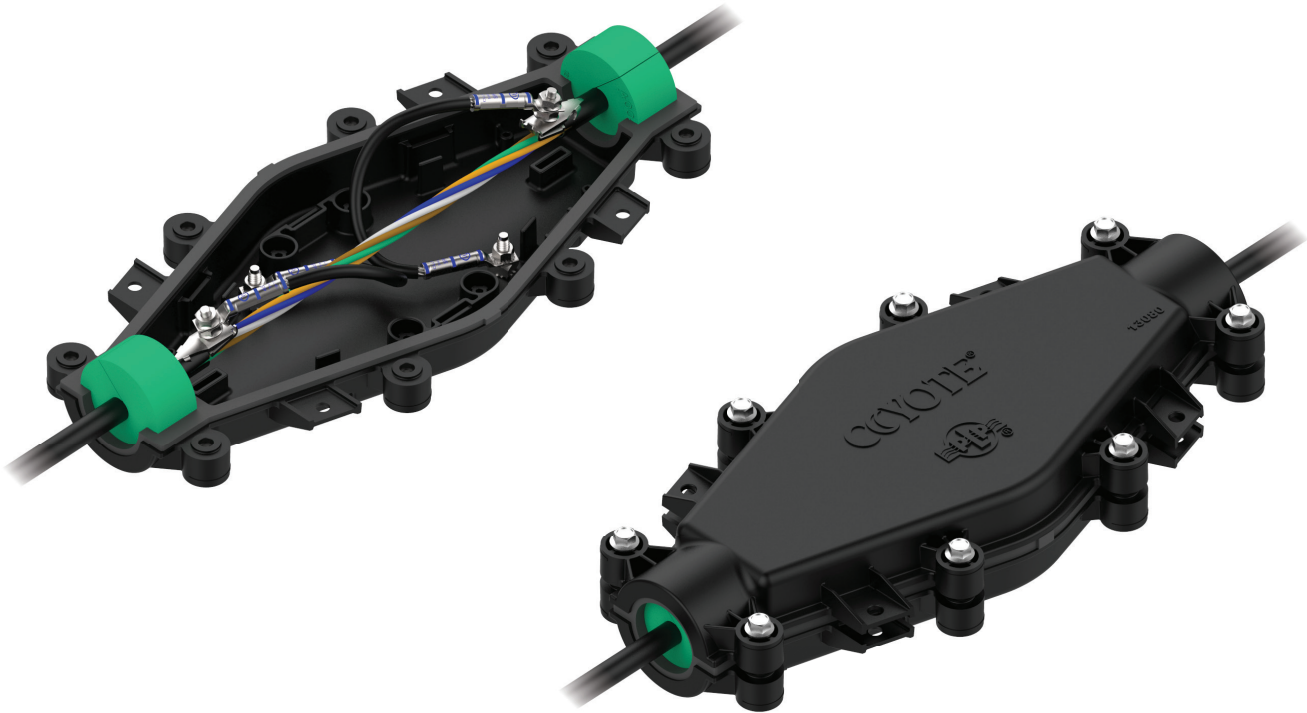

## COYOTE® BGC

The **COYOTE BGC (Bonding and Grounding Closure)** is a compact closure that utilizes the COYOTE silicone grommet system and integrated grounding studs, make this rugged closure the ideal economical solution for bonding and grounding needs.

### FEATURES AND BENEFITS

- Offers a cost-effective solution for bonding and grounding applications
- Two ground stud design provides the ability to trouble shoot without entering closure assembly
- Internal bonding leads with double crimped compression lugs designed to ensure a reliable bonding connection
- Factory installed gasket allows for re-entry and re-use
- BGC halves are constructed out of a rugged UV-stabilized material
- Flame-retardant kits available
- Factory slit, craft-friendly grommet system reduces assembly time
- Flat shape allows for mounting in small areas
- Captive hardware ensures quick, easy assembly, no special tools required
- Designed and tested in accordance with Telcordia® GR-771-CORE Buried, Underground, IP-68 Rated Requirements

## Specifications

<b>Catalog Number</b>	<b>COYBGC-001, COYBGC-002, COYBGC-003</b>
Cable Ports	2
Cable Diameters	0.40" – 0.96" (10.1 – 24.4 mm)
Ground Studs	2
Configuration	In-Line
Application	Direct Bury, Below Grade, Pole/Wall, Aerial
Ingress Protection	In accordance with Telcordia® GR-771-CORE, Buried, Underground, IP-68
Size	14.0" L x 6.5" W x 2.5" D (356 x 165 x 64 mm)

## COYOTE BGC Kit Contents for OSP Applications

Catalog Number	Description
COYBGC-001	COYOTE BGC Closure for Shielded Cable Diameters 0.40" – 0.60" (10.1 – 15.2 mm)
COYBGC-002	COYOTE BGC Closure for Shielded Cable Diameters 0.60" – 0.85" (15.2 – 21.6 mm)
COYBGC-003	COYOTE BGC Closure for Shielded Cable Diameters 0.85" – 0.96" (21.6 – 24.4 mm)

## COYOTE BGC Kit Contents for Vault Applications (Flame Retardant)

Catalog Number	Description
COYBGCFR-001	COYOTE BGC Closure for Shielded Cable Diameters 0.40" – 0.60" (10.1 – 15.2 mm)
COYBGCFR-002	COYOTE BGC Closure for Shielded Cable Diameters 0.60" – 0.85" (15.2 – 21.6 mm)
COYBGCFR-003	COYOTE BGC Closure for Shielded Cable Diameters 0.85" – 0.96" (21.6 – 24.4 mm)

All kits include (1) BGC Closure, (2) 1-Hole Grommets, and (2) Bond Connectors

## COYOTE BGC Accessories

Catalog Number	Description
8003832	Aerial Mounting Bracket - Strand Applications
8003830	Pole/Wall Mounting Bracket
8003835	Handhole Mounting Bracket

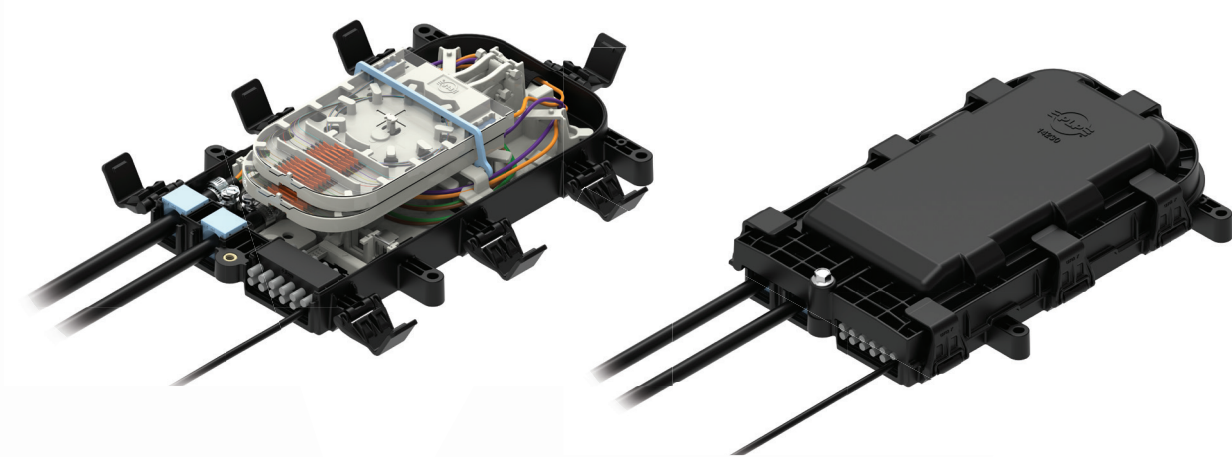

## COYOTE® STP-L

### STP PRO SERIES CLOSURE

Utilizing a similar design to PLP's original COYOTE STP Closure, the **STP-L** is a compact drop distribution closure that is designed to provide maximum adaptability to various splicing and connectivity applications. The STP-L easily accommodates unique splicing needs with interchangeable organizers supporting diverse connectivity requirements, multiple cover options, and a universal cable restraint system. The robust latch system, conical grommet design, and integrated over-molded cover enable quick re-entry that is designed to provide a secure seal over a wide range of cable profiles.

### FEATURES AND BENEFITS

- Single chamber design of the STP-L provides a compact solution for splice applications
- Integrated over-molded cover options are quickly assembled and removed from the closure
- Robust latch system and unique grommet design enable quick re-entry and re-use
- Universal cable restraint system works across the entire STP Pro platform
- Various base designs allow for a multitude of combinations of feed and drop cables in a compact design
- Conical grommet options support a wide range of cable diameters
- Constructed from a high-strength, UV-stabilized, flame-retardant material
- Designed and tested in accordance to Telcordia® GR-771-CORE Buried, Underground, IP-68 Rated Requirements

# COYOTE® STP-L

## Specifications

Catalog Number	STP-L3-48-001 through STP-L4-96-003
Cable Ports <sup>1</sup>	3 or 4
Cable Diameters	0.170" - 0.550" (4.3 - 14 mm), Round, Flat, and ROC™ Drop Cables
Configuration	Butt
Application	Direct Buried, Below Grade, Pole/Wall, and Aerial
Ingress Protection	In accordance to Telcordia® GR-771-CORE, Buried, Underground; IP-68
Size	11.8" L x 7.8" W x 2.4" H <sup>2</sup> (300 mm x 198 mm x 61 mm)

<sup>1</sup> Multi-hole grommets allow for more than one cable to enter each cable port.

<sup>2</sup> Outermost part of the assembly; using a shallow cover.

## COMPONENTS

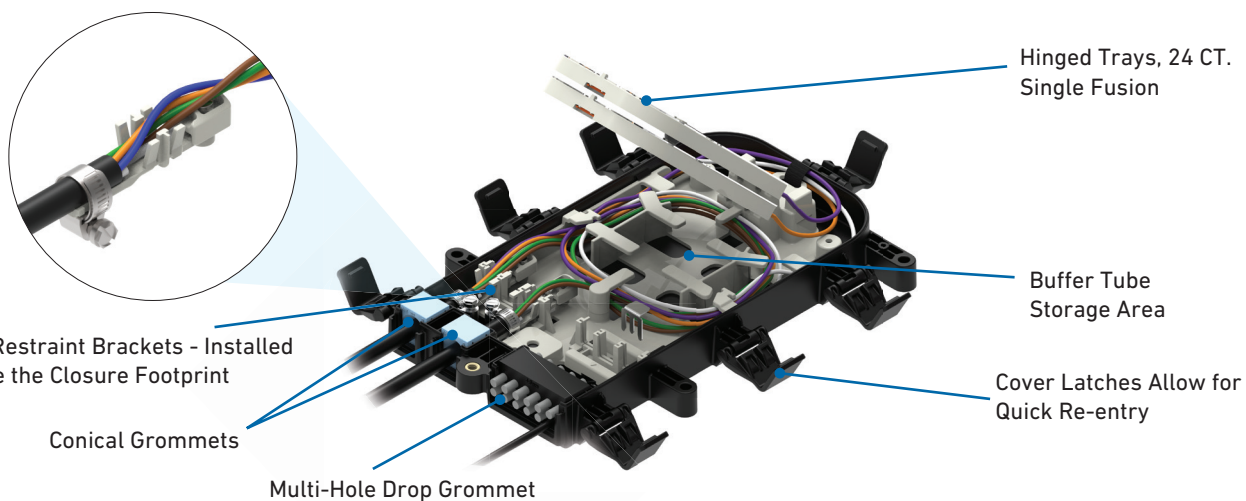

Universal Organizer STP-L

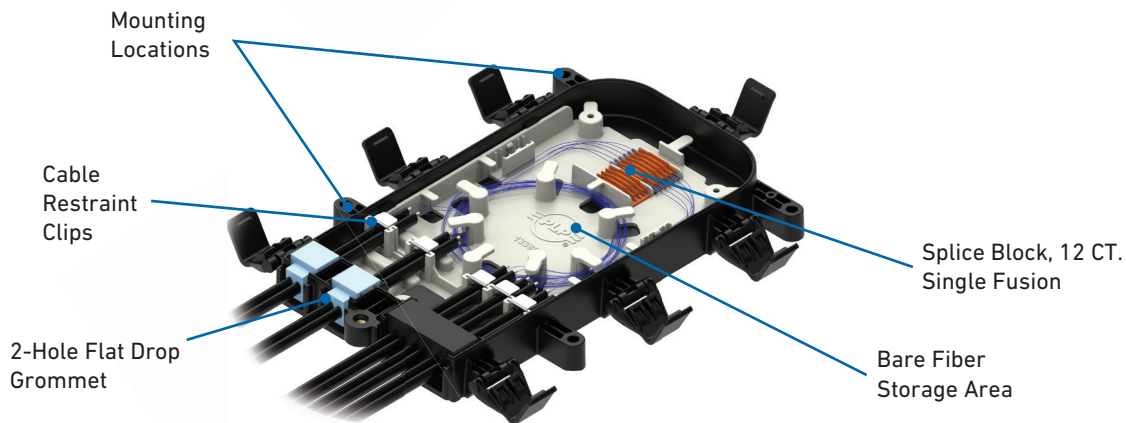

Drop Organizer STP-L

Contact PLP for more information



## COYOTE® STP-L CLOSURE KITS



### COYOTE STP-L 3-Port Base Closure Kits

Catalog Number	Description
STP-L3-48-001	COYOTE STP-L Closure with 3-Port Base – Includes (1) Shallow Cover, (2) Small Conical Grommets 0.17" - 0.40" (4.3 - 10.2 mm), (2) Large Conical Grommets 0.40" - 0.55" (10.2 - 14 mm), (1) 12-Hole Drop Grommet 0.193 - 0.201" (4.9 - 5.1 mm), and (2) 24 Ct. Splice Trays
STP-L3-48-002	COYOTE STP-L Closure with 3-Port Base – Includes (1) Shallow Cover, (2) Small Conical Grommets 0.17" - 0.40" (4.3 - 10.2 mm), (2) Large Conical Grommets 0.40" - 0.55" (10.2 - 14 mm), (1) 6-Hole Flat Drop Grommet, and (2) 24 Ct. Splice Trays
STP-L3-96-001	COYOTE STP-L Closure with 3-Port Base – Includes (1) Deep Cover, (2) Small Conical Grommets 0.17" - 0.40" (4.3 - 10.2 mm), (2) Large Conical Grommets 0.40" - 0.55" (10.2 - 14 mm), (1) 12-Hole Drop Grommet 0.193 - 0.201" (4.9 - 5.1 mm), and (4) 24 Ct. Splice Trays
STP-L3-96-002	COYOTE STP-L Closure with 3-Port Base – Includes (1) Deep Cover, (2) Small Conical Grommets 0.17" - 0.40" (4.3 - 10.2 mm), (2) Large Conical Grommets 0.40" - 0.55" (10.2 - 14 mm), (1) 6-Hole Flat Drop Grommet, and (4) 24 Ct. Splice Trays

All kits include (1) COYOTE STP-L 3-Port Base Assembly with Universal Organizer, (1) Cover, (2) Grommet Kits and Cable Restraint Hardware. Hanger Brackets are sold separately.

### COYOTE STP-L 4-Port Base Closure Kits

Catalog Number	Description
STP-L4-48-001	COYOTE STP-L Closure with 4-Port Base – Includes (1) Shallow Cover, (2) Small Conical Grommets 0.17" - 0.40" (4.3 - 10.2 mm), (2) Large Conical Grommets 0.40" - 0.55" (10.2 - 14 mm), and (2) 24 Ct. Splice Trays
STP-L4-48-002	COYOTE STP-L Closure with 4-Port Base – Includes (1) Shallow Cover, (2) Small Conical Grommets 0.17" - 0.40" (4.3 - 10.2 mm), (2) Large Conical Grommets 0.40" - 0.55" (10.2 - 14 mm), (2) 2-Hole Flat Drop Grommets, and (2) 24 Ct. Splice Trays
STP-L4-48-003	COYOTE STP-L Closure with 4-Port Base – Includes (1) Shallow Cover, (2) Small Conical Grommets 0.17" - 0.40" (4.3 - 10.2 mm), (2) Large Conical Grommets 0.40" - 0.55" (10.2 - 14 mm), (2) 2-Hole ROC™ Drop Grommets, and (2) 24 Ct. Splice Trays
STP-L4-96-001	COYOTE STP-L Closure with 4-Port Base – Includes (1) Deep Cover, (2) Small Conical Grommets 0.17" - 0.40" (4.3 - 10.2 mm), (2) Large Conical Grommets 0.40" - 0.55" (10.2 - 14 mm), and (4) 24 Ct. Splice Trays
STP-L4-96-002	COYOTE STP-L Closure with 4-Port Base – Includes (1) Deep Cover, (2) Small Conical Grommets 0.17" - 0.40" (4.3 - 10.2 mm), (2) Large Conical Grommets 0.40" - 0.55" (10.2 - 14 mm), (2) 2-Hole Flat Drop Grommets, and (4) 24 Ct. Splice Trays
STP-L4-96-003	COYOTE STP-L Closure with 4-Port Base – Includes (1) Deep Cover, (2) Small Conical Grommets 0.17" - 0.40" (4.3 - 10.2 mm), (2) Large Conical Grommets 0.40" - 0.55" (10.2 - 14 mm), (2) 2-Hole ROC Drop Grommets, and (4) 24 Ct. Splice Trays

All kits include (1) COYOTE STP-L 4-Port Base Assembly with Universal Organizer, (1) Cover, Grommet Kit(s) and Cable Restraint Hardware. Hanger Brackets are sold separately. ROC™ Drop Cables are for Dielectric Drop Cables ONLY.

## COYOTE® STP PRO SERIES ACCESSORIES AND MOUNTING BRACKETS

### Accessory Kits for COYOTE STP Pro Series

Catalog Number	Description
STPXL-TK-002	Splice Tray Kit – Includes (1) Splice Tray, (1) Cover, (2) 12 CT. Single Fusion Splice Blocks, (2) LITE-GRIP® Retention Sleeves for Microtube, (2) LITE-GRIP Retention Sleeves for Buffer Tubes, (2) LITE-GRIP Retention Sleeves for Micro Buffer Tubes, (1) Felt Strip, and (12) Cable Ties
STPXL-EK-001	Splice Tray Extension Kit – Includes (1) Deep Cover, and (1) Expansion Piece
80813747	Deep Cover Kit - Includes (1) Deep Cover and Silicone Lubricant
8004153	Splice Block Kit - Includes (6) 48 CT. Mass Fusion or Splitter Splice Blocks, Mustard
8004284	STP-L Bonding and Grounding Bracket

### Mounting Bracket Kits for COYOTE STP Pro Series

Catalog Number	Description
7400033	Aerial Mounting Bracket Kit – Strand Applications
8004214	Pole/Wall Mounting Bracket with Integrated Slack Storage <b>NOTE:</b> Can be used with (Catalog Number: 8004072E) SLACKLOOP 33" Cable Storage
8004248	Pole/Wall Mounting Bracket
80061735	Manhole Mounting Bracket

## FIBER SPLICING AND PATCHING

### Adapter Bulkhead

The adapter bulkhead can be installed on the drop organizer in the STP-L closures. This allows for flexibility in your network design while also providing a plug and play solution. Up to 24 SC or 48 LC connections can be installed using the cross-connect adapter bulkhead kits. The 24-Port Adapter Bulkhead requires the use of the Deep Cover. *Contact PLP for more information.*

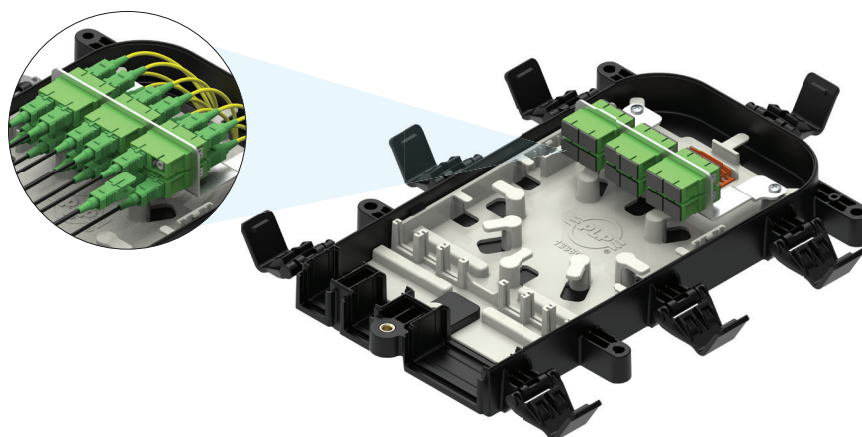

**STP-L3**  
with Standard Bulkhead and Adapters

*Contact PLP for more information*

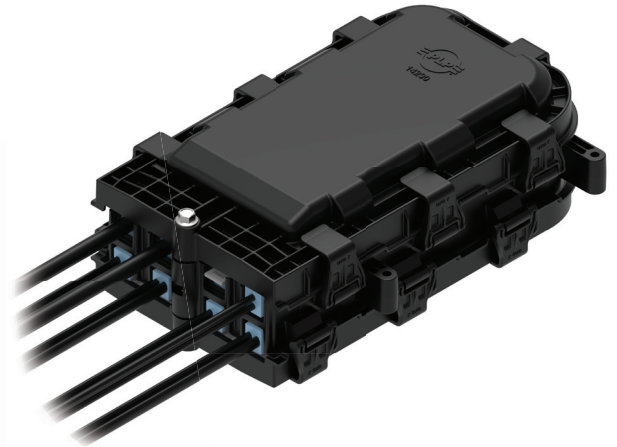
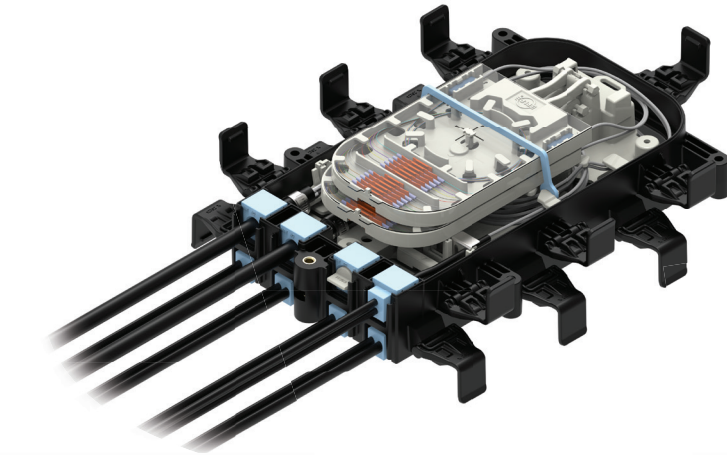

## COYOTE® STP-XL STP PRO SERIES CLOSURE

Utilizing a similar design to PLP's original COYOTE STP Closure, the **STP-XL** is a compact drop distribution closure that provides maximum adaptability to various splicing and connectivity applications. The STP-XL's dual chamber design easily accommodates unique splicing needs with interchangeable organizers to support diverse connectivity requirements, multiple cover options, and a universal cable restraint system. The robust latch system, conical grommet design, and integrated over-molded cover enable quick re-entry and provide a secure seal over a wide range of cable profiles.

### FEATURES AND BENEFITS

- Dual chamber design of the STP-XL provides independent access to both the splice/slack storage chamber and the drop connection chamber
- Integrated over-molded cover options are quickly interchangeable between the splice/slack storage chamber and the drop chamber to easily increase splice capacity
- Robust latch system and unique grommet design enable quick re-entry and re-use
- Universal cable restraint system works across the entire STP Pro platform
- Drop chamber design supports up to 24 drops (4.9 - 5.2 mm) or 8 flat or 8 ROC™ Drops.
- Conical grommet options support a wide range of cable diameters
- Constructed from a high-strength, UV-stabilized, flame-retardant material
- Designed and tested in accordance to Telcordia® GR-771-CORE Buried, Underground, IP-68 Rated Requirements

# COYOTE® STP-XL

## Specifications

Catalog Number	Description
Cable Ports <sup>1</sup>	6 or 8
Cable Diameters	0.170" - 0.550" (4.3 - 14 mm), Round, Flat, and ROC™ Drop Cables
Configuration	Butt
Application	Direct Buried, Below Grade, Pole/Wall, and Aerial
Ingress Protection	In accordance to Telcordia® GR-771-CORE, Buried, Underground; IP-68
Size	11.8" L x 7.8" W x 4.5" H (300 mm x 198 mm x 114 mm)

<sup>1</sup> Multi-hole grommets allow for more than one cable to enter each cable port. See grommet chart for more details. Outermost part of the assembly; using a shallow cover.

## COMPONENTS

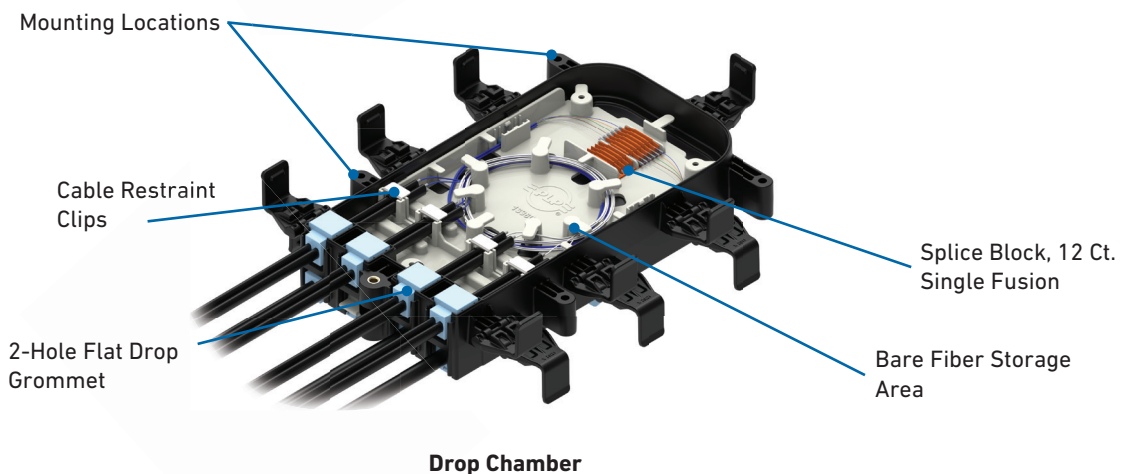
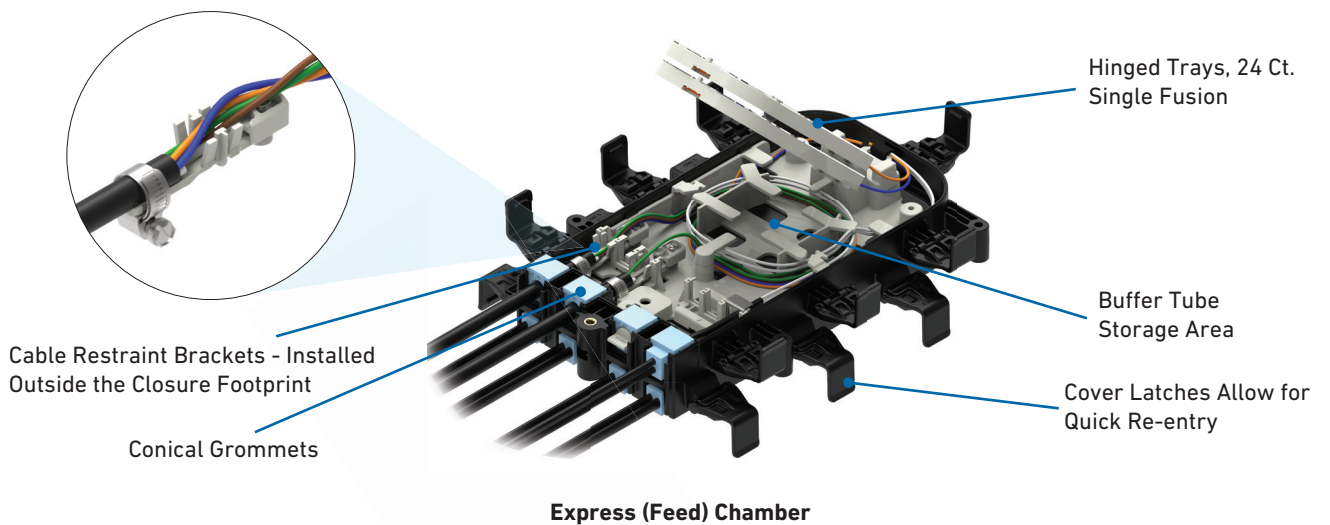

Telcordia® is a registered trademark of Telcordia Technologies, Inc., now part of Ericsson.  
ROC™ is a trademark of Corning Incorporated.



## COYOTE® STP-XL CLOSURE & ACCESSORY KITS

### COYOTE STP-XL 6-Port Base Closure Kits

Catalog Number	Description
STP-XL6-48-001	COYOTE STP-XL Closure with 6-Port Base – Includes (2) Shallow Covers, (4) Small Conical Grommets 0.17" - 0.40" (4.3 - 10.2 mm), (2) Large Conical Grommets 0.40" - 0.55" (10.2 - 14 mm), (2) 12-Hole Drop Grommets 0.193" - 0.205" (4.9 - 5.2 mm), and (2) 24 Ct. Splice Trays
STP-XL6-96-001	COYOTE STP-XL Closure with 6-Port Base – Includes (1) Shallow Cover, (1) Deep Cover, (4) Small Conical Grommets 0.17" - 0.40" (4.3 - 10.2 mm), (2) Large Conical Grommets 0.40" - 0.55" (10.2 - 14 mm), (2) 12-Hole Drop Grommets 0.193" - 0.205" (4.9 - 5.2 mm), and (4) 24 Ct. Splice Trays

All kits include (1) COYOTE STP-XL 6-Port Base Assembly with Universal Organizer and Drop Tray, (2) Covers, (8) Grommets and Cable Restraint Hardware. Hanger Brackets are sold separately.

### COYOTE STP-XL 8-Port Base Closure Kits

Catalog Number	Description
STP-XL8-48-002	COYOTE STP-XL Closure with 8-Port Base – Includes (2) Shallow Covers, (4) Small Conical Grommets 0.17" - 0.40" (4.3 - 10.2 mm), (2) Large Conical Grommets 0.40" - 0.55" (10.2 - 14 mm), (4) 2-Hole Flat Drop Grommets, and (2) 24 Ct. Splice Trays
STP-XL8-48-003	COYOTE STP-XL Closure with 8-Port Base – Includes (2) Shallow Covers, (4) Small Conical Grommets 0.17" - 0.40" (4.3 - 10.2 mm), (2) Large Conical Grommets 0.40" - 0.55" (10.2 - 14 mm), (4) 2-Hole ROC™ Drop Grommets, and (2) 24 Ct. Splice Trays
STP-XL8-96-002	COYOTE STP-XL Closure with 8-Port Base – Includes (1) Shallow Cover, (1) Deep Cover, (4) Small Conical Grommets 0.17" - 0.40" (4.3 - 10.2 mm), (2) Large Conical Grommets 0.40" - 0.55" (10.2 - 14 mm), (4) 2-Hole Flat Drop Grommets, and (4) 24 Ct. Splice Trays
STP-XL8-96-003	COYOTE STP-XL Closure with 8-Port Base – Includes (1) Shallow Cover, (1) Deep Cover, (4) Small Conical Grommets 0.17" - 0.40" (4.3 - 10.2 mm), (2) Large Conical Grommets 0.40" - 0.55" (10.2 - 14 mm), (4) 2-Hole ROC™ Drop Grommets, and (4) 24 Ct. Splice Trays

All kits include (1) COYOTE STP-XL 8-Port Base Assembly with Universal Organizer and Drop Tray, (2) Covers, (10) Grommets and Cable Restraint Hardware. Hanger Brackets are sold separately. ROC™ Drop Cables are for Dielectric Drop Cables ONLY.

### Accessory Kits for COYOTE STP Pro Series

Catalog Number	Description
STPXL-TK-002	Splice Tray Kit – Includes (1) Splice Tray, (1) Cover, (2) 12 Ct. Single Fusion Splice Blocks, (2) LITE-GRIP® Retention Sleeves for Microtube, (2) LITE-GRIP Retention Sleeves for Buffer Tubes, (2) LITE-GRIP Retention Sleeves for Micro Buffer Tubes, (1) Felt Strip, and (12) Cable Ties
80814576	Standard Cross-Connect Adapter Bulkhead – Empty. Used with flangeless adapters only. Supports up to 6 dual SC or quad LC adapters.
80814614	Deep Cross-Connect Adapter Bulkhead – Empty. Used with flangeless adapters only. Supports up to 12 dual SC or quad LC adapters. <b>NOTE:</b> Needs to be used in conjunction with a deep cover ( <b>Catalog Number: 80813747</b> ).
STPXL-EK-001	Splice Tray Extension Kit – Includes (1) Deep Cover, and (1) Expansion Piece
80813747	Deep Cover Kit - Includes (1) Deep Cover and Silicone Lubricant
8004153	Splice Block Kit - Includes (6) 48 CT. Mass Fusion or Splitter Splice Blocks, Mustard
80814575	Cover Tether Kit
8004285	STP-XL Bonding and Grounding Bracket

ROC™ is a trademark of Corning Incorporated.

## COYOTE® STP PRO SERIES ACCESSORIES & MOUNTING BRACKETS

### Cross-Connect Accessory Kits for COYOTE STP Pro Series

Catalog Number	Description
80813988	Flangeless Adapter Kit – Includes (6) SC/APC Duplex Flangeless Adapters
80813989	Flangeless Adapter Kit – Includes (6) SC/UPC Duplex Flangeless Adapters
80813990	Flangeless Adapter Kit – Includes (6) LC/APC Quad Flangeless Adapters
80813991	Flangeless Adapter Kit – Includes (6) LC/UPC Quad Flangeless Adapters
COYTRM-2PK-SCA-SB	Pigtail Kit – Includes (2) SC/APC 2 mm Jacketed Pigtails with Short Boot Connectors
COYTRM-2PK-SCU-SB	Pigtail Kit – Includes (2) SC/UPC 2 mm Jacketed Pigtails with Short Boot Connectors
COYTRM-3PK-SCA-SB	Pigtail Kit – Includes (3) SC/APC 2 mm Jacketed Pigtails with Short Boot Connectors
COYTRM-3PK-SCU-SB	Pigtail Kit – Includes (3) SC/UPC 2 mm Jacketed Pigtails with Short Boot Connectors
COYTRM-4PK-SCA-SB	Pigtail Kit – Includes (4) SC/APC 2 mm Jacketed Pigtails with Short Boot Connectors
COYTRM-4PK-SCU-SB	Pigtail Kit – Includes (4) SC/UPC 2 mm Jacketed Pigtails with Short Boot Connectors
COYTRM-4PK-LCA-SB	Pigtail Kit – Includes (4) LC/APC 2 mm Jacketed Pigtails with Short Boot Connectors
COYTRM-4PK-LCU-SB	Pigtail Kit – Includes (4) LC/UPC 2 mm Jacketed Pigtails with Short Boot Connectors
COYSP1X2SCA	COYOTE Pre-Connectorized Splitter - 1X2 SC/APC
COYSP1X4SCA	COYOTE Pre-Connectorized Splitter - 1X4 SC/APC
COYSP1X8SCA	COYOTE Pre-Connectorized Splitter - 1X8 SC/APC
COYSP1X16SCA	COYOTE Pre-Connectorized Splitter - 1X16 SC/APC

### Mounting Bracket Kits for COYOTE STP Pro Series

Catalog Number	Description
7400033	Aerial Mounting Bracket Kit – Strand Applications
8004214	Pole/Wall Mounting Bracket with Integrated Slack Storage <b>NOTE:</b> Can be used with (Catalog Number: 8004072E) SLACKLOOP 33" Cable Storage
8004248	Pole/Wall Mounting Bracket
80061735	Manhole Mounting Bracket

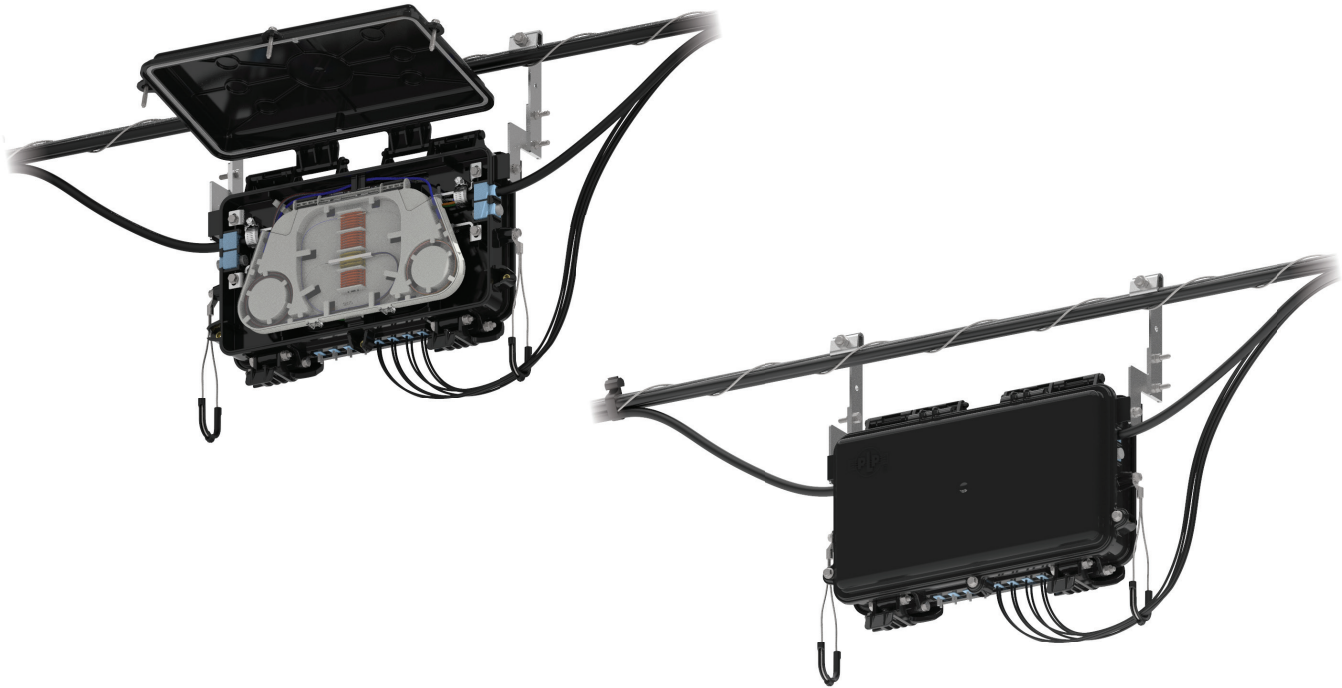

## COYOTE® ATC

The **COYOTE ATC (Aerial Terminal Closure)** is an aerial closure system designed to support the drop distribution network without the need for specialized drop cable assemblies. The closure features a unique dual chamber design with independent access to the splice/slack storage chamber and to the drop connection chamber. The cover latch system expedites access for drop installation and the fasteners secure the splice chamber cover to restrict access after initial installation. Inside the closure is a large slack storage area and splice tray system which supports single fusion, mass fusion, mechanical splice protectors, or splitter technology.

### FEATURES AND BENEFITS

- Dimensions: 17" x 10" x 4" (432 x 254 x 102 mm)
- Specially designed for aerial applications to provide superior performance in overhead installations
- Supports up to 48 single fusion splices, allowing for efficient fiber management
- Accommodates up to 16 Simplex SC or 16 Duplex LC adapters, ensuring versatile connectivity options
- Equipped with 4 splice chamber grommets and 8 drop chamber grommets, with multi-hole options available
- Splice chamber grommets accommodate cable diameters from 0.156" to 0.55" (4 - 14 mm), while drop chamber grommets accommodate diameters from 0.093" to 0.22" (2.4 - 5.6 mm), including flat drop and ROC™ drop cables
- Designed and tested in accordance to Telcordia® GR-771-CORE Above Grade, IP-55 Rated Requirements
- Constructed out of rugged UV-stabilized, flame retardant material (UL94-5VA Rated)
- Dual cover design allows independent access to each closure chamber

# ORDERING INFORMATION

## COYOTE® ATC Catalog Number

**ATC- XXXX - X - X - X - X - X**  
 (Section 1) (Section 2) (Section 3) (Section 4) (Section 5) (Section 6)  
 Must be in alphabetical order

Catalog Number Example: ATC-AADD-9-N-1-3-8

1

DROP CLOSURES

### Section 1

Splice Chamber Grommet Selection (Select 4)	Cable Diameter Range
A	SOLID / PLUG
B	0.200" – 0.250" (5.0 – 6.4 mm) ROUND CABLES
C	0.250" – 0.300" (6.4 – 7.6 mm) ROUND CABLES
D	0.300" – 0.350" (7.6 – 8.9 mm) ROUND CABLES
E	0.350" – 0.400" (8.9 – 10.2 mm) ROUND CABLES
F	0.400" – 0.450" (10.2 – 11.4 mm) ROUND CABLES
G	0.450" – 0.500" (11.4 – 12.7 mm) ROUND CABLES
H	0.500" – 0.550" (12.7 – 14.0 mm) ROUND CABLES
J	0.156" – 0.187" (4.0 – 4.7 mm) ROUND CABLES

### Section 2

Splice Chamber Splitter Type (Select 1)	
N	NONE
Bare Fiber PLC Splitters	
1	1x4
2	1x8
3	1x16
Pre-Connectorized PLC Splitters	
4	1x4 - SC/APC
5	1x4 - LC/APC
6	1x4 - SC/UPC
7	1x4 - LC/UPC
8	1x8 - SC/APC
9	1x8 - LC/APC
10	1x8 - SC/UPC
11	1x8 - LC/UPC
12	1x16 - SC/APC
13	1x16 - LC/APC
14	1x16 - SC/UPC
15	1x16 - LC/UPC

### Section 3

Splice Chamber Pigtails (Select 1) (Matches adapter type and quantity)	
N	NONE
Y	900 µm

### Section 4

Drop Chamber Grommet Selection (Select 1)	Cable Diameter Range
0	SOLID / PLUG
1	0.093" – 0.125" (2.4 – 3.2 mm) ROUND CABLES
2	0.156" – 0.170" (4.0 – 4.3 mm) ROUND CABLES
3	FOR FLAT DROP CABLES
4	0.187" – 0.220" (4.7 – 5.6 mm) ROUND CABLES
5	FOR ROC™ DROP CABLES (For Dielectric Drop Cables ONLY)

ROC™ is a trademark of Corning Incorporated.

### Section 5

Drop Chamber Adapter Type (Select 1)	
N	NONE
1	Simplex SC/APC
2	Simplex SC/UPC
3	Duplex LC/APC
4	Duplex LC/UPC

### Section 6

Drop Chamber Adapter Quantity
0 to 16

### Accessories

Catalog Number	Description
8004121	COYOTE ATC Aerial Mounting Bracket - ADSS Applications

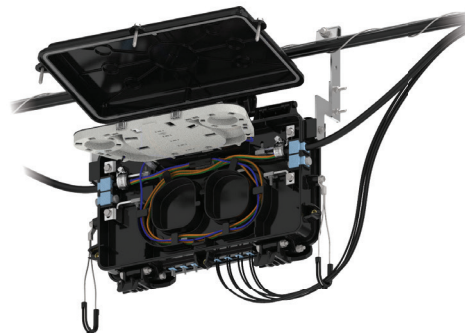

COYOTE ATC Splice Chamber

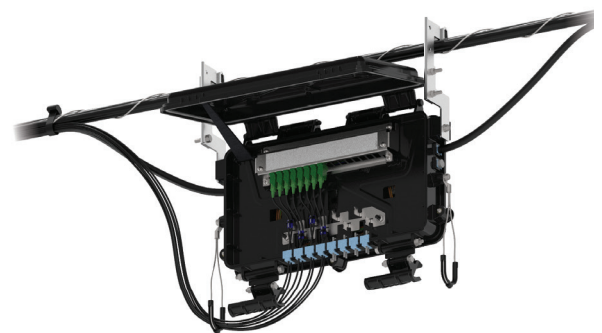

COYOTE ATC Drop Chamber

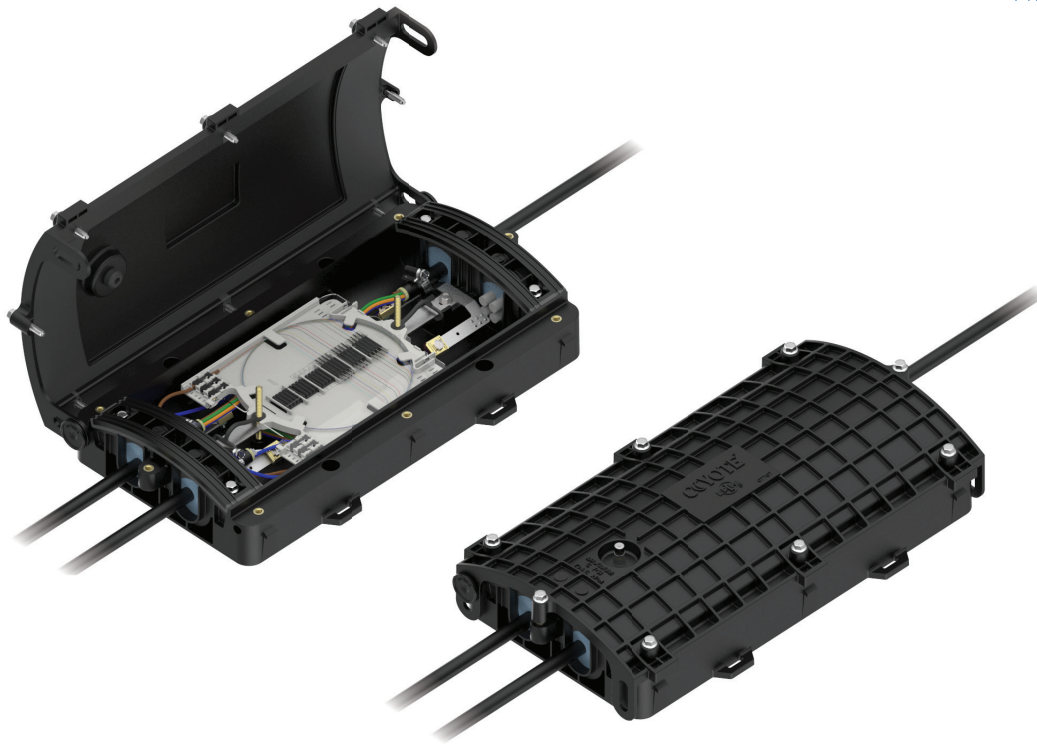

## COYOTE® IN-LINE RUNT CLOSURE

The **COYOTE In-Line Runt Closure** has the versatility to be used in both distribution and fiber-to-the-premise (FTTP) networks for in-line or butt applications. The compact size allows for placement in small handholes and pedestals.

### FEATURES AND BENEFITS

- Internal organizer manages buffer tube or ribbon
- Multiple splice tray designs support mass fusion splicing, single fusion splicing, or a combination of both
- Flexible grommet sealing technology supports a wide range of flat and round cable profiles
- Factory-installed gasket allows re-entry and re-use
- Flame-retardant kits available
- Designed and tested in accordance with Telcordia® GR-771-CORE Buried, Underground, IP-68 Rated Requirements

## Specifications

<b>Catalog Number</b>	<b>8006951, 8006952, 80061049</b>
Splice Capacity (Maximum) – Single Fusion (Low Profile, 80809958), Single Fusion (Low Profile, 80813152), Single Fusion (Deep Profile, 80808945), Mass Fusion (Deep Profile, LGSTR144)	96, 144, 80, 288
Number of Splice Trays – 80809958, 80813152, 80808945, LGSTR144	4, 4, 2, 2
Cable Ports <sup>1</sup>	4 (2 at each end)
Cable Diameters	0.093" – 1.20" (2.4 – 30.5 mm) and Flat Drop
Configuration	In-Line or Butt
Application	Direct Bury, Below Grade, Pole/Wall, Aerial only for 8006952, Indoor only for 80061049
Ingress Protection	In accordance with Telcordia® GR-771-CORE, Buried, Underground; IP-68
Size <sup>2</sup>	18.7" L x 10.0" W x 3.7" H (475 x 254 x 94 mm)

<sup>1</sup> Multi-hole grommets allow for more than one cable to enter each cable port

<sup>2</sup> Outermost part of the assembly.

## COYOTE In-Line RUNT Closure Kit Contents

Catalog Number	Description
8006951	In-Line RUNT Hermetically Sealed – Includes (2) 1-Hole Grommets 0.40" – 0.60" (10.2 – 15.2 mm), (1) 2-Hole Grommet 0.42" – 0.60" (10.7 – 15.2 mm), and (1) 4-Hole Grommet 0.30" – 0.43" (7.6 – 10.9 mm)
8006952	In-Line RUNT Free Breathing – Includes (2) 1-Hole Grommets 0.40" – 0.60" (10.2 – 15.2 mm), (1) 2-Hole Grommet 0.42" – 0.60" (10.7 – 15.2 mm), and (1) 4-Hole Grommet 0.30" – 0.43" (7.6 – 10.9 mm)
80061049	In-Line RUNT Flame Retardant, Hermetically Sealed – Includes (2) 1-Hole Grommets 0.40" – 0.60" (10.2 – 15.2 mm), (1) 2-Hole Grommet 0.42" – 0.60" (10.7 – 15.2 mm), (1) 4-Hole Grommet 0.30" – 0.43" (7.6 – 10.9 mm), (1) 6-Hole Grommet 0.125" - 0.250" (3.2 - 6.4 mm) and Flat Drop Cables, and a Torque Limiting Tool. For indoor use only.

All kits include (1) Closure Assembly, (4) Silicone Grommets and Cable Restraint Hardware (Splice Trays and Hanger Brackets Sold Separately)



Hermetically Sealed  
Catalog Number: 8006951



Free Breathing  
Catalog Number: 8006952



Flame Retardant, Hermetically Sealed  
Catalog Number: 80061049



## ACCESSORIES

Catalog Number	Description
80809958	Splice Tray, COYOTE LITE-GRIP® Short, Low Profile, 24 CT., Single Fusion
80813152	Splice Tray, COYOTE LITE-GRIP Short, Low Profile, 36 CT., Single Fusion
80808945	Splice Tray, COYOTE LITE-GRIP Short, Deep Profile, 40 CT., Single Fusion
LGSTR144	Splice Tray, COYOTE LITE-GRIP Short, Deep Profile, 144 CT., Mass Fusion
8004160	Heat Shrink Splice Protector Kit – Includes (50) 40 mm Mass Fusion
8004095	Heat Shrink Splice Protector Kit – Includes (50) 40 mm Single Fusion
8003717	Heat Shrink Splice Protector Kit – Includes (50) 60 mm Single Fusion
80811124	6 Position SC/APC Cross-Connect Bulkhead
80813787	6 Position ST/UPC Cross-Connect Bulkhead
80811123	8 Position SC/APC Cross-Connect Bulkhead
80811126	6 Position SC/UPC Cross-Connect Bulkhead
80811125	8 Position SC/UPC Cross-Connect Bulkhead
80809054	Cross-Connect Bulkhead
8003733	End Plate Kit – Includes (1) End Plate Cap with Integrated Gasket, (1) Package of Silicone Lubricant, and (3) Bolts
80807794	Hardware Bag
80805293	Transport Tube Kit – Includes (6) 0.135" (3.4 mm) ID x 34" (863 mm) Long Transport Tubes
80808639	Transport Tube Kit – Includes (3) 0.25" (6.3 mm) ID x 6' (1828 mm) Long Transport Tubes
8004180	6-Port Flat Drop Cable Retention Kit
8004181	8-Port Flat Drop Cable Retention Kit

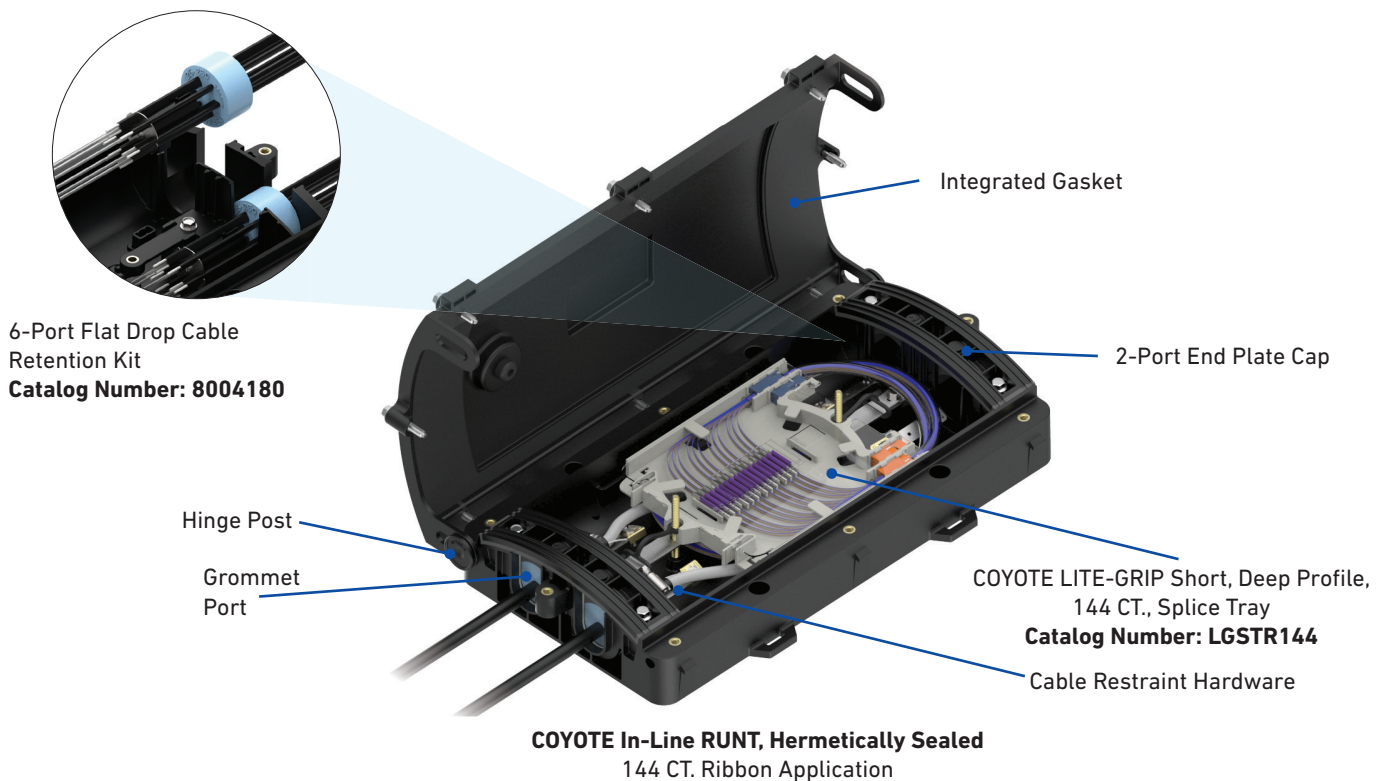

## MOUNTING BRACKETS

Catalog Number	Description
8003797	Aerial Mounting Bracket – Strand Applications
8004179	Horizontal Aerial Mounting Bracket – Strand Applications
8003864	Aerial Mounting Bracket – ADSS Applications
8003703	Pole/Wall Mounting Bracket
8003835	Universal Mounting Bracket – Handhole Applications
8003706	Swing Arm Mounting Bracket

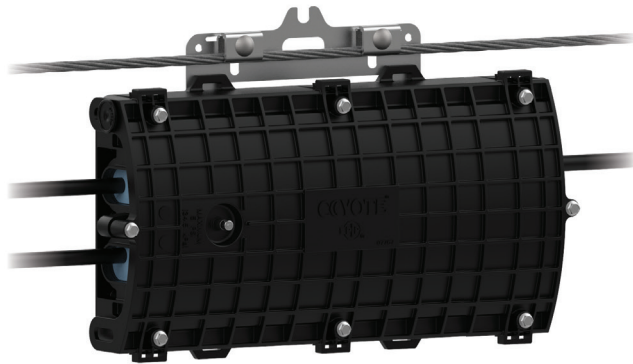

Aerial Mounting Bracket for Strand Application  
**Catalog Number: 8003797**



Horizontal Aerial Mounting Bracket for Strand Application  
**Catalog Number: 8004179**



Pole/Wall Mounting Bracket  
**Catalog Number: 8003703**

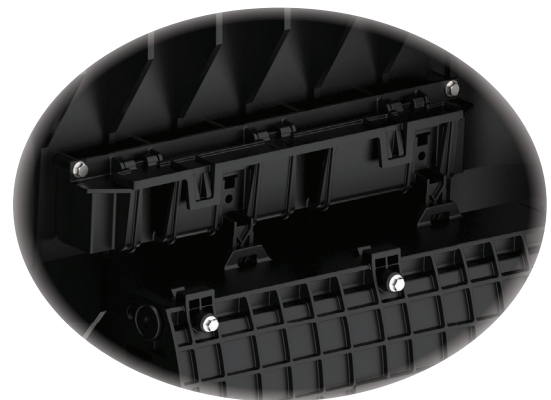

Universal Mounting Bracket  
**Catalog Number: 8003835**



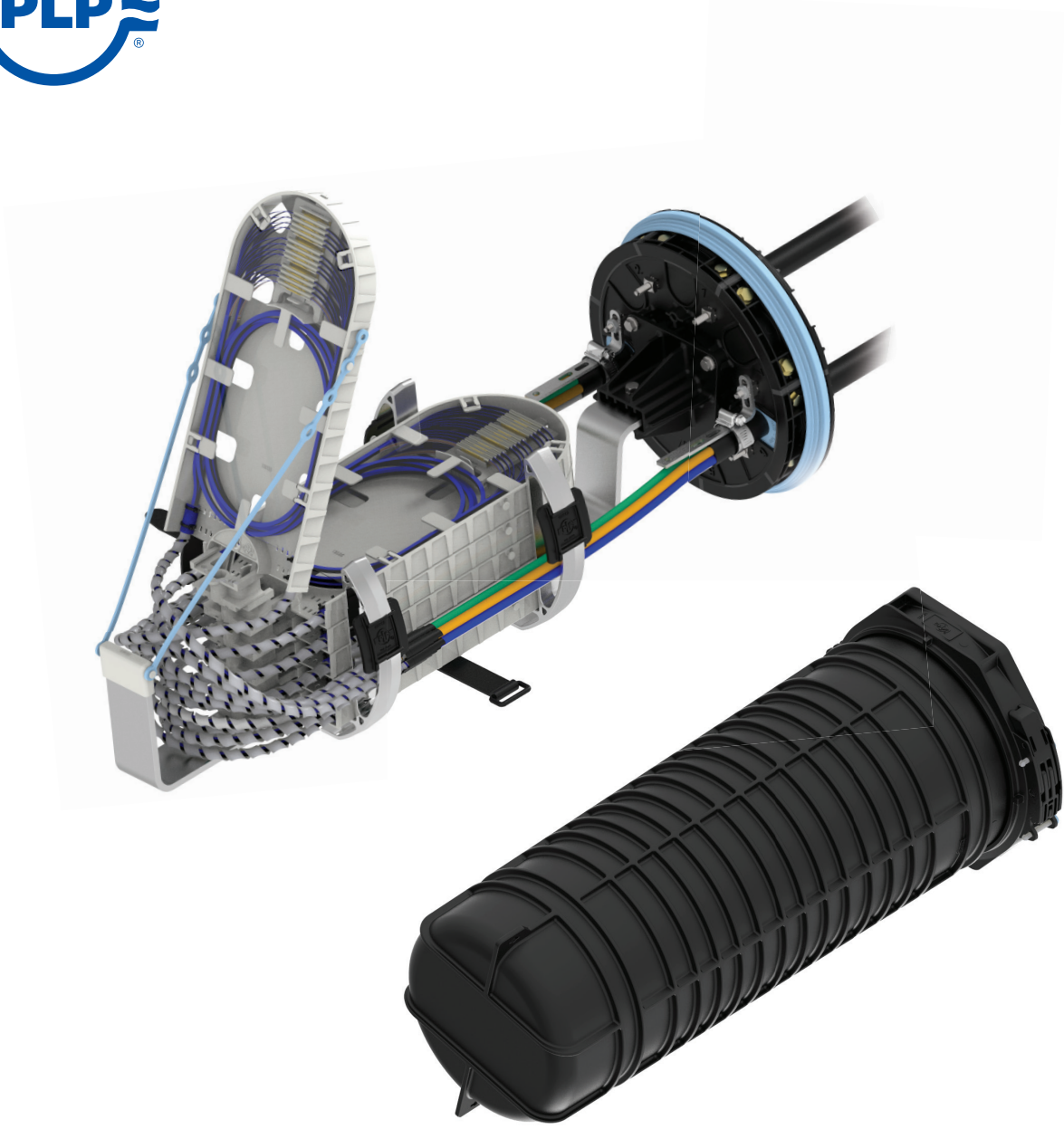

# SECTION 2 DOMES CLOSURES

COYOTE® FIBER OPTIC SOLUTIONS

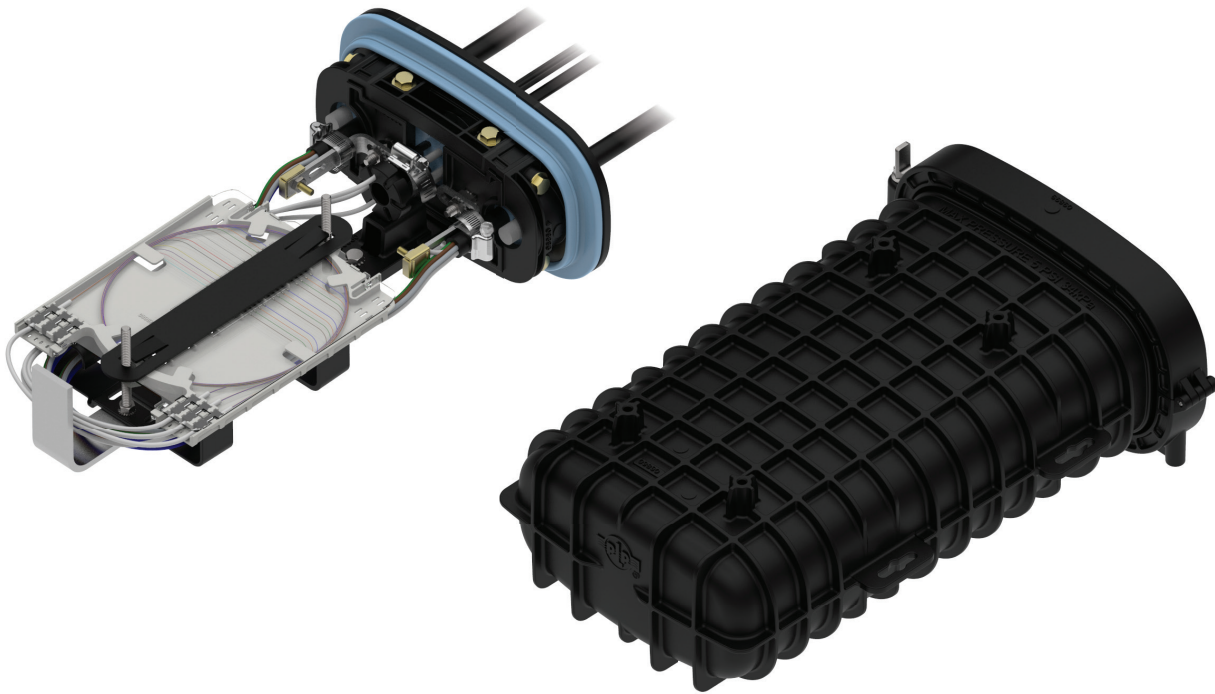

## COYOTE® ONE DOME CLOSURE

The **COYOTE ONE Dome Closure** has multiple organizer types to support either buffer tube or ribbon applications. These closures utilize PLP's patented segmented end plate design, which allows for independent access of each cable port without disturbing previously installed cables. This design also allows for ease of upgrading to a larger size without breaking the spliced joint, as your network continues to grow.

### FEATURES AND BENEFITS

- 3-Port segmented end plate design provides independent access to each cable port without disrupting the surrounding cables
- Tray design allows the removal from the stack to enable multiple splicers to work simultaneously
- Multiple splice tray designs support mass fusion splicing, single fusion splicing, or a combination of both
- Flexible grommet sealing technology supports a wide range of flat and round cable profiles
- Designed and tested in accordance with Telcordia® GR-771-CORE Buried, Underground, IP-68 Rated Requirements

# COYOTE ONE DOME CLOSURE

Specifications	Buffer	Ribbon	Universal
Catalog Number	COY1-001	COY1-002	COY1U-000
Splice Capacity (Maximum) – Single Fusion (Low Profile, 80809958), Single Fusion (Low Profile, 80813152), Single Fusion (Deep Profile, 80808945), Mass Fusion (Deep Profile, LGSTR144)	96, 144, 80, N/A	72, 108, 80, 288	96, 144, 80, 288
Number of Splice Trays – 80809958, 80813152, 80808945, LGSTR144	4, 4, 2, N/A	3, 3, 2, 2	4, 4, 2, 2
Cable Ports <sup>1</sup>	3		
Cable Diameters	0.093" – 0.85" (2.4 – 21.6 mm) and Flat Drop		
Ground Studs	3		
Configuration	Butt		
Application	Direct Bury, Below Grade, Pole/Wall, Aerial		
Ingress Protection	In accordance with Telcordia® GR-771-CORE, Buried, Underground; IP-68		
Size <sup>2</sup>	16.0" L x 10.8" W x 5.7" H (406 x 274 x 145 mm)		

<sup>1</sup> Multi-hole grommets allow for more than one cable to enter each cable port.

<sup>2</sup> Outermost part of the assembly; includes the sealing collar.

## ORGANIZER ASSEMBLIES

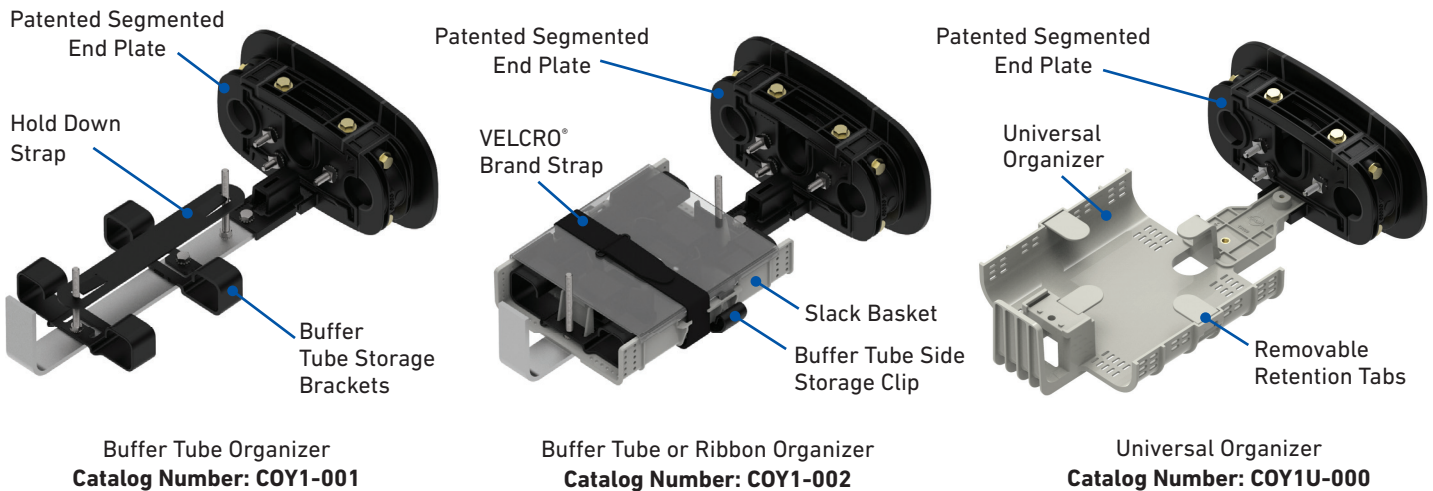

## COYOTE ONE Dome Closure Kit Contents

Catalog Number	Description
COY1-001	COYOTE ONE Dome Closure for Buffer Tube – Includes (2) 2-Hole Grommets 0.42" – 0.60" (10.7 – 15.2 mm), and (1) 6-Hole Grommet 0.125" – 0.250" (3.2 – 6.4 mm) and Flat Drop Cables
COY1-002	COYOTE ONE Dome Closure for Buffer Tube or Ribbon – Includes (2) 2-Hole Grommets 0.42" – 0.60" (10.7 – 15.2 mm), (1) 6-Hole Grommet 0.125" - 0.250" (3.2 - 6.4 mm) and Flat Drop Cables, and (1) Transition Tubing Kit
COY1U-000	COYOTE ONE Dome Closure with Universal Organizer - Includes (2) 2-Hole Grommets 0.42" - 0.60" (10.7 -15.2 mm), (1) 6-Hole Grommet 0.125" - 0.250" (3.2 - 6.4 mm) and Flat Drop Cables, and (1) Transition Tubing Kit

All kits include (1) COYOTE ONE End Plate with Organizer, (1) Dome, (1) Gasket, (1) Collar, (2) 2-Hole Grommets, (1) 6-Hole Grommet and Cable Restraint Hardware (Splice Trays and Hanger Brackets Sold Separately).

Telcordia® is a registered trademark of Telcordia Technologies, Inc., now part of Ericsson  
VELCRO® Brand is a registered trademark of Velcro BVBA.

## ACCESSORIES

### COYOTE ONE Dome Closure Accessories

Catalog Number	Description
80809958	Splice Tray, COYOTE LITE-GRIP® Short, Low Profile, 24 CT., Single Fusion
80813152	Splice Tray, COYOTE LITE-GRIP Short, Low Profile, 36 CT., Single Fusion
80808945	Splice Tray, COYOTE LITE-GRIP Short, Deep Profile, 40 CT., Single Fusion
LGSTR144	Splice Tray, COYOTE LITE-GRIP Short, Deep Profile, 144 CT., Mass Fusion
8004160	Heat Shrink Splice Protector Kit – Includes (50) 40 mm Mass Fusion
8004095	Heat Shrink Splice Protector Kit – Includes (50) 40 mm Single Fusion
8003717	Heat Shrink Splice Protector Kit – Includes (50) 60 mm Single Fusion
80810072	Cross-Connect Bulkhead
80809205	Strength Member Bracket Kit – Includes (2) Short L-Brackets
80811037	4-Port Cable Retention Bobbin Kit
80811036	6-Port Drop Cable Retention Bobbin Kit
80812928	6/8-Port Drop Cable Retention Bobbin Kit

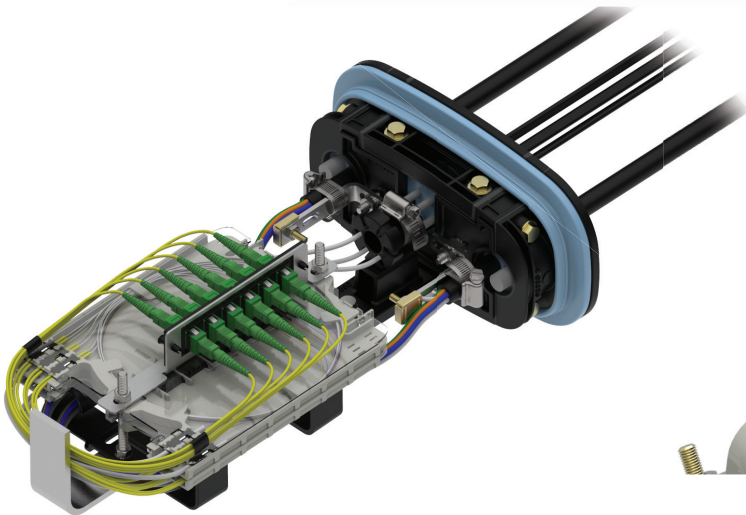

COYOTE ONE with Cross-Connect Bulkhead  
Catalog Number: 80810072

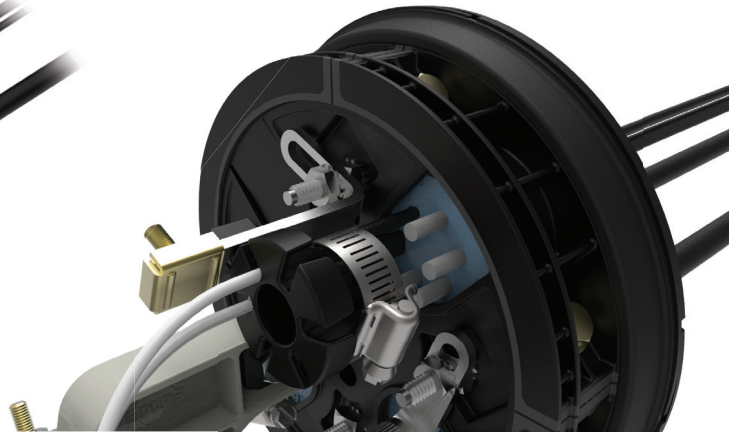

COYOTE 6.5"x17" with 6-Port Drop Cable Retention Bobbin  
Catalog Number: 80811036

# MOUNTING BRACKETS

## COYOTE ONE Dome Closure Mounting Brackets

Catalog Number	Description
EVOBKT-ALC	Aerial Low Clearance Mounting Bracket – Strand Applications
8004031	Aerial Low Clearance Mounting Bracket – ADSS Applications
EVOBKT-AE	Aerial Adjustable Offset Mounting Bracket – Strand Applications
8004032	Aerial Adjustable Offset Mounting Bracket – ADSS Applications
EVOBKT-PWM	Pole/Wall Mounting Bracket
8003835	Universal Mounting Bracket – Handhole Applications
8004003	Manhole Support Bracket

# DIMENSIONS

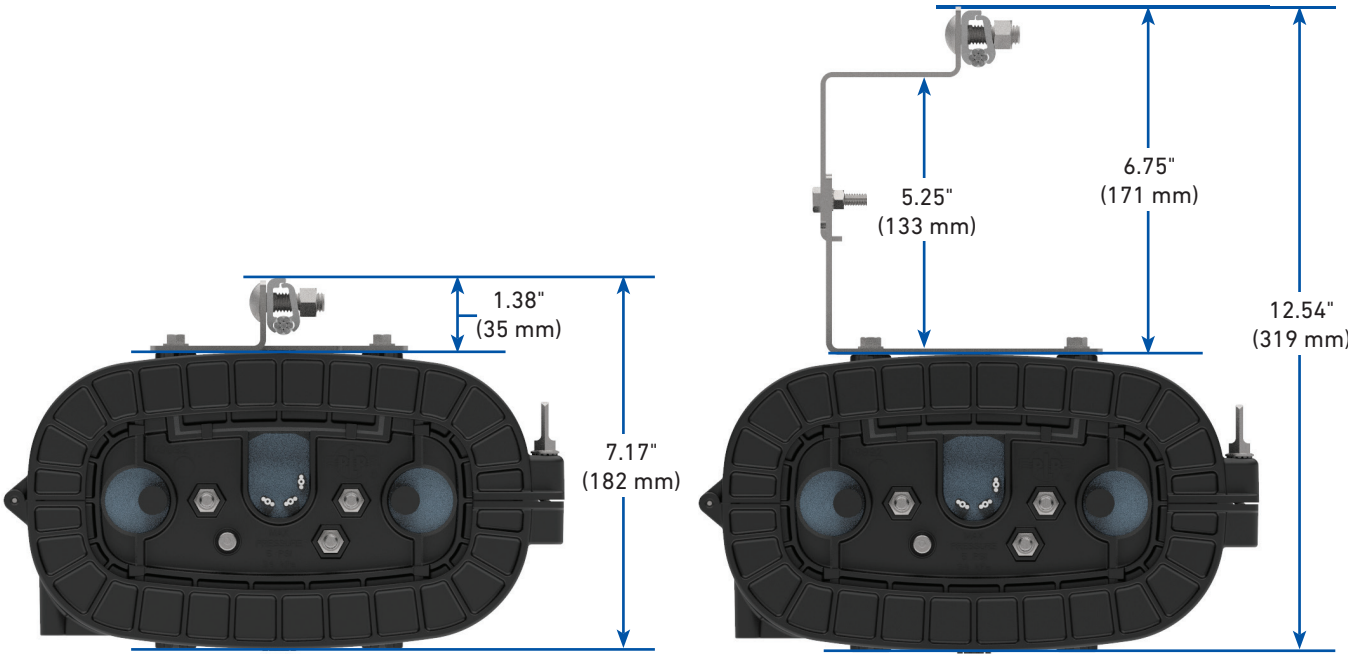

COYOTE ONE with Aerial Low Clearance Mounting Brackets for Strand Applications  
**Catalog Number: EVOBKT-ALC**

COYOTE ONE with Aerial Adjustable Offset Mounting Brackets for Strand Applications  
**Catalog Number: EVOBKT-AE**

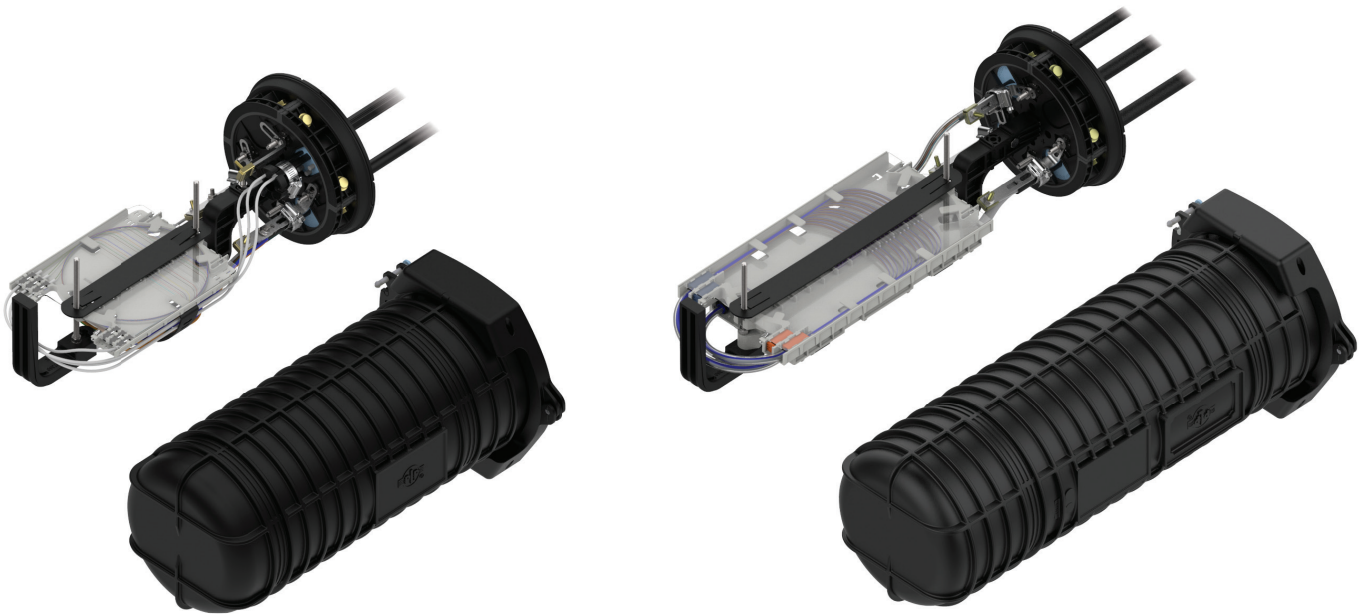

## COYOTE® DOME CLOSURE

6.5" X 17" AND 6.5" X 22"

The **COYOTE 6.5" Dome Closure** offers two length options of 17" and 22" to support either buffer tube or ribbon fiber applications. These closures utilize PLP's patented segmented end plate design, which allows for easy installation of a variety of cable sizes in conjunction with the grommets. This segmented end plate design also allows for ease of upgrading to a larger size if your network continues to grow.

### FEATURES AND BENEFITS

- 4-Port segmented end plate design provides independent access to each cable port without disrupting surrounding cables
- Tray design allows the removal from the stack to enable multiple splicers to work simultaneously
- Multiple tray designs support mass fusion splicing, single fusion splicing, or a combination of both
- Flexible grommet sealing technology supports a wide range of flat and round cable profiles
- Flame-retardant kits available
- Designed and tested in accordance with Telcordia® GR-771-CORE Buried, Underground, IP-68 Rated Requirements

# COYOTE® 6.5" X 17" DOME CLOSURE

Specifications	Buffer	Ribbon	Universal
<b>Catalog Numbers</b>	<b>8006944</b>	<b>8006945</b>	<b>COYD617U-000</b>
Splice Capacity (Maximum) – Single Fusion (Low Profile, 80809958), Single Fusion (Low Profile, 80813152), Single Fusion (Deep Profile, 80808945), Mass Fusion (Deep Profile, LGSTR144)	144, 216, 120, N/A	144, 216, 120, 432	144, 216, 120, 432
Number of Splice Trays – 80809958, 80813152, 80808945, LGSTR144	6, 6, 3, N/A	6, 6, 3, 3	6, 6, 3, 3
Cable Ports <sup>1</sup>	4		
Cable Diameters	0.093" – 1.25" (2.4 – 31.8 mm) and Flat Drop		
Ground Studs	4		
Configuration	Butt		
Application	Direct Bury, Below Grade, Pole/Wall, Aerial		
Ingress Protection	In accordance with Telcordia® GR-771-CORE, Buried, Underground; IP-68		
Size <sup>2</sup>	8.6" W x 17.9" L (218 x 455 mm)		

<sup>1</sup> Multi-hole grommets allow for more than one cable to enter each cable port.

<sup>2</sup> Outermost part of the assembly; includes the sealing collar.

## ORGANIZER ASSEMBLIES

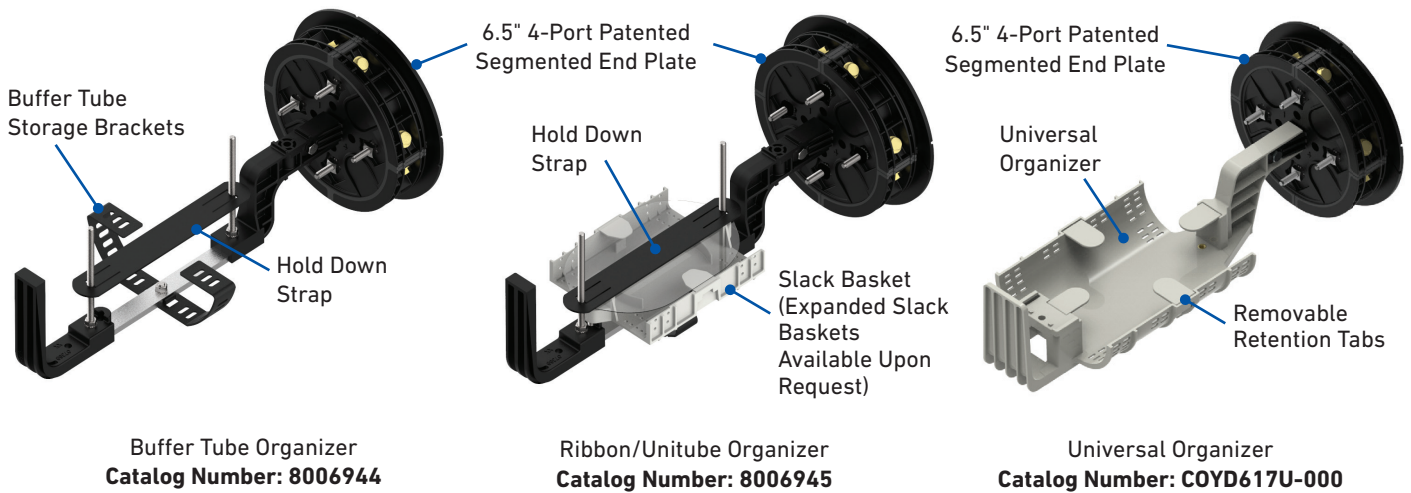

## COYOTE 6.5" x 17" Dome Closure Kit Contents

Catalog Number	Description
8006944	COYOTE 6.5" x 17" Dome Closure for Buffer Tube – Includes (2) 1-Hole Grommets 0.40" – 0.60" (10.2 – 15.2 mm) and (2) 1-Hole Grommets 0.60" – 0.85" (15.2 – 21.6 mm)
8006945	COYOTE 6.5" x 17" Dome Closure for Ribbon – Includes (2) 1-Hole Grommets 0.40" – 0.60" (10.2 – 15.2 mm), (2) 1-Hole Grommets 0.60" – 0.85" (15.2 – 21.6 mm), (1) Transition Tubing Kit, and (2) Transport Tubing Kits
COYD617U-000	COYOTE 6.5" x 17" Dome Closure with Universal Organizer – Includes (2) 1-Hole Grommets 0.40" – 0.60" (10.2 mm – 15.2 mm), (2) 1-Hole Grommets 0.60" – 0.85" (15.2 mm – 21.6 mm), and (1) Transition Tubing Kit

All kits include (1) COYOTE 6.5" End Plate with Organizer, (1) Dome, (1) Gasket, (1) Collar, (4) 1-Hole Grommets and Cable Restraint Hardware (Splice Trays and Hanger Brackets Sold Separately).



## COYOTE® 6.5" X 22" DOME CLOSURE

Specifications	Buffer	Ribbon	Universal
<b>Catalog Numbers</b>	<b>8006877</b>	<b>8006878</b>	<b>COYD622U-000</b>
Splice Capacity (Maximum) – Single Fusion (Standard Profile, 80810086), Single Fusion (Deep Profile, LGSTS72), Mass Fusion (Deep Profile, LGSTR216)	144, 216, N/A	144, 216, 648	144, 216, 648
Number of Splice Trays – 80810086, LGSTS72, LGSTR216	4, 3, N/A	4, 3, 3	4, 3, 3
Cable Ports <sup>1</sup>	4		
Cable Diameters	0.093" – 1.25" (2.4 – 31.8 mm) and Flat Drop		
Ground Studs	4		
Configuration	Butt		
Application	Direct Bury, Below Grade, Pole/Wall, Aerial		
Ingress Protection	In accordance with Telcordia® GR-771-CORE, Buried, Underground; IP-68		
Size <sup>2</sup>	8.6" W x 22.6" L (218 x 574 mm)		

<sup>1</sup> Multi-hole grommets allow for more than one cable to enter each cable port.

<sup>2</sup> Outermost part of the assembly; includes the sealing collar

## ORGANIZER ASSEMBLIES

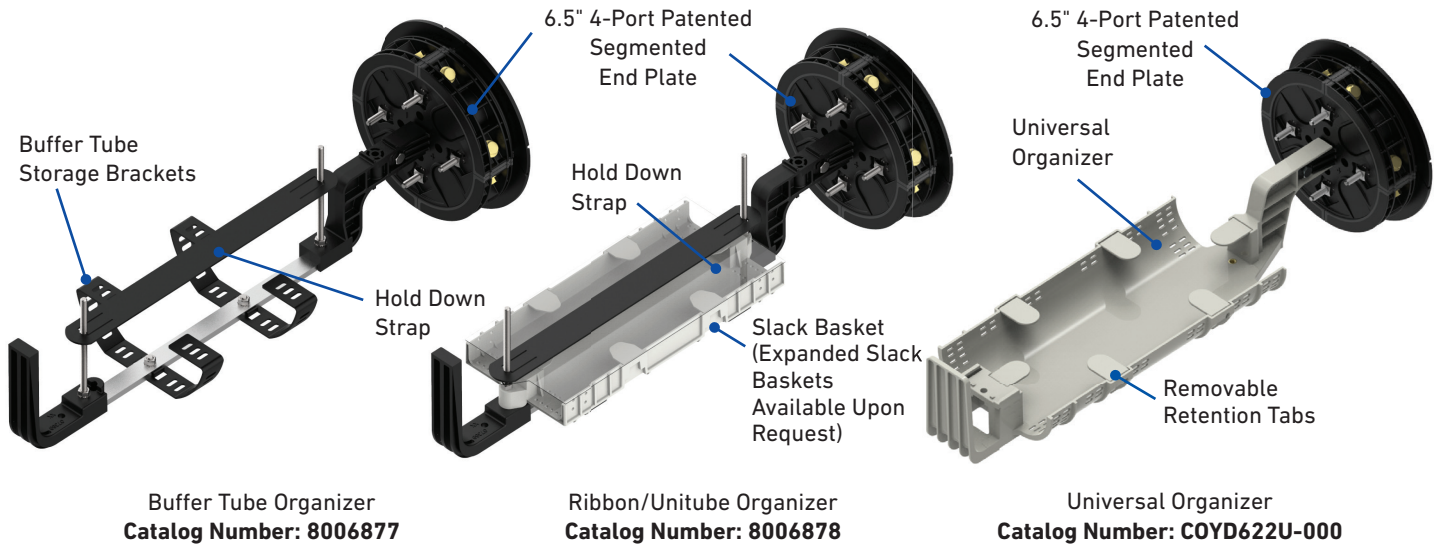

### COYOTE 6.5" x 22" Dome Closure Kit Contents

Catalog Number	Description
8006877	COYOTE 6.5" x 22" Dome Closure for Buffer Tube – Includes (2) 1-Hole Grommets 0.40" – 0.60" (10.2 – 15.2 mm), and (2) 1-Hole Grommets 0.60" – 0.85" (15.2 – 21.6 mm)
8006878	COYOTE 6.5" x 22" Dome Closure for Ribbon – Includes (2) 1-Hole Grommets 0.40" – 0.60" (10.2 – 15.2 mm), (2) 1-Hole Grommets 0.60" – 0.85" (15.2 – 21.6 mm), (1) Transition Tubing Kit, and (2) Transport Tubing Kits
COYD622U-000	COYOTE 6.5" x 22" Dome Closure with Universal Organizer – Includes (2) 1-Hole Grommets 0.40" – 0.60" (10.2 mm – 15.2 mm), (2) 1-Hole Grommets 0.60" – 0.85" (15.2 mm – 21.6 mm), and (1) Transition Tubing Kit

All kits include (1) COYOTE 6.5" End Plate with Organizer, (1) Dome, (1) Gasket, (1) Collar, (4) 1-Hole Grommets and Cable Restraint Hardware (Splice Trays and Hanger Brackets Sold Separately).

## ACCESSORIES AND MOUNTING BRACKETS

### COYOTE 6.5" Dome Closure Accessories

Catalog Number	Description
80809958	Splice Tray, COYOTE LITE-GRIP® Short, Low Profile, 24 CT., Single Fusion
80813152	Splice Tray, COYOTE LITE-GRIP Short, Low Profile, 36 CT., Single Fusion
80808945	Splice Tray, COYOTE LITE-GRIP Short, Deep Profile, 40 CT., Single Fusion
LGSTR144	Splice Tray, COYOTE LITE-GRIP Short, Deep Profile, 144 CT., Mass Fusion
80814649	Splice Tray, COYOTE LITE-GRIP® Short, Deep Profile 48 CT., . Single Fusion, 144 CT., Mass Fusion
80810086	Splice Tray, COYOTE LITE-GRIP Long, Standard Profile, 36 CT., Single Fusion
LGSTS72	Splice Tray, COYOTE LITE-GRIP Long, Deep Profile, 72 CT., Single Fusion
LGSTR216	Splice Tray, COYOTE LITE-GRIP Long, Deep Profile, 216 CT., Mass Fusion
80814650	Splice Tray, COYOTE LITE-GRIP® Long, Deep Profile 96 CT., . Single Fusion, 288 CT., Mass Fusion
8004160	Heat Shrink Splice Protector Kit – Includes (50) 40 mm Mass Fusion
8004095	Heat Shrink Splice Protector Kit – Includes (50) 40 mm Single Fusion
8003717	Heat Shrink Splice Protector Kit – Includes (50) 60 mm Single Fusion
COYEPFIX1	End Plate Assembly Fixture for 6.5" and 9.5" Domes
80808997	End Plate Gasket for 6.5" Domes
80807332	Latching Collar for 6.5" Domes
80061200	Breakaway Bonding Plate for 6.5" Domes
80809205	Strength Member Bracket Kit – Includes (2) Short L-Brackets
80808651	Strength Member Bracket Kit – Includes (4) Long L-Brackets
80808878	Large Strength Member Adapter Kit
80811037	4-Port Cable Retention Bobbin Kit
80811036	6-Port Drop Cable Retention Bobbin Kit
80812928	6/8-Port Drop Cable Retention Bobbin Kit

### COYOTE 6.5" Dome Closure Mounting Brackets

Catalog Number	Description
8003831	Aerial Mounting Bracket – Strand Applications
8004035	Aerial Adjustable Offset Mounting Bracket – Strand Applications
8003833	Aerial Mounting Bracket – ADSS Applications
8004036	Aerial Adjustable Offset Mounting Bracket – ADSS Applications
8003702	Pole/Wall Mounting Bracket
8003835	Universal Mounting Bracket – Handhole Applications
8003707	Swing Arm for Handhole Applications
8004003	Manhole Support Bracket

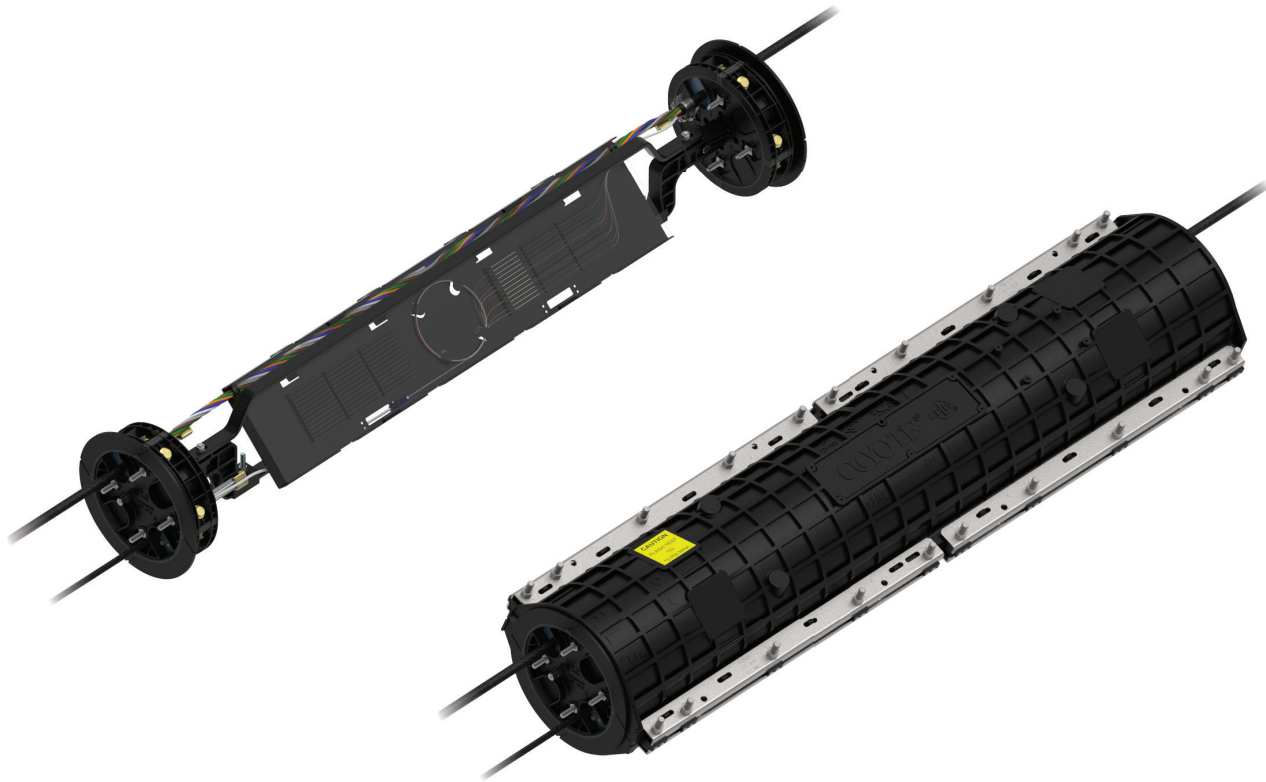

## COYOTE® TAUT CLOSURE

The **COYOTE Taut Closure** provides a protected access point for taut fiber optic cables where broken fibers need to be repaired or branching must occur. The unique organizer of the closure allows taut fibers to be safely secured and expressed through the closure while providing management and storage for those fibers being spliced. The closure uses the same patented segmented 6.5" end plates and grommet sealing system used in the 6.5" COYOTE Dome closures to allow for easy installation and dependable sealing around a variety of cable sizes. The gasketed rugged plastic shells and bolt bar system provide a reliable outer seal around the entire splice location.

### FEATURES AND BENEFITS

- Organizer permits taut fibers to be secured and expressed through the closure while providing the ability to break out broken/cut fibers for routing and splicing
- Central fiber management area of organizer stores and routes jumper fibers between repair splices of broken fibers or slack fibers from branch cables
- Factory installed splice blocks on organizer store up to 12 single fusion splices for each side of the cut location (24 total splices per closure)
- Staggered splice blocks allow for adjustability in placement of splices
- 4-Port segmented end plates provide independent access to each cable port without disrupting surrounding cables
- Flexible grommet sealing technology supports a wide range of flat and round cable profiles
- Durable plastic shells and bolt bar fastening system allow the closure to be re-entered and reused
- Aerial hanger brackets included with closure (strand and ADSS clamps sold separately)
- Designed and tested in accordance to Telcordia® GR-771-CORE Aerial, IP-67 Rated Requirements

## Specifications

<b>Catalog Number</b>	<b>8006947</b>
Splice Capacity (Maximum) - Single Fusion <sup>1</sup>	12 (one side) or 24 (both sides)
Cable Ports <sup>2</sup>	4 per side
Cable Diameters	0.093" – 1.25" (2.4 – 31.8 mm) and Flat Drop
Configuration	In-Line
Application	Aerial
Ingress Protection	In accordance with Telcordia® GR-771-CORE Aerial, IP-67
Size <sup>3</sup>	9.7" W x 39.1" L (246 x 993 mm)

<sup>1</sup> Splice capacity is based on whether one or both sides of the cut fibers from the main cable are being spliced.

<sup>2</sup> Multi-hole grommets allow for more than one cable to enter each cable port.

<sup>3</sup> Outermost part of the assembly; includes the bolt bar assemblies.

## COMPONENTS

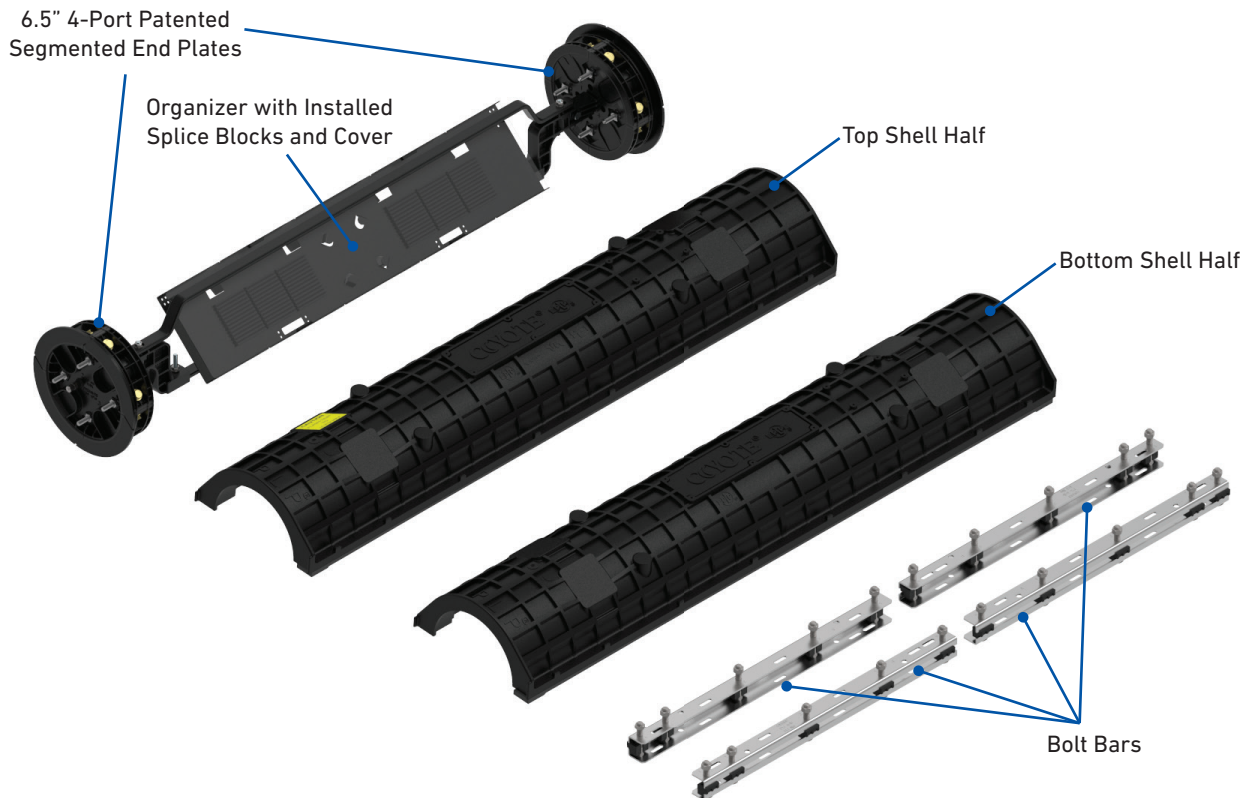

## COYOTE Taut Closure Kit Contents

Catalog Number	Description
8006947	COYOTE Taut Closure – Includes (2) 1-Hole Grommets 0.40" – 0.60" (10.2 – 15.2 mm) and (2) 1-Hole Grommets 0.60" – 0.85" (15.2 – 21.6 mm)

Kit includes (1) Organizer with COYOTE 6.5" End Plates, (1) Top Shell Half, (1) Bottom Shell Half, (1) Bolt Bar Set, (4) 1-Hole Grommets and Cable Restraint Hardware, (2) Ground Wire Assemblies, (1) Felt Strip, (1) 24 CT Bag of Tie Wraps, (1) Aerial Hanger Bracket Kit & Extended Aerial Hanger Bracket Kit (Strand and ADSS Clamps Not Included).

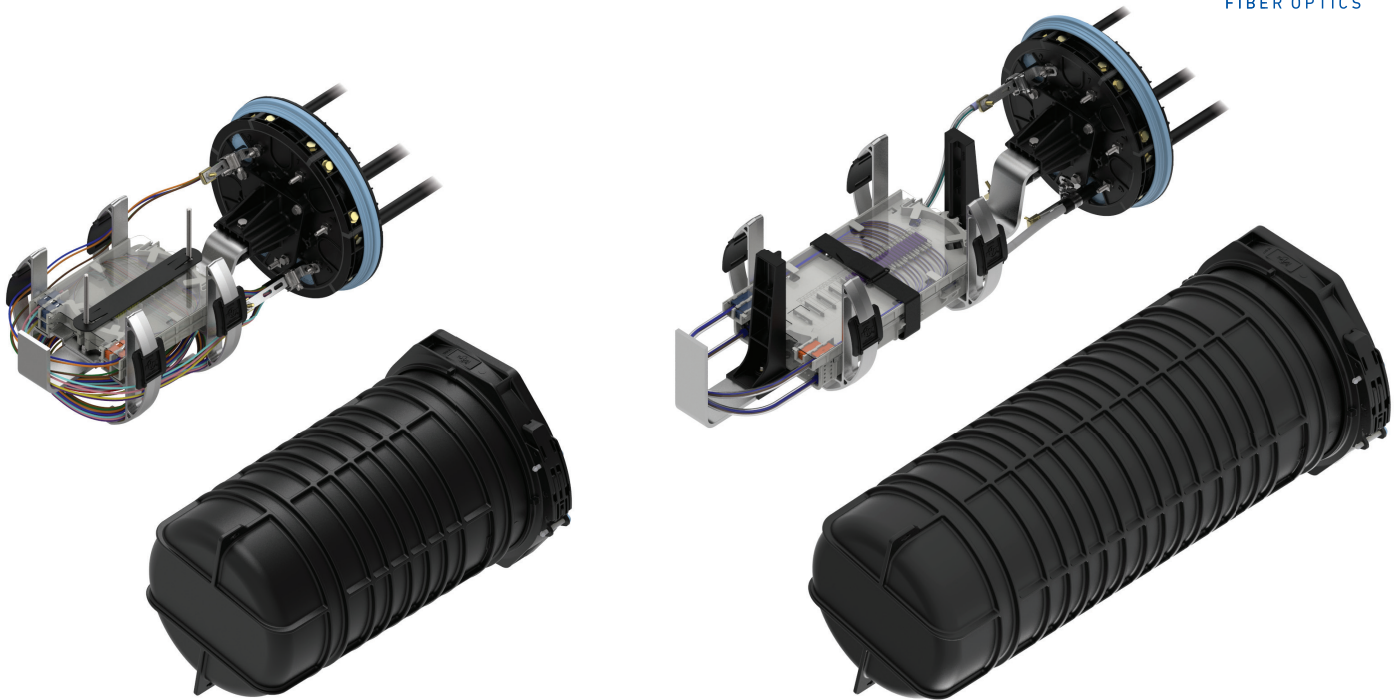

## COYOTE<sup>®</sup> DOME CLOSURE

9.5" X 19" AND 9.5" X 28"

The **COYOTE 9.5" Dome Closure** offers two length options of 19" and 28" to support either buffer tube or ribbon fiber applications. These closures utilize PLP's patented segmented end plate design, which allows for easy installation of a variety of cable sizes in conjunction with the grommets.

### FEATURES AND BENEFITS

- 7-Port segmented end plate design provides independent access to each cable port without disrupting surrounding cables
- Tray design allows the removal from the stack to enable multiple splicers to work simultaneously
- Multiple tray designs support mass fusion splicing, single fusion splicing, or a combination of both
- Flexible grommet sealing technology supports a wide range of flat and round cable profiles
- Designed and tested in accordance with Telcordia<sup>®</sup> GR-771-CORE Buried, Underground, IP-68 Rated Requirements

## COYOTE® 9.5" X 19" DOME CLOSURE

Specifications	Buffer	Ribbon	Universal
<b>Catalog Number</b>	<b>COYD919B-000</b>	<b>COYD919R-000</b>	<b>COYD919U-000</b>
Splice Capacity (Maximum) – Single Fusion (Low Profile, 80809958), Single Fusion (Low Profile, 80813152), Single Fusion (Deep Profile, 80808945), Mass Fusion (Deep Profile, LGSTR144)	288, 432, 240, N/A	288, 432, 240, 864	288, 432, 280, 1008
Number of Splice Trays – 80809958, 80813152, 80808945, LGSTR144	12, 12, 6, N/A	12, 12, 6, 6	12, 12, 7, 7
Cable Ports <sup>1</sup>	7		
Cable Diameters	0.093" – 1.25" (2.4 – 31.8 mm) and Flat Drop		
Ground Studs	7		
Configuration	Butt		
Application	Direct Bury, Below Grade, Pole/Wall, Aerial		
Ingress Protection	In accordance with Telcordia® GR-771-CORE, Buried, Underground; IP-68		
Size <sup>2</sup>	13.3" W x 20.4" L (338 x 509 mm)		

<sup>1</sup> Multi-hole grommets allow for more than one cable to enter each cable port.  
<sup>2</sup> Outermost part of the assembly; includes the sealing collar.

### ORGANIZER ASSEMBLIES

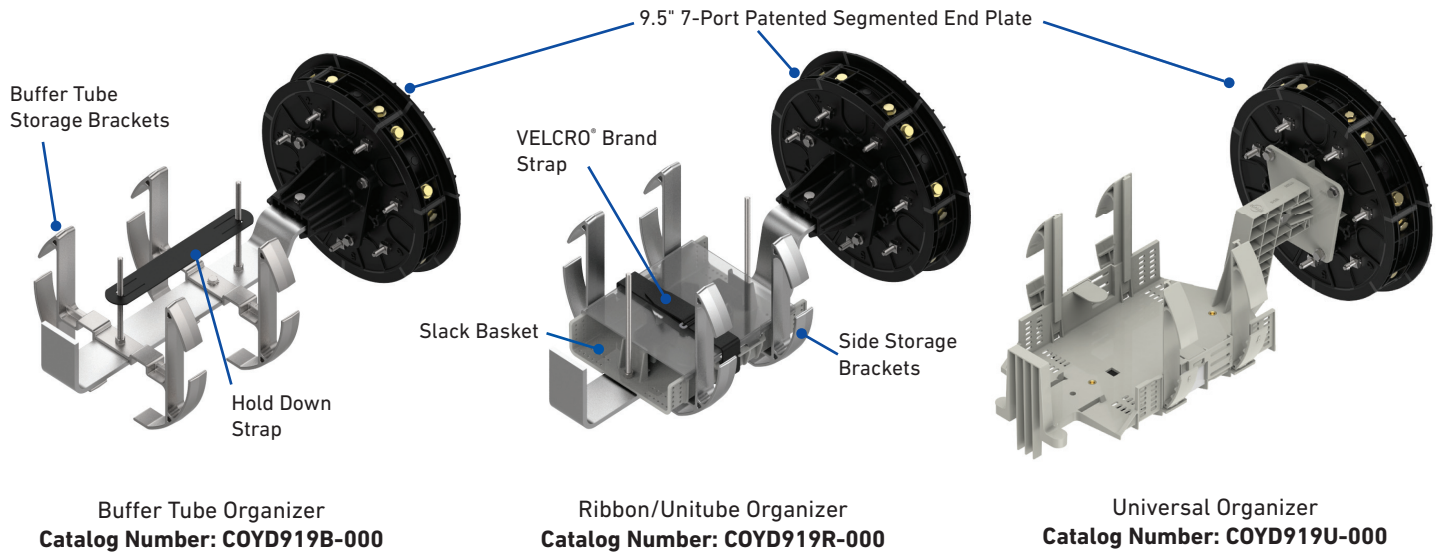

### COYOTE 9.5" x 19" Dome Closure Kit Contents

Catalog Number	Description
COYD919B-000	COYOTE 9.5" x 19" Dome Closure for Buffer Tube – Includes (2) 1-Hole Grommets 0.60" – 0.85" (15.2 – 21.6 mm) and (2) 1-Hole Grommets 0.85" – 1.00" (21.6 – 25.4 mm)
COYD919R-000	COYOTE 9.5" x 19" Dome Closure for Ribbon – Includes (2) 1-Hole Grommets 0.60" – 0.85" (15.2 – 21.6 mm), (2) 1-Hole Grommets 0.85" – 1.00" (21.6 – 25.4 mm), and (1) Transition Tubing Kit
COYD919U-000	COYOTE 9.5" x 19" Dome Closure with Universal Organizer – Includes (2) 1-Hole Grommets 0.60" – 0.85" (15.2 mm – 21.6 mm), (2) 1-Hole Grommets 0.85" – 1.00" (21.6 mm – 25.4 mm)

All kits include (1) COYOTE 9.5" End Plate with Organizer, (1) Dome, (1) Gasket, (1) Collar, (4) 1-Hole Grommets and Cable Restraint Hardware (Splice Trays and Hanger Brackets Sold Separately).

Telcordia® is a registered trademark of Telcordia Technologies, Inc., now part of Ericsson.  
 VELCRO® Brand is a registered trademark of Velcro BVBA.  
 CO-CA-1004-20



## COYOTE® 9.5" X 28" DOME CLOSURE

Specifications	Buffer	Ribbon	Max Tray	Universal
<b>Catalog Number</b>	<b>80061055</b>	<b>80061056</b>	<b>80061057</b>	<b>COYD928U-000</b>
Splice Capacity (Maximum) – Single Fusion (Standard Profile, 80810086), Single Fusion (Deep Profile, LGSTS72), Mass Fusion (Deep Profile, LGSTR216)	360, 432, N/A	396, 576, 1728	540, 720, 2160	396, 504, 1512
Number of Splice Trays – 80810086, LGSTS72, LGSTR216	10, 6, N/A	11, 8, 8	15, 10, 10	11, 7, 7
Cable Ports <sup>1</sup>	7			
Cable Diameters	0.093" – 1.25" (2.4 – 31.8 mm) and Flat Drop			
Ground Studs	7			
Configuration	Butt			
Application	Direct Bury, Below Grade, Pole/Wall, Aerial			
Ingress Protection	In accordance with Telcordia® GR-771-CORE, Buried, Underground; IP-68			
Size <sup>2</sup>	13.3" W x 29.4" L (338 x 749 mm)			

<sup>1</sup> Multi-hole grommets allow for more than one cable to enter each cable port.

<sup>2</sup> Outermost part of the assembly; includes the sealing collar.

## ORGANIZER ASSEMBLIES

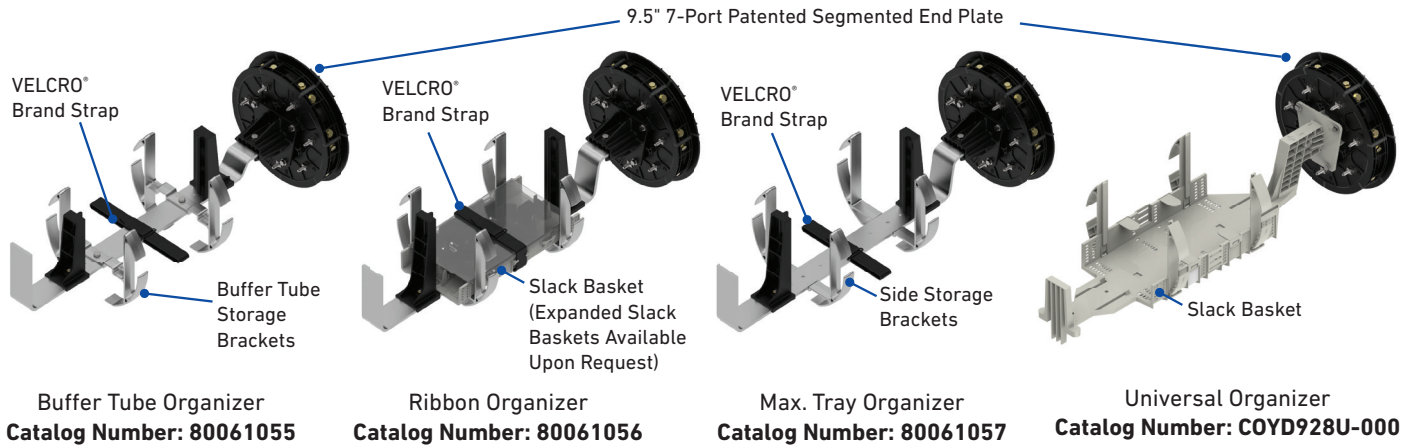

### COYOTE 9.5" x 28" Dome Closure Kit Contents

Catalog Number	Description
80061055	COYOTE 9.5" x 28" Dome Closure for Buffer Tube – Includes (2) 1-Hole Grommets 0.60" – 0.85" (15.2 – 21.6 mm) and (2) 1-Hole Grommets 0.85" – 1.00" (21.6 – 25.4 mm)
80061056	COYOTE 9.5" x 28" Dome Closure for Ribbon – Includes (2) 1-Hole Grommets 0.60" – 0.85" (15.2 – 21.6 mm), (2) 1-Hole Grommets 0.85" – 1.00" (21.6 – 25.4 mm), (2) Transition Tubing Kit, and (2) Transport Tubing Kits
80061057	COYOTE 9.5" x 28" Dome Closure for Buffer Tube – Includes and (2) 1-Hole Grommets 0.60" – 0.85" (15.2 – 21.6 mm) and (2) 1-Hole Grommets 0.85" – 1.00" (21.6 – 25.4 mm)
COYD928U-000	COYOTE 9.5" x 28" Dome Closure with Universal Organizer – Includes (2) 1-Hole Grommets 0.60" – 0.85" (15.2 mm – 21.6 mm), (2) 1-Hole Grommets 0.85" – 1.00" (21.6 mm – 25.4 mm)

All kits include (1) COYOTE 9.5" End Plate with Organizer, (1) Dome, (1) Gasket, (1) Collar, (4) 1-Hole Grommets and Cable Restraint Hardware (Splice Trays and Hanger Brackets Sold Separately).

## ACCESSORIES AND MOUNTING BRACKETS

### COYOTE 9.5" Dome Closure Accessories

Catalog Number	Description
80809958	Splice Tray, COYOTE LITE-GRIP® Short, Low Profile, 24 CT., Single Fusion
80813152	Splice Tray, COYOTE LITE-GRIP Short, Low Profile, 36 CT., Single Fusion
80808945	Splice Tray, COYOTE LITE-GRIP Short, Deep Profile, 40 CT., Single Fusion
LGSTR144	Splice Tray, COYOTE LITE-GRIP Short, Deep Profile, 144 CT., Mass Fusion
80814649	Splice Tray, COYOTE LITE-GRIP® Short, Deep Profile 48 CT., . Single Fusion, 144 CT., Mass Fusion
80810086	Splice Tray, COYOTE LITE-GRIP Long, Standard Profile, 36 CT., Single Fusion
LGSTS72	Splice Tray, COYOTE LITE-GRIP Long, Deep Profile, 72 CT., Single Fusion
LGSTR216	Splice Tray, COYOTE LITE-GRIP Long, Deep Profile, 216 CT., Mass Fusion
80814650	Splice Tray, COYOTE LITE-GRIP® Long, Deep Profile 96 CT., . Single Fusion, 288 CT., Mass Fusion
8004160	Heat Shrink Splice Protector Kit – Includes (50) 40 mm Mass Fusion
8004095	Heat Shrink Splice Protector Kit – Includes (50) 40 mm Single Fusion
8003717	Heat Shrink Splice Protector Kit – Includes (50) 60 mm Single Fusion
80061335	Deep Slack Basket (2.05" Deep) Kit for up to 576 Expressed Ribbon Applications
80061495	Deep Slack Basket (2.85" Deep) Kit for up to 864 Expressed Ribbon Applications
COYEPFIX1	End Plate Assembly Fixture for 6.5" and 9.5" Domes
80061477	Latching Collar and End Plate Gasket for 9.5" Domes
80061201	Breakaway Bonding Plate for 9.5" Domes
80809205	Strength Member Bracket Kit – Includes (2) Short L-Brackets
800015236	Strength Member Bracket Kit – Includes (3) Long L-Brackets and (3) Hose Clamps
80808651	Strength Member Bracket Kit – Includes (4) Long L-Brackets
80808878	Large Strength Member Adapter Kit
80811037	4-Port Cable Retention Bobbin Kit
80811036	6-Port Drop Cable Retention Bobbin Kit
80812928	6/8-Port Drop Cable Retention Bobbin Kit
80803989	Shield Connector

### COYOTE 9.5" Dome Closure Mounting Brackets Kits

Catalog Number	Description
8003940	Aerial Mounting Bracket – Strand Applications
8004037	Aerial Adjustable Offset Mounting Bracket – Strand Applications
8003869	Aerial Mounting Bracket – ADSS Applications
8004038	Aerial Adjustable Offset Mounting Bracket – ADSS Applications
8003942	Pole/Wall Mounting Bracket
8003835	Universal Mounting Bracket – Handhole Applications
8003941	Aerial Mounting Bracket – End Plate Mounting Applications
8004003	Manhole Support Bracket

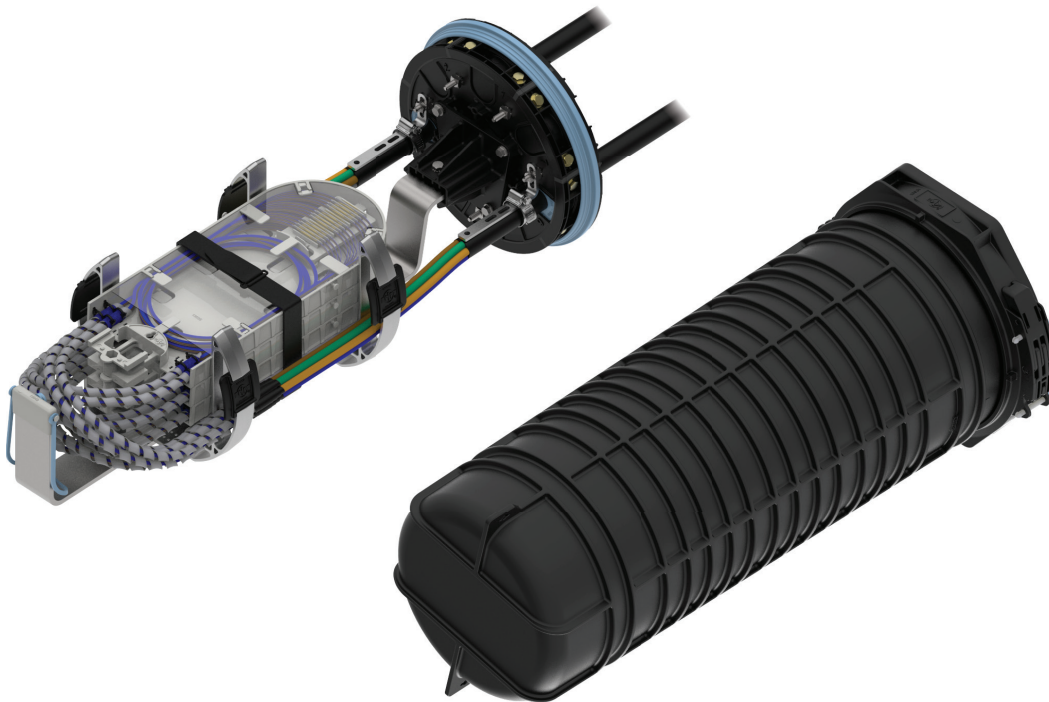

## COYOTE<sup>®</sup> HD DOME CLOSURE

The **COYOTE HD (High-Density) Dome Closure** offers an alternative fiber organizer to support high-density splice applications within the same footprint as PLP's existing 9.5" x 28" COYOTE Dome Closure. The new organizer architecture provides open access for fiber routing, reduces cable sheath openings, and simplifies assembly: all factors that save you time and money. When combined with PLP's patented segmented end plate design, the closure system offers the ultimate level of flexibility to address your complex network needs.

### FEATURES AND BENEFITS

- Maximum Splice Capacity of 1728 or 3456 depending on cable construction
- 7-Port segmented end plate design provides independent access to each cable port without disrupting surrounding cables
- Two splice tray designs to support mass fusion splicing, single fusion, or a combination of both
- Modular tray design permits trays to hinge upward or be removed from the stack to allow multiple splicers to work simultaneously
- Grommet range now accepts fiber optic cable entry of up to 1.38" in diameter
- Designed and tested in accordance with Telcordia<sup>®</sup> GR-771-CORE Buried, Underground, IP-68 Rated Requirement

## FOR CABLES UNDER 1.25" IN DIAMETER

Specifications	No Slack Basket	Standard Slack Basket	Deep Metal Slack Basket
<b>Catalog Number</b>	<b>80061406</b>	<b>80061407</b>	<b>80061594</b>
Splice Capacity (Maximum) – Single Fusion (Thin, 80813123), Mass Fusion (Thin, 80813122), Mass Fusion (Deep, 80813121), Mass Fusion (Deep, 80813779)	864, 3456 <sup>1</sup> , 1728, 3456	576, 2304 <sup>1</sup> , 1152, 2304	432, 1728 <sup>1</sup> , 864, 1728
Number of Splice Trays – 80813123, 80813122 <sup>1</sup> , 80813121, 80813779	12, 12, 6, 6	8, 8, 4, 4	6, 6, 3, 3
Cable Ports <sup>2</sup>	7		
Cable Diameters	0.093" – 1.25" (2.4 – 31.8 mm) and Flat Drop		
Ground Studs	7		
Configuration	Butt		
Application	Direct Bury, Below Grade, Pole/Wall, Aerial		
Ingress Protection	In accordance with Telcordia® GR-771-CORE, Buried, Underground; IP-68		
Size <sup>3</sup>	13.3" W x 29.4" L (338 x 747 mm)		

<sup>1</sup> The 80813122 thin-profile splice tray can only be used for cables that contain SpiderWeb Ribbon (SWR®) – AFL, Rollable Ribbon (RR) – OFS, Pliable Ribbon – Sumitomo, or FlexRibbon™ – Prysmian

<sup>2</sup> Multi-hole grommets allow for more than one cable to enter each cable port.

<sup>3</sup> Outermost part of the assembly.

## ORGANIZER ASSEMBLIES

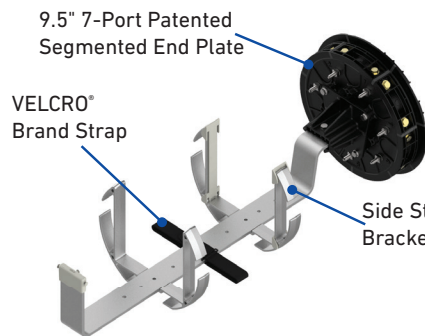

Ribbon Organizer – No Slack Basket  
Catalog Number: **80061406**

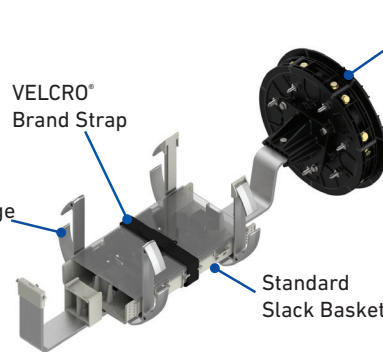

Ribbon Organizer – Standard Slack Basket  
Catalog Number: **80061407**

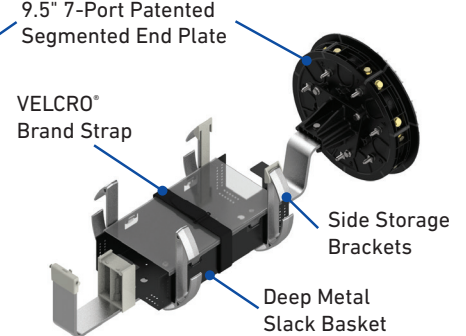

Ribbon Organizer – Deep Metal Slack Basket  
Catalog Number: **80061594**

## COYOTE HD Dome Closure Kit Contents

Catalog Number	Description
80061406	COYOTE HD Dome Closure for Ribbon – Includes (2) 1-Hole Grommets 0.85" – 1.00" (21.6 – 25.4 mm) and (2) 1-Hole Grommets 1.00" – 1.25" (25.4 – 31.8 mm)
80061407	COYOTE HD Dome Closure with Slack Basket for Ribbon – Includes (2) 1-Hole Grommets 0.85" – 1.00" (21.6 – 25.4 mm), (2) 1-Hole Grommets 1.00" – 1.25" (25.4 – 31.8 mm), and (1) 6-Pack, 36" long of 0.25" ID Transition Tubing
80061594	COYOTE HD Dome Closure with Deep Metal Slack Basket for Ribbon – Includes (2) 1-Hole Grommets 0.85" – 1.00" (21.6 – 25.4 mm), (2) 1-Hole Grommets 1.00" – 1.25" (25.4 – 31.8 mm), and (1) 6-Pack, 36" Long of 0.25" ID Transition Tubing

All kits include (1) COYOTE HD End Plate Organizer, (1) Dome, (1) Gasket, (1) Collar, (4) 1-Hole Grommets, (1) 12-Pack of 20" Long 0.50" ID Spiral Tubing, and Cable Restraint Hardware.



## FOR CABLES OVER 1.25" IN DIAMETER

Specifications	No Slack Basket	Standard Slack Basket
<b>Catalog Number</b>	<b>80061408</b>	<b>80061409</b>
Splice Capacity (Maximum) – Single Fusion (Thin, 80813123), Mass Fusion (Thin, 80813122), Mass Fusion (Deep, 80813121), Mass Fusion (Deep, 80813779)	864, 3456 <sup>1</sup> , 1728, 3456	576, 2304 <sup>1</sup> , 1152, 2304
Number of Splice Trays – 80813123, 80813122 <sup>1</sup> , 80813121, 80813779	12, 12, 6, 6	8, 8, 4, 4
Cable Ports <sup>2</sup>	7	
Cable Diameters <sup>3</sup>	0.093" – 1.38" (2.4 – 35.0 mm) and Flat Drop	
Ground Studs	7	
Configuration	Butt	
Application	Direct Bury, Below Grade, Pole/Wall, Aerial	
Ingress Protection	In accordance with Telcordia® GR-771-CORE, Buried, Underground; IP-68	
Size <sup>4</sup>	13.3" W x 29.4" L (338 x 747 mm)	

<sup>1</sup> The 80813122 thin-profile splice tray can only be used for cables that contain SpiderWeb Ribbon (SWR®) – AFL, Rollable Ribbon (RR) – OFS, Pliable Ribbon – Sumitomo, or FlexRibbon™ – Prysmian

<sup>2</sup> Multi-hole grommets allow for more than one cable to enter each cable port.

<sup>3</sup> Cables with diameters larger than 1.25" can only be used in end plate port numbers 3 and 6.

<sup>4</sup> Outermost part of the assembly; includes the sealing collar.

## ORGANIZER ASSEMBLIES

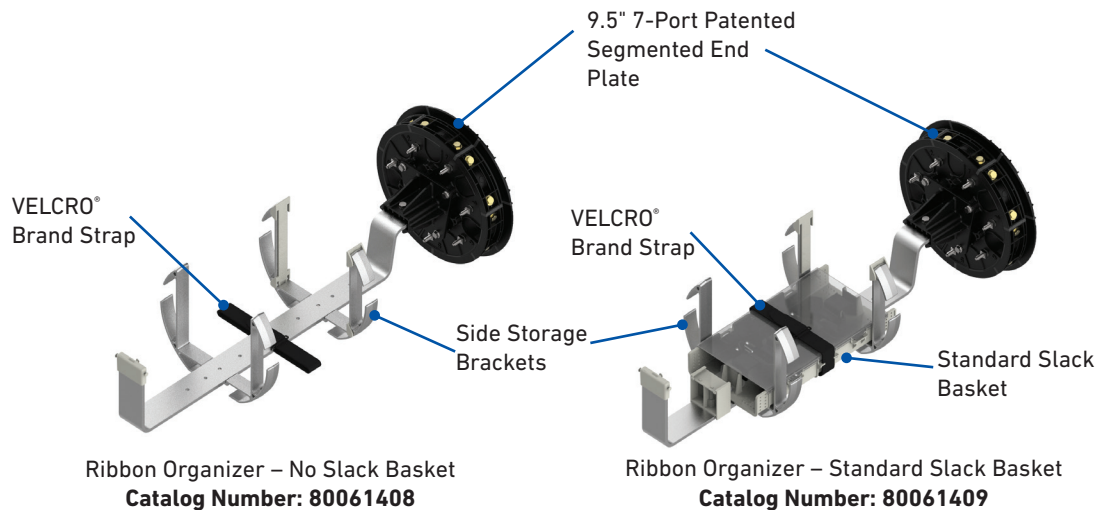

### COYOTE HD Dome Closure Kit Contents

Catalog Number	Description
80061408	COYOTE HD Dome Closure for Ribbon – Includes (2) 1-Hole Grommets 1.00" – 1.25" (25.4 – 31.8 mm) and (2) 1-Hole Grommets 1.25" – 1.38" (31.8 – 35.0 mm)
80061409	COYOTE HD Dome Closure with Slack Basket for Ribbon – Includes (2) 1-Hole Grommets 1.00" – 1.25" (25.4 – 31.8 mm), (2) 1-Hole Grommets 1.25" – 1.38" (31.8 – 35.0 mm), and (1) 6-Pack, 36" long of 0.25" ID Transition Tubing

All kits include (1) COYOTE HD End Plate Organizer, (1) Dome, (1) Gasket, (1) Collar, (4) 1-Hole Grommets, (1) 12-Pack of 20" Long 0.50" ID Spiral Tubing, and Cable Restraint Hardware.

Telcordia® is a registered trademark of Telcordia Technologies, Inc. now part of Ericsson. SWR® is a registered trademark of AFL. FlexRibbon™ is a registered trademark of Prysmian.

VELCRO® Brand is a registered trademark of Velcro BVBA.

## BUFFER TUBE APPLICATIONS

### Specifications

<b>Catalog Number</b>	<b>80061488</b>
Splice Capacity (Maximum) – Single Fusion (Thin, 80813123, 72 CT.), Single Fusion (Thin, 80813301, 108 CT.)	576, 864
Number of Splice Trays – 80813123, 80813301	8, 8
Cable Ports <sup>1</sup>	7
Cable Diameters	0.093" – 1.25" (2.4 – 31.8 mm) and Flat Drop
Ground Studs	7
Configuration	Butt
Application	Direct Bury, Below Grade, Pole/Wall, Aerial
Ingress Protection	In accordance with Telcordia® GR-771-CORE, Buried, Underground; IP-68
Size <sup>2</sup>	13.3" W x 29.4" L (338 x 747 mm)

<sup>1</sup> Multi-hole grommets allow for more than one cable to enter each cable port.

<sup>2</sup> Outermost part of the assembly; includes the sealing collar.

## BUFFER TUBE ORGANIZER ASSEMBLY

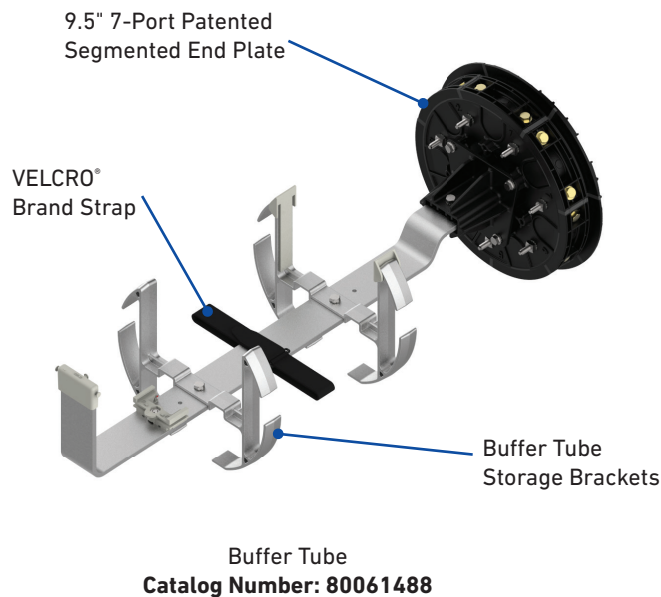

### COYOTE HD Dome Closure Kit Contents for Buffer Tube Applications

Catalog Number	Description
80061488	COYOTE HD Dome Closure for Single Fusion – Includes (2) 1-Hole Grommets 0.60" – 0.85" (15.2 – 21.6 mm), (2) 1-Hole Grommets 0.85" – 1.00" (21.6 – 25.4 mm)

All kits include (1) COYOTE HD End Plate Organizer, (1) Dome, (1) Gasket, (1) Collar, (4) 1-Hole Grommets, and Cable Restraint Hardware



## ACCESSORIES

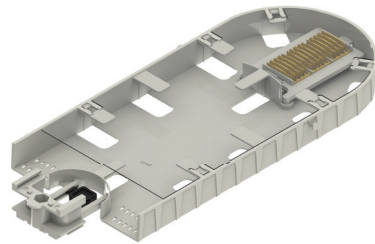

Deep Profile Mass Fusion Flip Tray  
288 Splice CT.  
**Catalog Number: 80813121**

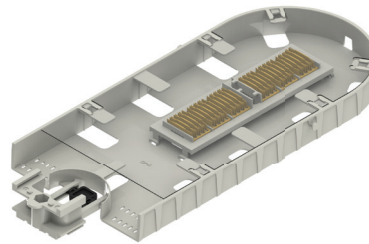

Deep Profile Mass Fusion Flip Tray  
576 Splice CT.  
**Catalog Number: 80813779**

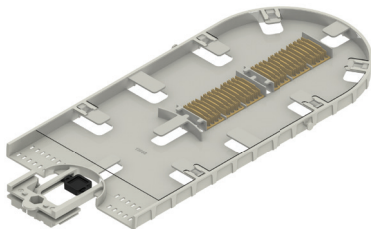

Thin Profile Mass Fusion Flip Tray  
288 Splice CT.  
**Catalog Number: 80813122**

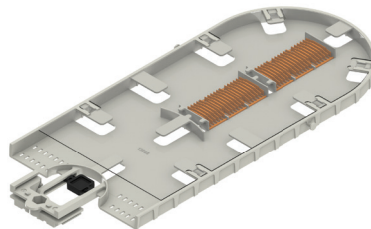

Thin Profile Single Fusion Flip Tray  
72 Splice CT.  
**Catalog Number: 80813123**

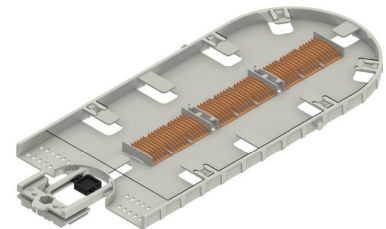

Thin Profile Single Fusion Flip Tray  
108 Splice CT.  
**Catalog Number: 80813301**

### COYOTE HD Dome Closure Accessories

Catalog Number	Description
80813121	Deep Profile Mass Fusion Flip Tray, 288 CT.
80813779	Deep Profile Mass Fusion Flip Tray, 576 CT.
80813122	Thin Profile Mass Fusion Flip Tray, 288 CT.
80813123	Thin Profile Single Fusion Flip Tray, 72 CT.
80813301	Thin Profile Single Fusion Flip Tray, 108 CT.
8004160	Heat Shrink Splice Protector Kit – Includes (50) 40 mm Mass Fusion
8004095	Heat Shrink Splice Protector Kit – Includes (50) 40 mm Single Fusion
8003717	Heat Shrink Splice Protector Kit – Includes (50) 60 mm Single Fusion
80813770	Shallow Slack Basket Kit for up to 432 Expressed Mass Fusion Applications
80813267	Deep Slack Basket (2.85" Deep) Kit for up to 864 Expressed Ribbon Applications. For the COYOTE HD (High-Density) Dome Closure and the COYOTE HD Stainless Steel Splice Case Only.
80061500	Breakout Kit for Unitube Ribbon Applications
COYEPFIX1	End Plate Fixture Assembly for 6.5" and 9.5" Domes
8003839	End Plate Kit for 9.5" Domes for cables under 1.25"
80061477	Latching Collar and End Plate Gasket for 9.5" Domes
80061201	Breakaway Bonding Plate for 9.5" Domes
80809205	Strength Member Bracket Kit – Includes (2) Short L-Brackets
800015236	Strength Member Bracket Kit – Includes (3) Long L-Brackets and (3) Hose Clamps
80808651	Strength Member Bracket Kit – Includes (4) Long L-Brackets
80813361	Extended Strength Member Bracket Kit for Large Central Strength Members – Includes (2) Long L-Brackets and Lugs
80813124	Splice Tray Locking Pin Kit – Includes (5) Tray Locking Pins
80813125	Splice Tray Tether Kit – Includes (6) Splice Tray Tether Straps

## MOUNTING BRACKETS

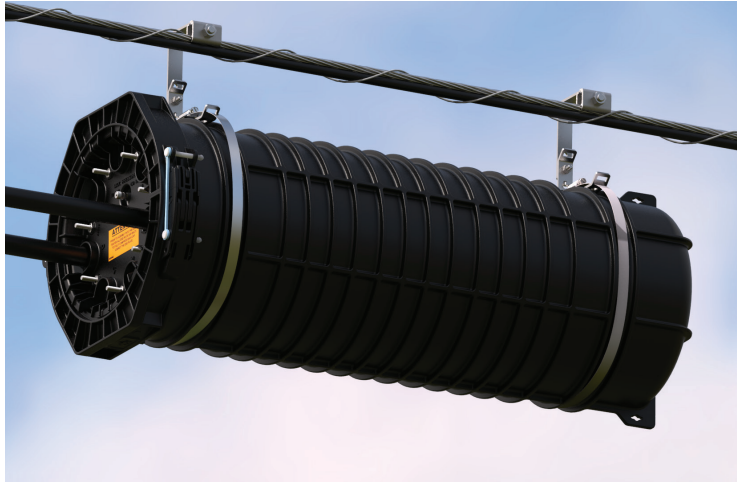

Adjustable Aerial Offset Mounting Bracket for Strand Applications  
**Catalog Number: 8004037**

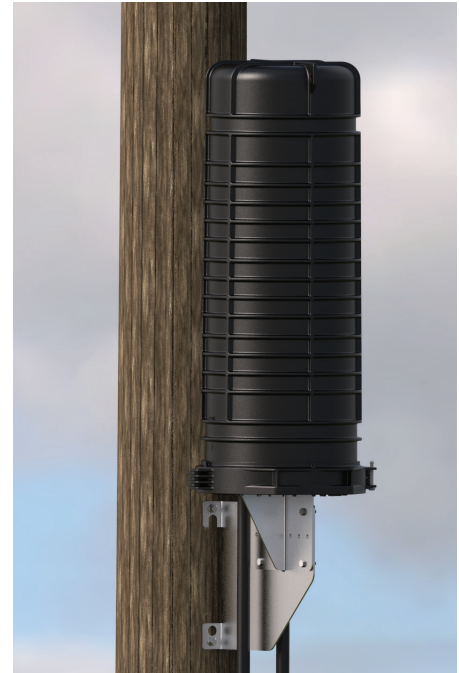

Pole/Wall Mounting Bracket  
**Catalog Number: 8003942**

### COYOTE HD Dome Closure Mounting Brackets

Catalog Number	Description
8003940	Aerial Mounting Bracket – Strand Applications
8004037	Aerial Adjustable Offset Mounting Bracket – Strand Applications
8003869	Aerial Mounting Bracket – ADSS Applications
8004038	Aerial Adjustable Offset Mounting Bracket – ADSS Applications
8003942	Pole/Wall Mounting Bracket
8003835	Universal Mounting Bracket – Handhole Applications
8003941	Swing Arm for Handhole Applications
8004003	Manhole Support Bracket

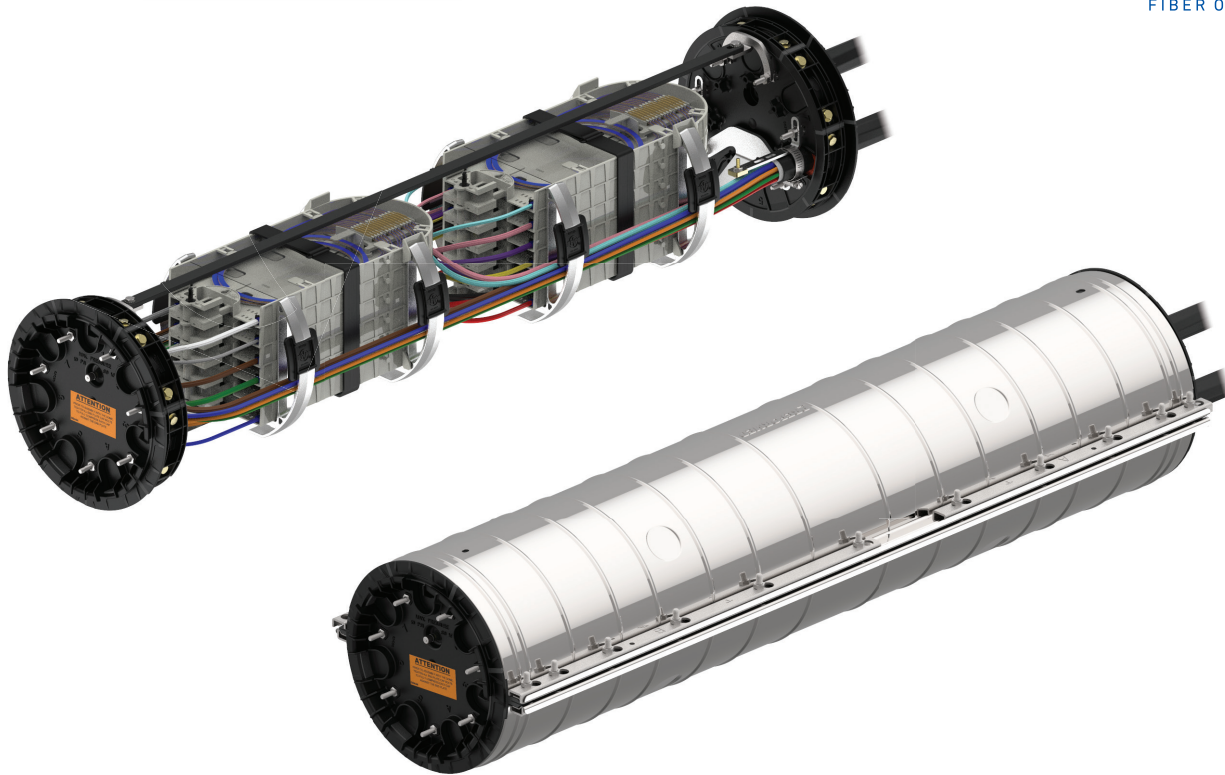

## COYOTE® HD STAINLESS STEEL SPLICE CASE 9.5" X 45"

The **COYOTE HD (High-Density) Stainless Steel Splice Case** combines the durable stainless steel outer shell from PLP's ARMADILLO® splice cases with the patented segmented end plates used in COYOTE closures to create a unique hybrid closure. The field-proven stainless steel shells can withstand even the most severe environments, providing the ultimate protection for high-count splice applications. The new organizer architecture provides open access for fiber routing, reduces cable sheath openings, and simplifies assembly. The HD Stainless offers the ultimate level of flexibility and protection to address your high-count network needs.

### FEATURES AND BENEFITS

- Maximum Splice Capacity of 3456 or 6912 depending on cable construction
- 7-Port segmented end plate design provides independent access to each cable port without disrupting surrounding cables
- Stainless steel shells and the LOCKBAR™ Fastening System have been a trusted industry solution for many years
- Multiple splice tray designs to support single- or mass-fusion splicing, or a combination of both
- Modular tray design permits trays to hinge upward or be removed from the stack to allow multiple splicers to work simultaneously
- Grommet range now accepts fiber optic cable entry of up to 1.38" in diameter
- Designed and tested in accordance with Telcordia® GR-771-CORE Buried, Underground, IP-68 Rated Requirement

## RELIABLE AND ADAPTABLE COMPONENTS

The **COYOTE® HD Stainless** combines PLP's most successful lines into a unique hybrid closure that offers superior performance and endless versatility for virtually any high-count splicing application. PLP's **ARMADILLO®** Stainless Steel Splice Cases have been the industry standard since 1975, protecting communication cables under the most severe conditions. The stainless steel shells are

precision formed with an inner neoprene liner. When combined with the **LOCKBAR™** fastening system, the closure has a gasket sealing system that does not require a re-entry kit or cleaning upon re-entry. The patented segmented end plates used in COYOTE closures have been proven to decrease assembly time, thereby reducing overall costs.

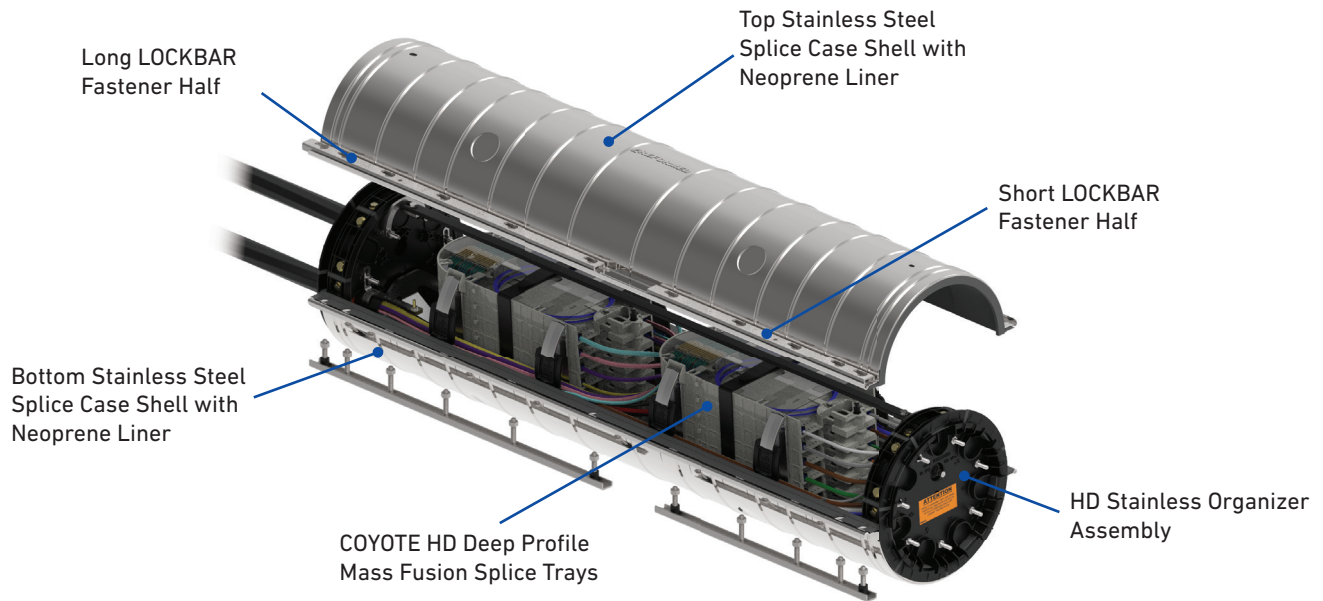

Specifications	WITHOUT Slack Basket	WITH Standard Slack Basket	WITH Deep Metal Slack Basket
<b>Catalog Number</b>	<b>80061637, 80061675</b>	<b>80061638, 80061676</b>	<b>80061639, 80061677</b>
Splice Capacity (Maximum) – Single Fusion (Thin, 80813123), Mass Fusion (Thin, 80813122), Mass Fusion (Deep, 80813121), Mass Fusion (Deep, 80813779)	1728, 6912 <sup>1</sup> , 3456, 6912	1440, 5760 <sup>1</sup> , 2880, 5760	1296, 5184 <sup>1</sup> , 2592, 5184
Number of Splice Trays – 80813123, 80813122 <sup>1</sup> , 80813121, 80813779	24, 24, 12, 12	20, 20, 10, 10	18, 18, 9, 9
Cable Ports <sup>2</sup>	14		
Cable Diameters <sup>3</sup>	0.093" – 1.38" (2.4 – 35.0 mm)		
Ground Studs	14		
Configuration	In-Line or Butt		
Application	Direct Bury, Below Grade, Pole/Wall, Aerial		
Ingress Protection	In accordance with Telcordia® GR-771-CORE, Buried, Underground; IP-68		
Size <sup>4</sup>	11.8" W x 45.0" L (300 x 1143 mm)		

<sup>1</sup> The 80813122 thin-profile splice tray can only be used for cables that contain SpiderWeb Ribbon (SWR) – AFL, Rollable Ribbon (RR) – OFS, Pliable Ribbon – Sumitomo, or FlexRibbon™ – Prysmian

<sup>2</sup> Multi-hole grommets allow for more than one cable to enter each cable port.

<sup>3</sup> Cables with diameters larger than 1.25" can only be used in end plate port numbers 3 and 6.

<sup>4</sup> Outermost part of the assembly.

Telcordia® is a registered trademark of Telcordia Technologies, Inc. now part of Ericsson. SWR® is a registered trademark of AFL. FlexRibbon™ is a registered trademark of Prysmian.



## RIBBON ORGANIZER ASSEMBLIES

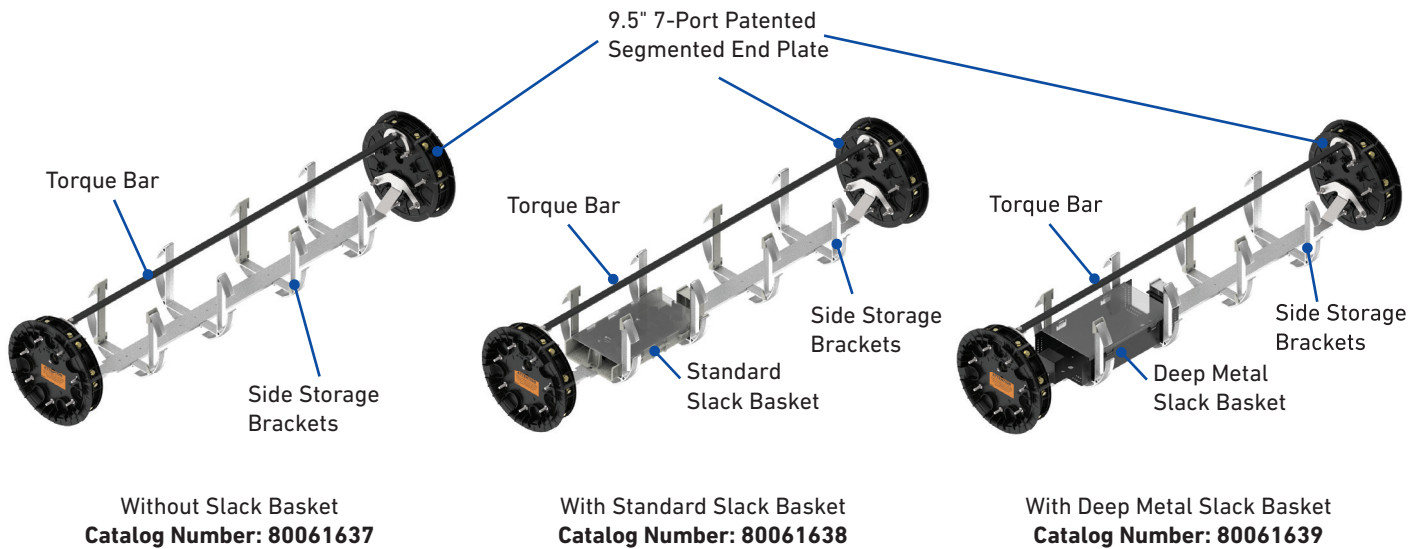

### COYOTE HD Stainless Kit Contents

Catalog Number	Description
80061637	COYOTE HD Stainless for Ribbon – Includes (4) 1-Hole Grommets 0.85" – 1.00" (21.6 – 25.4 mm), (2) 1-Hole Grommets 1.00" – 1.25" (25.4 – 31.8 mm), and (2) 1-Hole Grommets 1.25" – 1.38" (31.8 – 35.0 mm)
80061638	COYOTE HD Stainless with Standard Slack Basket for Ribbon – Includes (4) 1-Hole Grommets 0.85" – 1.00" (21.6 – 25.4 mm), (2) 1-Hole Grommets 1.00" – 1.25" (25.4 – 31.8 mm), (2) 1-Hole Grommets 1.25" – 1.38" (31.8 – 35.0 mm), and (2) 6-Pack, 36" long of 0.25" ID Transition Tubing
80061639	COYOTE HD Stainless with Metal Slack Basket for Ribbon – Includes (4) 1-Hole Grommets 0.85" – 1.00" (21.6 – 25.4 mm), (2) 1-Hole Grommets 1.00" – 1.25" (25.4 – 31.8 mm), and (2) 1-Hole Grommets 1.25" – 1.38" (31.8 – 35.0 mm), and (2) 6-Pack, 36" long of 0.25" ID Transition Tubing
80061675	COYOTE HD Stainless for Ribbon, In-Line Applications - Includes (4) 1-Hole Grommets 0.85" - 1.00" (21.6 - 25.4 mm), (2) 1-Hole Grommets 1.00" - 1.25" (25.4 - 31.8 mm), (2) 1-Hole Grommets 1.25" - 1.38" (31.8 - 35.0 mm), and (2) Blank Grommets
80061676	COYOTE HD Stainless with Standard Slack Basket for Ribbon, In-Line Applications - Includes (4) 1-Hole Grommets 0.85" - 1.00" (21.6 - 25.4 mm), (2) 1-Hole Grommets 1.00" - 1.25" (25.4 - 31.8 mm), (2) 1-Hole Grommets 1.25" - 1.8" (31.8 - 35.0 mm), (2) Blank Grommets, and (2) 6-Pack, 36" Long of 0.25" ID Transition Tubing
80061677	COYOTE HD Stainless with Deep Metal Slack Basket for Ribbon, In-Line Applications - Includes (4) 1-Hole Grommets 0.85" - 1.00" (21.6 - 25.4 mm), (2) 1-Hole Grommets 1.00" - 1.25" (25.4 - 31.8 mm), (2) 1-Hole Grommets 1.25" - 1.38" (31.8 - 35.0 mm), (2) Blank Grommets, and (2) 6-Pack, 36" Long of 0.25" ID Transition Tubing

All kits include (1) COYOTE HD Stainless End Plate Organizer, (1) Shell Kit, (1) LOCKBAR™ Fasteners, (8) 1-Hole Grommets, (2) 12-pack, 20" long of 3/8" ID Split Braided Wrap, Black, (1) 9.5" Bonding Plate and Cable Restraint Hardware.

## ACCESSORIES AND MOUNTING BRACKETS

### COYOTE HD Stainless Accessories

Catalog Number	Description
80813121	Deep Profile Mass Fusion Flip Tray, 288 CT.
80813779	Deep Profile Mass Fusion Flip Tray, 576 CT.
80813122	Thin Profile Mass Fusion Flip Tray, 288 CT.
80813123	Thin Profile Single Fusion Flip Tray, 72 CT.
80813301	Thin Profile Single Fusion Flip Tray, 108 CT.
8004160	Heat Shrink Splice Protector Kit – Includes (50) 40 mm Mass Fusion
8004095	Heat Shrink Splice Protector Kit – Includes (50) 40 mm Single Fusion
8003717	Heat Shrink Splice Protector Kit – Includes (50) 60 mm Single Fusion
80813770	Standard Slack Basket Kit for up to 432 Expressed Mass Fusion Applications
80813267	Deep Slack Basket (2.85" Deep) Kit for up to 864 Expressed Ribbon Applications. For the COYOTE HD (High-Density) Dome Closure and the COYOTE HD Stainless Steel Splice Case Only
80061500	Breakout Kit for Unitube Ribbon Applications
COYEPFIX1	End Plate Fixture Assembly for 6.5" and 9.5" Domes
8003839	End Plate Kit for 9.5" Domes for cables under 1.25"
80061201	Breakaway Bonding Plate for 9.5" Domes
80809205	Strength Member Bracket Kit – Includes (2) Short L-Brackets
800015236	Strength Member Bracket Kit – Includes (3) Long L-Brackets and (3) Hose Clamps
80808651	Strength Member Bracket Kit – Includes (4) Long L-Brackets
80813124	Splice Tray Locking Pin Kit – Includes (5) Tray Locking Pins
8000428	Socket Tool Kit – Includes (1) Ratchet Wrench, (1) Deep Well Socket 7/16", (1) Deep Well Socket 1/2", (1) 6" Long Extension and (1) Torque Wrench
8000420	Socket Tool Kit – Includes (1) Ratchet Wrench, (1) Deep Well Socket 7/16", (1) Deep Well Socket 1/2", and (1) 6" Long Extension
80803967	Torque Wrench with Ratchet Head 3/8" Drive
80801151	Deep Well Socket 1/2"

### COYOTE HD Stainless Mounting Brackets

Catalog Number	Description
8003426	Adjustable Aerial Mounting Bracket – Strand Applications
8004203	Manhole Support Bracket

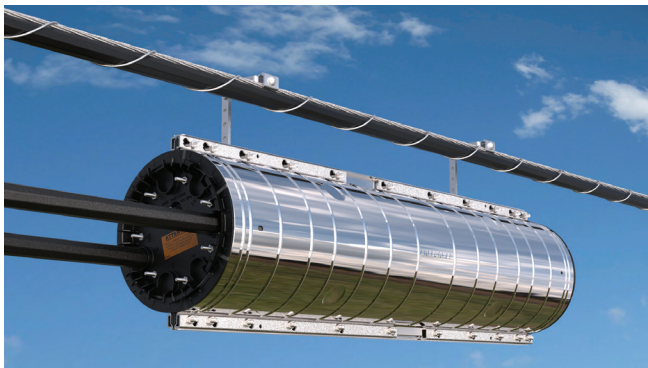

Adjustable Aerial Mounting Bracket for Strand Application  
Catalog Number: 8003426

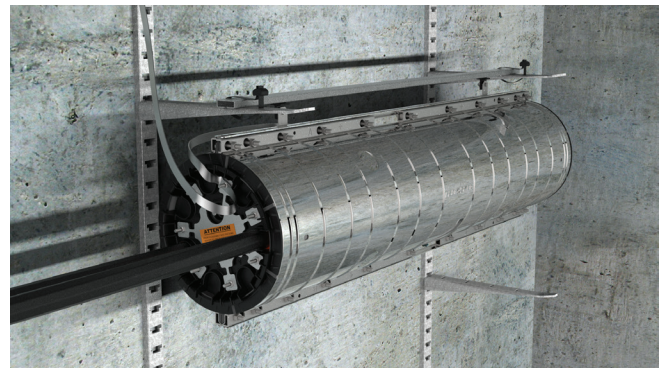

Manhole Support Bracket  
Catalog Number: 8004203

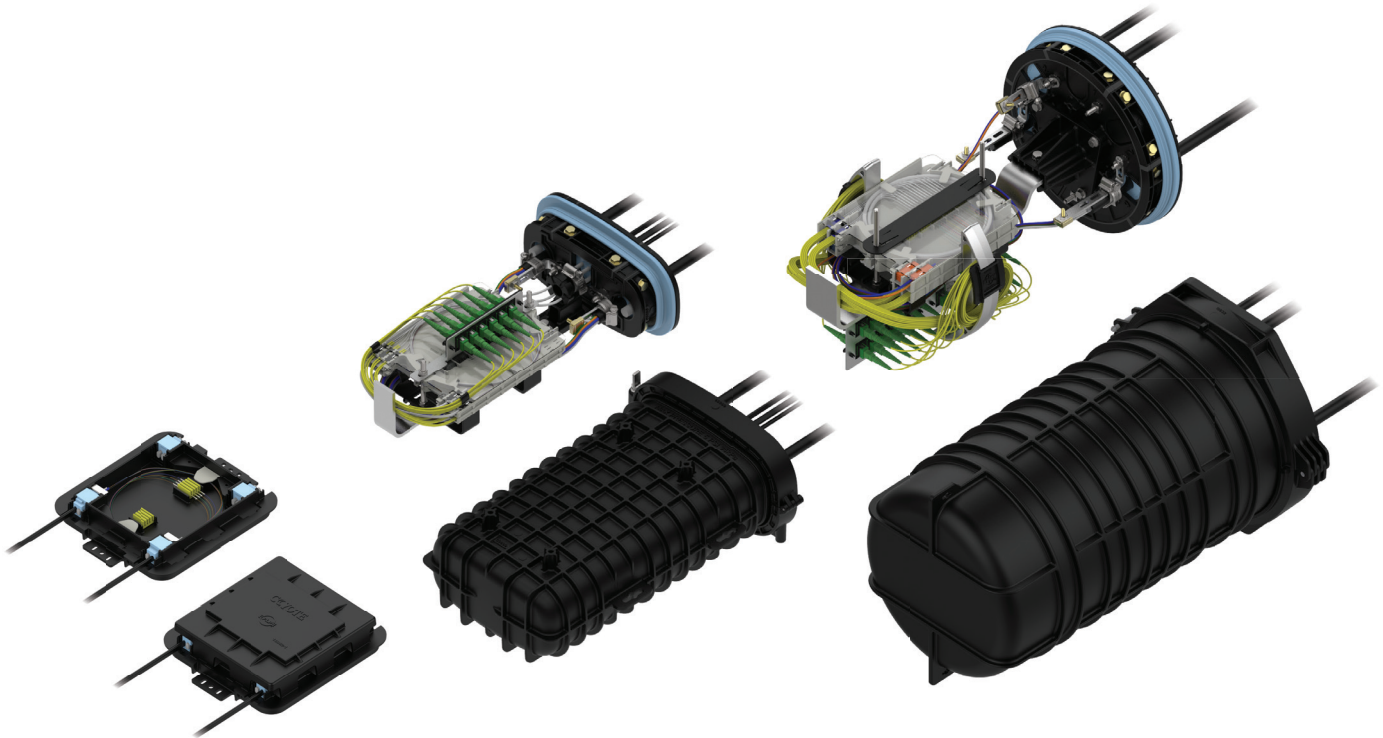

## COYOTE® CROSS-CONNECT CLOSURES

**COYOTE Cross-Connect Closures** merge the craft-friendly functions and features found through out the COYOTE fiber optic closure family with the benefits of plug and play technology. COYOTE Cross-Connect Closures come in a variety of sizes and utilize the same grommet sealing system and COYOTE splice trays used in the traditional COYOTE fiber optic closures. They can be populated with a variety of adapter types and are compatible with bare fiber or pre-connectorized splitters. These closures are ideal for applications where services need to be redirected often without having to re-splice each time.

### FEATURES AND BENEFITS

- Provides protected fiber splicing and connectivity
- Can be quickly assembled and re-entered
- Flexible grommet sealing technology supports a wide range of flat and round cable profiles
- Multiple splice tray designs support single fusion splicing and splitter retention
- Compatible with standard pigtails or pre-connectorized splitters
- Compatible with SC, LC, FC, and ST style of adapters
- Provides 2 to 96 connections depending on the closure size and adapter type

## SPECIFICATIONS



### COYOTE DTC Cross-Connect Closure

<b>Catalog Number</b>	<b>800013911, 800013853</b>	
Splice Capacity (Maximum) - Single Fusion	24	
Cable Port Quantity	4 (2 on each end)	
Cable Diameters <sup>1</sup>	0.17" – 0.32" (4.3 – 8.1 mm) Flat Drop, ROC™ Drop	
Configuration	In-Line or Butt	
Application	Direct Buried, Below Grade, Pole/Wall, Aerial	
Ingress Protection	In accordance with Telcordia® GR-771-CORE, Buried, Underground, IP-68	
Size	9.1" L x 7.6" W x 1.8" D (231 x 193 x 45 mm)	
Adapter Port Quantity (Maximum)	2 SC or 4 LC	

Kit Contents	800013911	Includes (2) 1-Hole Grommet 0.17" – 0.32" (4.3 – 8.1 mm), (2) 2-Hole Flat Drop Grommet, (2) LITE-GRIP® Single Fusion Splice Blocks, (1) LITE-GRIP Mass Fusion Splice Block, (1) Bulkhead Bracket, (2) SC/APC adapters, & (4) 2 mm jacketed pigtails
	800013853	Includes (2) 1-Hole Grommet 0.17" – 0.32" (4.3 – 8.1 mm), (2) 2-Hole Flat Drop Grommet, (2) LITE-GRIP Single Fusion Splice Blocks, (1) LITE-GRIP Mass Fusion Splice Block, and (1) Bulkhead Bracket <b>NOTE: Adapters and pigtails sold separately.</b>

<sup>1</sup>This is the maximum range of cable diameters this closure can accept and does not reflect the cable diameter range for the closure kits listed above. Check the grommets provided with each closure kit to determine the acceptable cable diameter range for that closure kit.

### COYOTE LCC Cross-Connect Closure

<b>Catalog Number</b>	<b>800013854</b>	
Splice Capacity (Maximum) - Single Fusion	16	
Cable Port Quantity	2 (1 on each end)	
Cable Diameters <sup>1</sup>	0.093" – 1.00" (2.4 – 25.4 mm) and Flat Drop	
Configuration	In-Line or Butt	
Application	Direct Buried, Below Grade, Pole/Wall, Aerial	
Ingress Protection	In accordance with Telcordia® GR-771-CORE, Buried, Underground, IP-68	
Size	14.0" L x 6.5" W x 2.5" D (356 x 165 x 64 mm)	
Adapter Port Quantity (Maximum)	4 SC or 8 LC	

Kit Contents	800013854	Includes (1) 7-Hole Grommet [1 Hole: 0.42" – 0.60" (10.7 – 15.2 mm) and 6 Holes: 0.125" – 0.250" (3.2 – 6.4 mm) and Flat Drop Cable], (1) 8-Hole Grommet 0.125" – 0.250" (3.2 – 6.4 mm) and Flat Drop Cable, (1) Splice Platform, (3) LITE-GRIP Single Fusion Splice Blocks, (1) Dual Strength Member Bracket, (1) "L" Strength Member Bracket, and (1) Bulkhead Bracket <b>NOTE: Adapters and pigtails sold separately</b>
--------------	-----------	---

<sup>1</sup>This is the maximum range of cable diameters this closure can accept and does not reflect the cable diameter range for the closure kits listed above. Check the grommets provided with each closure kit to determine the acceptable cable diameter range for that closure kit.





## SPECIFICATIONS

### COYOTE In-Line RUNT Cross-Connect Closure



Catalog Number		80061172, 80061173
Splice Capacity (Maximum) - Single Fusion (Low Profile, 80809958), Single Fusion (Low Profile, 80813152)		48, 72
Number of Splice Trays – 80809958, 80813152		2, 2
Cable Port Quantity		4 (2 on each end)
Cable Diameters <sup>1</sup>		0.093" – 1.20" (2.4 – 30.5 mm) and Flat Drop
Configuration		In-Line or Butt
Application		Direct Buried, Below Grade, Pole/Wall, Aerial
Ingress Protection		In accordance with Telcordia® GR-771-CORE, Buried, Underground; IP-68
Size		18.7" L x 10.0" W x 3.7" H (475 x 254 x 94 mm)
Adapter Port Quantity (Maximum)		8 SC or 16 LC
Kit Contents	80061172	Includes (2) 1-Hole Grommets 0.40" – 0.60" (10.2 – 15.2 mm), (1) 2-Hole Grommet 0.42" – 0.60" (10.7 – 15.2 mm), and (1) 4-Hole Grommet 0.30" – 0.43" (7.6 – 10.9 mm), (1) Splice Tray - Cat. No.80809958, (1) 6 Position Bulkhead Bracket, (6) SC/ APC adapters, and (12) 2 mm jacketed pigtails
	80061173	Includes: (2) 1-Hole Grommets 0.40" – 0.60" (10.2 – 15.2 mm), (1) 2-Hole Grommet 0.42" – 0.60" (10.7 – 15.2 mm), and (1) 4-Hole Grommet 0.30" – 0.43" (7.6 – 10.9 mm), (1) Splice Tray - Cat. No. 80809958, (1) 8 Position Bulkhead Bracket, (8) SC/ APC adapters, and (16) 2 mm jacketed pigtails

<sup>1</sup>This is the maximum range of cable diameters this closure can accept and does not reflect the cable diameter range for the closure kits listed above. Check the grommets provided with each closure kit to determine the acceptable cable diameter range for that closure kit.

### COYOTE Dual Chamber Terminal Cross-Connect Closure



Catalog Number		8006956
Splice Capacity (Maximum) - Single Fusion (Low Profile, 80809958), Single Fusion (Low Profile, 80813152), Single Fusion (Deep Profile, 80808945)		96, 144, 80
Number of Splice Trays – 80809958, 80813152, 80808945		4, 4, 2
Cable Port Quantity		6 (4 on each end, 2 on opposite end)
Cable Diameters <sup>1</sup>		0.093" – 1.20" (2.4 – 30.5 mm) and Flat Drop
Configuration		In-Line or Butt
Application		Direct Buried, Below Grade, Pole/Wall, Aerial
Ingress Protection		In accordance with Telcordia® GR-771-CORE, Buried, Underground, IP-68
Size		18.7" L x 10.0" W x 7.0" H (475 x 254 x 178 mm)
Adapter Port Quantity (Maximum)		8 SC or 16 LC
Kit Contents	8006956	Includes (2) 1-Hole Grommets 0.40" – 0.60" (10.2 – 15.2 mm), (1) 2-Hole Grommet 0.42" – 0.60" (10.7 – 15.2 mm), and (1) 4-Hole Grommet 0.30" – 0.43" (7.6 – 10.9 mm), (1) Splice Tray - Cat. No. 80807701, (1) Shroud Kit, (1) 6 Position SC/APC Adapter Module, and (6) 2 mm jacketed pigtails

<sup>1</sup>This is the maximum range of cable diameters this closure can accept and does not reflect the cable diameter range for the closure kits listed above. Check the grommets provided with each closure kit to determine the acceptable cable diameter range for that closure kit.

Telcordia® is a registered trademark of Telcordia Technologies, Inc., now part of Ericsson.

## SPECIFICATIONS



### COYOTE ONE Dome Cross-Connect Closure

Catalog Number		800013856
Splice Capacity (Maximum) – Single Fusion (Low Profile, 80809958), Single Fusion (Low Profile, 80813152)		48, 72
Number of Splice Trays – 80809958, 80813152		2, 2
Cable Port Quantity		3
Cable Diameters <sup>1</sup>		0.093" – 0.85" (2.4 – 21.6 mm) and Flat Drop
Configuration		Butt
Application		Direct Buried, Below Grade, Pole/Wall, Aerial
Ingress Protection		In accordance with Telcordia® GR-771-CORE, Buried, Underground, IP-68
Size		16.0" L x 10.8" W x 5.7" H (406 x 274 x 145 mm)
Adapter Port Quantity (Maximum)		12 SC or 16 LC
Kit Contents	800013856	Includes (2) 2-Hole Grommet 0.42" – 0.60" (10.7 – 15.2 mm), (1) 6-Hole Grommet 0.125" – 0.250" (3.2 – 6.4 mm) and Flat Drop Cable, and (1) Bulkhead Bracket <b>NOTE: Adapter modules and pigtails sold separately.</b>

<sup>1</sup>This is the maximum range of cable diameters this closure can accept and does not reflect the cable diameter range for the closure kits listed above. Check the grommets provided with each closure kit to determine the acceptable cable diameter range for that closure kit.

### COYOTE 6.5" x 17" Dome Cross-Connect Closure



Catalog Number		CXD617B-001
Splice Capacity (Maximum) - Single Fusion (Low Profile, 80809958), Single Fusion (Low Profile, 80813152), Single Fusion (Deep Profile, 80808945)		96, 144, 80
Number of Splice Trays – 80809958, 80813152, 80808945		4, 4, 2
Cable Port Quantity		4
Cable Diameters <sup>1</sup>		0.093" – 1.25" (2.4 – 31.8 mm) and Flat Drop
Configuration		Butt
Cable Types		Buffer Tube Only
Application		Direct Buried, Below Grade, Pole/Wall, Aerial
Ingress Protection		In accordance with Telcordia® GR-771-CORE, Buried, Underground, IP-68
Size		8.6" W x 17.9" L (218 x 464 mm)
Adapter Port Quantity (Maximum)		24 SC or 48 LC
Kit Contents	CXD617B-001	Includes (2) 1-Hole Grommets 0.40" – 0.60" (10.2 – 15.2 mm), (2) 1-Hole Grommets 0.60" – 0.85" (15.2 – 21.6 mm), and (1) 16 Position Bulkhead Bracket <b>NOTE: Adapters and pigtails sold separately.</b>

<sup>1</sup>This is the maximum range of cable diameters this closure can accept and does not reflect the cable diameter range for the closure kits listed above. Check the grommets provided with each closure kit to determine the acceptable cable diameter range for that closure kit.



## SPECIFICATIONS

### COYOTE 6.5" x 17" Dome Cross-Connect Closure



<b>Catalog Number</b>		<b>CXD617U-001</b>
Splice Capacity (Maximum) - Single Fusion (Low Profile, 80809958), Single Fusion (Low Profile, 80813152), Single Fusion (Deep Profile, 80808945)		96, 144, 80
Number of Splice Trays – 80809958, 80813152, 80808945		4, 4, 2
Cable Port Quantity		4
Cable Diameters <sup>1</sup>		0.093" – 1.25" (2.4 – 31.8 mm) and Flat Drop
Configuration		Butt
Cable Types		Buffer Tube or Ribbon
Application		Direct Buried, Below Grade, Pole/Wall, Aerial
Ingress Protection		In accordance with Telcordia® GR-771-CORE, Buried, Underground, IP-68
Size		8.6" W x 17.9" L (218 x 464 mm)
Adapter Port Quantity (Maximum)		24 SC or 48 LC
Kit Contents	CXD617U-001	Includes (2) 1-Hole Grommets 0.40" – 0.60" (10.2 – 15.2 mm), (2) 1-Hole Grommets 0.60" – 0.85" (15.2 – 21.6 mm), (1) Transition Tubing Kit, (2) Transport Tubing Kits, and (1) 16 Position Bulkhead Bracket <b>NOTE: Adapters and pigtails sold separately.</b>

<sup>1</sup>This is the maximum range of cable diameters this closure can accept and does not reflect the cable diameter range for the closure kits listed above. Check the grommets provided with each closure kit to determine the acceptable cable diameter range for that closure kit.

### COYOTE 6.5" x 22" Dome Cross-Connect Closure



<b>Catalog Number</b>		<b>CXD622B-001</b>
Splice Capacity (Maximum) - Single Fusion (Standard Profile, 80810086), Single Fusion (Deep Profile, LGSTS72)		108, 144
Number of Splice Trays – 80810086, LGSTS72		3, 2
Cable Port Quantity		4
Cable Diameters <sup>1</sup>		0.093" – 1.25" (2.4 – 31.8 mm) and Flat Drop
Configuration		Butt
Cable Types		Buffer Tube Only
Application		Direct Buried, Below Grade, Pole/Wall, Aerial
Ingress Protection		In accordance with Telcordia® GR-771-CORE, Buried, Underground, IP-68
Size		8.6" W x 22.6" L (218 x 574 mm)
Adapter Port Quantity (Maximum)		48 SC or 96 LC
Kit Contents	CXD622B-001	Includes (2) 1-Hole Grommets 0.40" – 0.60" (10.2 – 15.2 mm), (2) 1-Hole Grommets 0.60" – 0.85" (15.2 – 21.6 mm), and (1) 32 Position Bulkhead Bracket <b>NOTE: Adapters and pigtails sold separately.</b>

<sup>1</sup>This is the maximum range of cable diameters this closure can accept and does not reflect the cable diameter range for the closure kits listed above. Check the grommets provided with each closure kit to determine the acceptable cable diameter range for that closure kit.

## SPECIFICATIONS



### COYOTE 6.5" x 22" Dome Cross-Connect Closure

Catalog Number		CXD622U-001
Splice Capacity (Maximum) - Single Fusion (Standard Profile, 80810086), Single Fusion (Deep Profile, LGSTS72)		108, 144
Number of Splice Trays – 80810086, LGSTS72		3, 2
Cable Port Quantity		4
Cable Diameters <sup>1</sup>		0.093" – 1.25" (2.4 – 31.8 mm) and Flat Drop
Configuration		Butt
Cable Types		Buffer Tube or Ribbon
Application		Direct Buried, Below Grade, Pole/Wall, Aerial
Ingress Protection		In accordance with Telcordia® GR-771-CORE, Buried, Underground, IP-68
Size		8.6" W x 22.6" L (218 x 574 mm)
Adapter Port Quantity (Maximum)		48 SC or 96 LC
Kit Contents	CXD622U-001	Includes: (2) 1-Hole Grommets 0.40" – 0.60" (10.2 – 15.2 mm), (2) 1-Hole Grommets 0.60" – 0.85" (15.2 – 21.6 mm), (1) Transition Tubing Kit, (2) Transport Tubing Kits, and (1) 32 Position Bulkhead Bracket <b>NOTE: Adapters and pigtails sold separately.</b>

<sup>1</sup>This is the maximum range of cable diameters this closure can accept and does not reflect the cable diameter range for the closure kits listed above. Check the grommets provided with each closure kit to determine the acceptable cable diameter range for that closure kit.



### COYOTE 9.5" x 19" Dome Cross-Connect Closure

Catalog Number		CXD91901
Splice Capacity (Maximum) - Single Fusion (Low Profile, 80809958), Single Fusion (Low Profile, 80813152), Single Fusion (Deep Profile, 80808945)		240, 360, 200
Number of Splice Trays – 80809958, 80813152, 80808945		10, 10, 5
Cable Port Quantity		7
Cable Diameters <sup>1</sup>		0.093" – 1.25" (2.4 – 31.8 mm) and Flat Drop
Configuration		Butt
Application		Direct Buried, Below Grade, Pole/Wall, Aerial
Ingress Protection		In accordance with Telcordia® GR-771-CORE, Buried, Underground, IP-68
Size		13.3" W x 20.4" L (338 x 509 mm)
Adapter Port Quantity (Maximum)		48 SC or 96 LC
Kit Contents	CXD91901	Includes: (2) 2-Hole Grommet 0.42" – 0.60" (10.7 – 15.2 mm) and (2) 1-Hole Grommets 0.60" – 0.85" (15.2 – 21.6 mm) <b>NOTE: Adapter modules and pigtails sold separately.</b>

<sup>1</sup>This is the maximum range of cable diameters this closure can accept and does not reflect the cable diameter range for the closure kits listed above. Check the grommets provided with each closure kit to determine the acceptable cable diameter range for that closure kit.



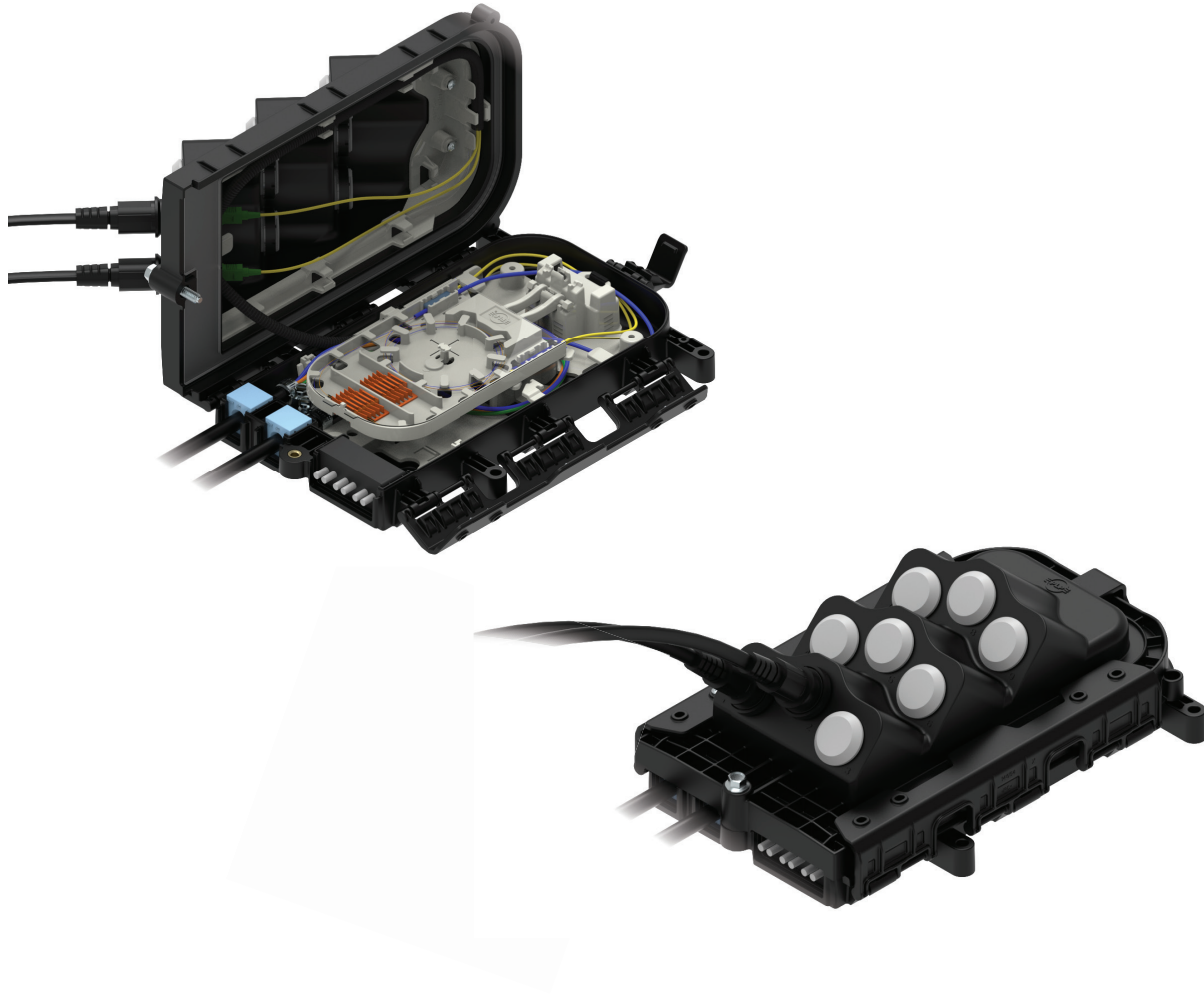

# SECTION 3 HARDENED CONNECTIVITY CLOSURES

COYOTE® FIBER OPTIC SOLUTIONS

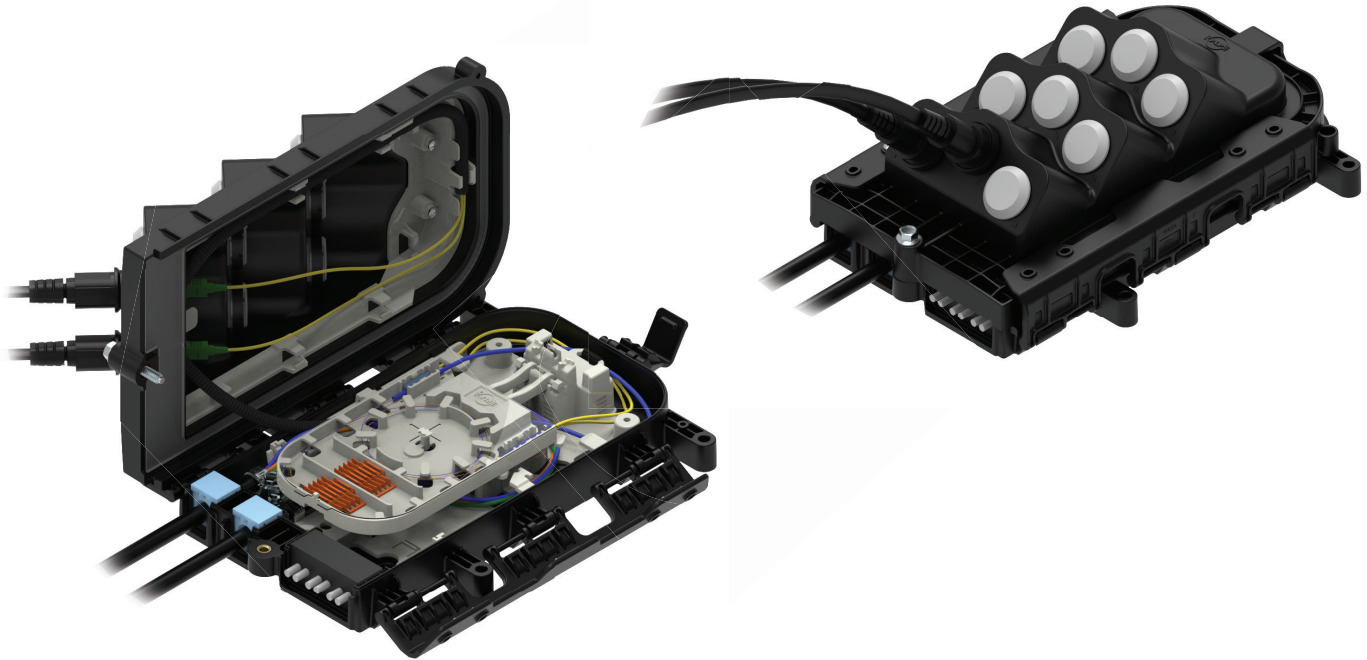

## COYOTE® STP PRO TERMINAL CLOSURE

### STP PRO SERIES CLOSURE

Utilizing a similar design to PLP's original COYOTE STP Closure, the **STP Pro Terminal Closure** is a compact drop distribution closure that is designed to provide maximum adaptability to various splicing and connectivity applications. The STP Pro Terminal Closure easily accommodates unique splicing needs with interchangeable organizers supporting diverse connectivity requirements, up to nine OptiTap® adapter ports, and a universal cable restraint system. The robust latch system, conical grommet design, and integrated over-molded cover enable quick re-entry that is designed to provide a secure seal over a wide range of cable profiles.

### FEATURES AND BENEFITS

- The dual chamber design of the STP-XL provides independent access to both the splice/slack storage chamber and the drop connection chamber, whereas the single chamber STP-L provides a more compact option
- Integrated over-molded cover options are quickly assembled and removed from the closure
- Robust latch system and unique grommet design enable quick re-entry and re-use
- Universal cable restraint system works across the entire STP Pro platform
- Various base designs allow for a multitude of combinations of feed and drop cables in a compact design
- Conical grommet options support a wide range of cable diameters
- Available in a 6-Port or 9-Port OptiTap cover
- Designed to permit field installation and removal of hardened adapters
- Provided with SC/APC pigtail kits
- Screws allow the cover to be attached to the closure's side latches for a hinged cover or to prevent tampering
- Constructed from a high-strength, UV-stabilized, flame-retardant material
- Designed and tested in accordance to Telcordia® GR-771-CORE Buried, Underground, IP-68 Rated Requirements

# COYOTE® STP-LT

## Specifications

Catalog Number	STP-L3T-XP-24-001 through STP-L4T-XP-24-003
Cable Ports <sup>1</sup>	3 or 4
Cable Diameters	0.170" - 0.550" (4.3 - 14 mm), Round, Flat, and ROC™ Drop Cables
Configuration	Butt
Application	Direct Buried, Below Grade, Pole/Wall, and Aerial
Ingress Protection	In accordance to Telcordia® GR-771-CORE, Buried, Underground; IP-68
Size	11.8" L x 7.8" W x 4.1" H <sup>2</sup> (300 mm x 198 mm x 104 mm)

<sup>1</sup> Multi-hole grommets allow for more than one cable to enter each cable port.

## STP-LT BASE OPTIONS

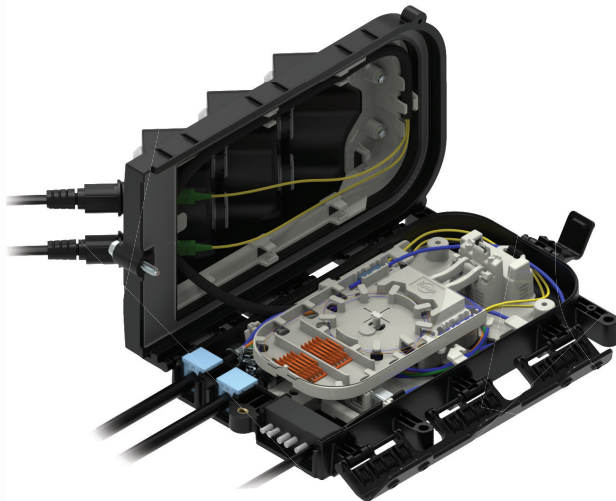

STP-L3T

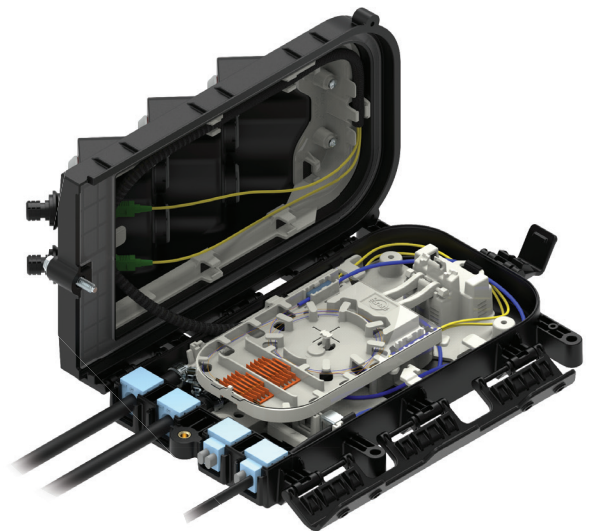

STP-L4T



Telcordia® is a registered trademark of Telcordia Technologies, Inc., now part of Ericsson.  
ROC™ is a registered trademark of Corning Incorporated.



## COYOTE® STP-LT CLOSURE KITS

Closure kits below are shown with **-XP**, where the **X** will be the number of OptiTaps® that should come pre-installed in the cover (up to 9 OptiTaps can be installed). If the requested value is 0-6, then the 6-Port Terminal Cover will be used. If the requested number is 7-9, then the 9-port Terminal Cover will be used. The remainder of the ports will be loaded with plugs. If you would like to use a 9-port cover with less than 7 OptiTaps, contact PLP.

### COYOTE STP-LT 3-Port Base Closure Kits

Catalog Number	Description
STP-L3T-XP-24-001	COYOTE STP-L Closure with 3-Port Base – Includes (1) Terminal Cover, (2) Small Conical Grommets 0.17" - 0.40" (4.3 - 10.2 mm), (2) Large Conical Grommets 0.40" - 0.55" (10.2 - 14 mm), (1) 12-Hole Drop Grommet 0.193 - 0.201" (4.9 - 5.1 mm), and (1) 24 Ct. Splice Tray
STP-L3T-XP-24-002	COYOTE STP-L Closure with 3-Port Base – Includes (1) Terminal Cover, (2) Small Conical Grommets 0.17" - 0.40" (4.3 - 10.2 mm), (2) Large Conical Grommets 0.40" - 0.55" (10.2 - 14 mm), (1) 6-Hole Flat Drop Grommet, and (1) 24 Ct. Splice Tray

All kits include (1) COYOTE STP-LT 3-Port Base Assembly with Universal Organizer, (1) Cover, (2) Grommet Kits, Cable Restraint Hardware, and SC/APC 2 mm Yellow Jacketed Pigtailed. Hanger Brackets are sold separately.

### COYOTE STP-LT 4-Port Base Closure Kits

Catalog Number	Description
STP-L4T-XP-24-001	COYOTE STP-L Closure with 4-Port Base – Includes (1) Terminal Cover, (2) Small Conical Grommets 0.17" - 0.40" (4.3 - 10.2 mm), (2) Large Conical Grommets 0.40" - 0.55" (10.2 - 14 mm), and (1) 24 Ct. Splice Tray
STP-L4T-XP-24-002	COYOTE STP-L Closure with 4-Port Base – Includes (1) Terminal Cover, (2) Small Conical Grommets 0.17" - 0.40" (4.3 - 10.2 mm), (2) Large Conical Grommets 0.40" - 0.55" (10.2 - 14 mm), (2) 2-Hole Flat Drop Grommets, and (1) 24 Ct. Splice Tray
STP-L4T-XP-24-003	COYOTE STP-L Closure with 4-Port Base – Includes (1) Terminal Cover, (2) Small Conical Grommets 0.17" - 0.40" (4.3 - 10.2 mm), (2) Large Conical Grommets 0.40" - 0.55" (10.2 - 14 mm), (2) 2-Hole ROC™ Drop Grommets, and (1) 24 Ct. Splice Tray

All kits include (1) COYOTE STP-L 4-Port Base Assembly with Universal Organizer, (1) Cover, Grommet Kit(s), Cable Restraint Hardware and SC/APC 2mm Yellow Jacketed Pigtailed. Hanger Brackets are sold separately.  
ROC™ Drop Cables are for Dielectric Drop Cables ONLY.

## COYOTE® STP-XLT

### Specifications

Catalog Number	STP-XL6T-XP-48-001 through STP-XL8T-XP-96-003
Cable Ports <sup>1</sup>	6 or 8
Cable Diameters	0.170" - 0.550" (4.3 - 14 mm), Round, Flat, and ROC™ Drop Cables
Configuration	Butt
Application	Direct Buried, Below Grade, Pole/Wall, and Aerial
Ingress Protection	In accordance to Telcordia® GR-771-CORE, Buried, Underground; IP-68
Size	11.8" L x 7.8" W x 6.2" H <sup>2</sup> (300 mm x 198 mm x 158 mm)

<sup>1</sup> Multi-hole grommets allow for more than one cable to enter each cable port.

<sup>2</sup> Outermost part of the assembly; using a shallow cover and terminal cover.

### STP-XLT BASE OPTIONS

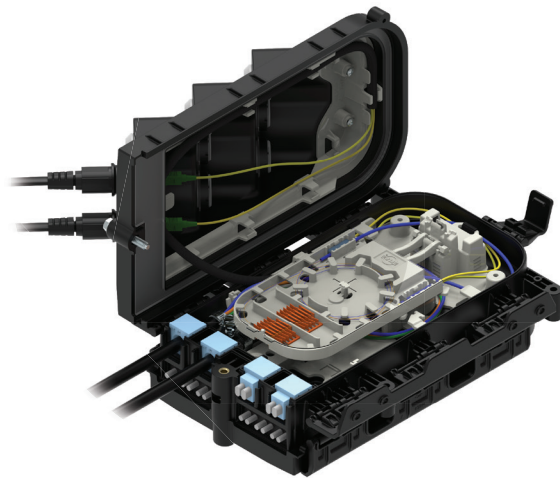

STP-XL6T

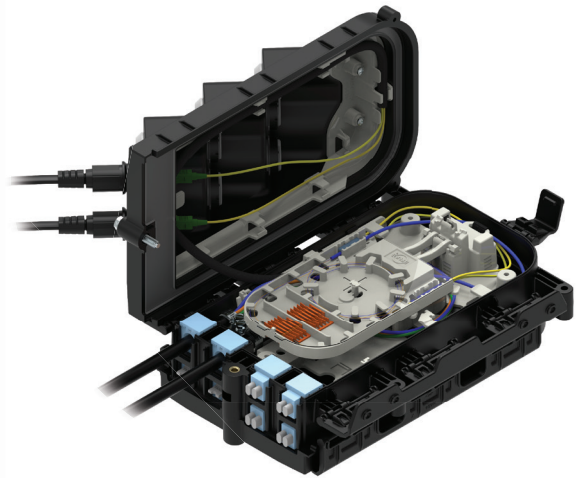

STP-XL8T

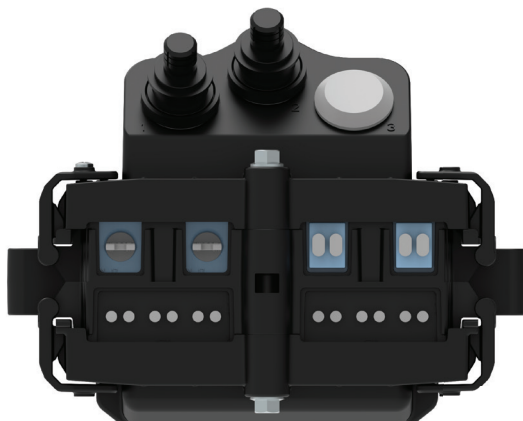



## COYOTE® STP-XLT CLOSURE KITS

Closure kits below are shown with **-XP**, where the **X** will be the number of OptiTaps® that should come pre-installed in the cover (up to 9 OptiTaps can be installed). If the requested value is 1-6, then the 6-Port Terminal Cover will be used. If the requested number is 7-9, then the 9-port Terminal Cover will be used. The remainder of the ports will be loaded with plugs. If you would like to use a 9-port cover with less than 7 OptiTaps contact PLP.

### COYOTE STP-XLT 6-Port Base Closure Kits

Catalog Number	Description
STP-XL6T-XP-48-001	COYOTE STP-XL Closure with 6-Port Base – Includes (1) Terminal Cover, (1) Shallow Cover, (4) Small Conical Grommets 0.17" - 0.40" (4.3 - 10.2 mm), (2) Large Conical Grommets 0.40" - 0.55" (10.2 - 14 mm), (2) 12-Hole Drop Grommets 0.193" - 0.201" (4.9 - 5.1 mm), and (2) 24 CT. Splice Trays
STP-XL6T-XP-48-002	COYOTE STP-XL Closure with 6-Port Base – Includes (1) Terminal Cover, (1) Shallow Cover, (4) Small Conical Grommets 0.17" - 0.40" (4.3 - 10.2 mm), (2) Large Conical Grommets 0.40" - 0.55" (10.2 - 14 mm), (2) 6-Hole Flat Drop Grommets, and (2) 24 CT. Splice Trays
STP-XL6T-XP-96-001	COYOTE STP-XL Closure with 6-Port Base – Includes (1) Terminal Cover, (1) Deep Cover, (4) Small Conical Grommets 0.17" - 0.40" (4.3 - 10.2 mm), (2) Large Conical Grommets 0.40" - 0.55" (10.2 - 14 mm), (2) 12-Hole Drop Grommets 0.193" - 0.201" (4.9 - 5.1 mm), and (4) 24 CT. Splice Trays
STP-XL6T-XP-96-002	COYOTE STP-XL Closure with 6-Port Base – Includes (1) Terminal Cover, (1) Deep Cover, (4) Small Conical Grommets 0.17" - 0.40" (4.3 - 10.2 mm), (2) Large Conical Grommets 0.40" - 0.55" (10.2 - 14 mm), (2) 6-Hole Flat Drop Grommets, and (4) 24 CT. Splice Trays

All kits include (1) COYOTE STP-XLT 6-Port Base Assembly with Universal Organizers, (2) Covers, (8) Grommets, Cable Restraint Hardware, and SC/APC 2 mm Yellow Jacketed Pigtailed. Hanger Brackets are sold separately.

### COYOTE STP-XLT 8-Port Base Closure Kits

Catalog Number	Description
STP-XL8T-XP-48-002	COYOTE STP-XL Closure with 8-Port Base – Includes (1) Terminal Cover, (1) Shallow Cover, (4) Small Conical Grommets 0.17" - 0.40" (4.3 - 10.2 mm), (2) Large Conical Grommets 0.40" - 0.55" (10.2 - 14 mm), (4) 2-Hole Flat Drop Grommets, and (2) 24 CT. Splice Trays
STP-XL8T-XP-48-003	COYOTE STP-XL Closure with 8-Port Base – Includes (1) Terminal Cover, (1) Shallow Cover, (4) Small Conical Grommets 0.17" - 0.40" (4.3 - 10.2 mm), (2) Large Conical Grommets 0.40" - 0.55" (10.2 - 14mm), (4) 2-Hole ROC Drop Grommets, and (2) 24 CT. Splice Trays
STP-XL8T-XP-96-002	COYOTE STP-XL Closure with 8-Port Base – Includes (1) Terminal Cover, (1) Deep Cover, (4) Small Conical Grommets 0.17" - 0.40" (4.3 - 10.2 mm), (2) Large Conical Grommets 0.40" - 0.55" (10.2 - 14 mm), (4) 2-Hole Flat Drop Grommets, and (4) 24 CT. Splice Trays
STP-XL8T-XP-96-003	COYOTE STP-XL Closure with 8-Port Base – Includes (1) Terminal Cover, (1) Deep Cover, (4) Small Conical Grommets 0.17" - 0.40" (4.3 - 10.2 mm), (2) Large Conical Grommets 0.40" - 0.55" (10.2 - 14 mm), (4) 2-Hole ROC™ Drop Grommets, and (4) 24 CT. Splice Trays

All kits include (1) COYOTE STP-XL 8-Port Base Assembly with Universal Organizers, (2) Covers, (10) Grommets, Cable Restraint Hardware, and SC/APC 2 mm Yellow Jacketed Pigtailed. Hanger Brackets are sold separately.

ROC™ Drop Cables are for Dielectric Drop Cables ONLY.

## COYOTE® STP PRO SERIES ACCESSORIES

### Accessory Kits for COYOTE STP Pro Series

Catalog Number	Description
STPXL-TK-002	Splice Tray Kit – Includes (1) Splice Tray, (1) Cover, (2) 12 CT. Single Fusion Splice Blocks, (2) LITE-GRIP® Retention Sleeves for Microtube, (2) LITE-GRIP Retention Sleeves for Buffer Tubes, (2) LITE-GRIP Retention Sleeves for Micro Buffer Tubes, (1) Felt Strip, and (12) Cable Ties
STPXL-EK-001	Splice Tray Extension Kit – Includes (1) Deep Cover, and (1) Expansion Piece
80813747	Deep Cover Kit - Includes (1) Deep Cover and Silicone Lubricant
8004153	Splice Block Kit - Includes (6) 48 CT. Mass Fusion or Splitter Splice Blocks, Mustard
80814575	Cover Tether Kit

## COYOTE® STP PRO TERMINAL CLOSURE ACCESSORIES

### Terminal Accessory Kits for COYOTE STP Pro Series

Catalog Number	Description
8003993	Heat Shrink Splice Protector Kit – Includes (12) 40 mm Mass Fusion
80808187	Heat Shrink Splice Protector Kit – Includes (12) 40 mm Single Fusion
8003509	Heat Shrink Splice Protector Kit – Includes (12) 60 mm Single Fusion
80807972	Hardened Adapter Installation Tool
8003715	OptiTap® Adapter Kit – Includes (1) OptiTap Adapter and (1) Installation Tool
8004115	Bulk Pack of OptiTap Adapters – Includes (10) OptiTap Adapters
8003724	Port Plug Kit – Includes (1) Port Plug and (1) Installation Tool
8004060	Bulk Pack of Port Plugs – Includes (10) Port Plugs
COYTRM-2PK-SCA-SB	Pigtail Kit - Includes (2) SC/APC 2 mm Jacketed Pigtails with Short Boot Connectors
COYTRM-3PK-SCA-SB	Pigtail Kit - Includes (3) SC/APC 2 mm Jacketed Pigtails with Short Boot Connectors
COYTRM-4PK-SCA-SB	Pigtail Kit - Includes (4) SC/APC 2 mm Jacketed Pigtails with Short Boot Connectors



OptiTap Adapter



Hardened Adapter  
Installation Tool

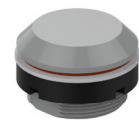

Port Plug

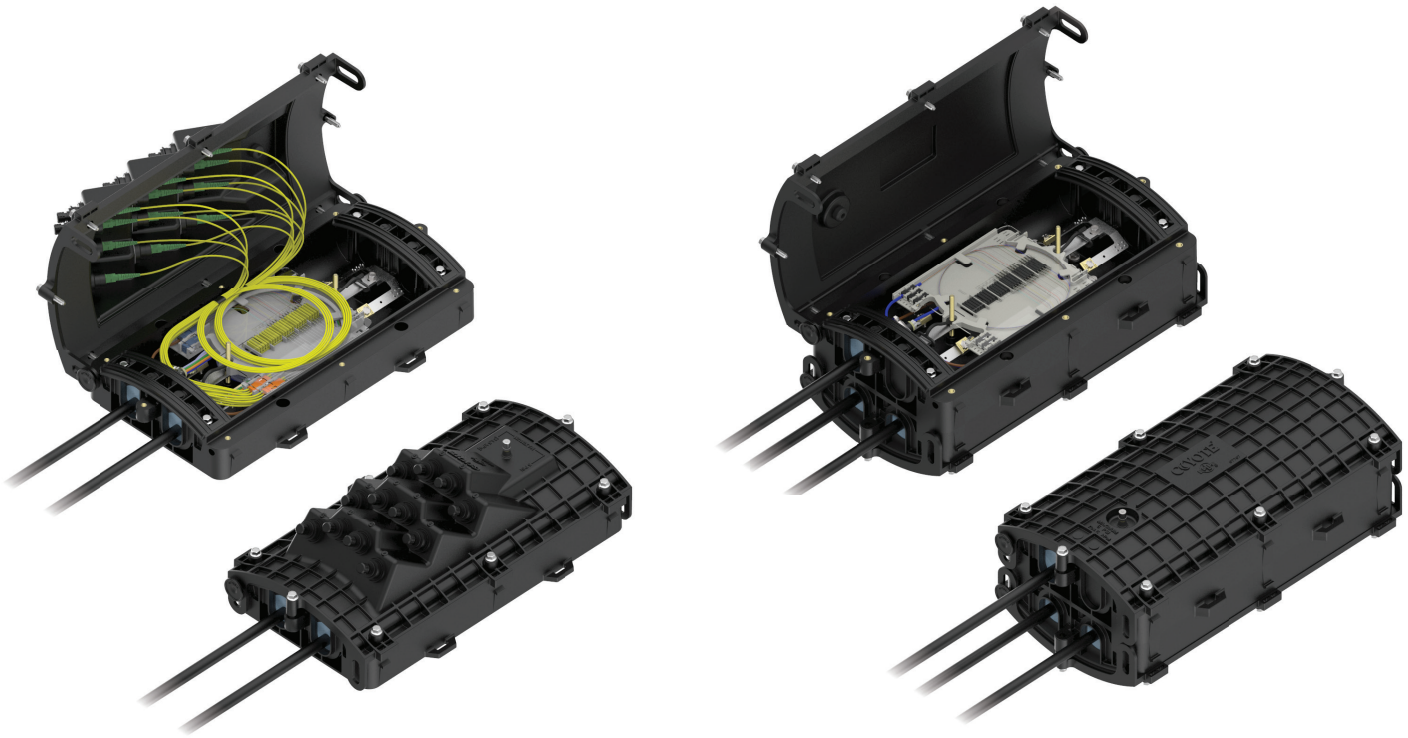

## COYOTE® TERMINAL CLOSURE SINGLE AND DUAL CHAMBER

The **COYOTE Terminal Closure** is the ideal choice for network designs that can be adapted as your network grows. Externally mounted OptiTap® hardened adapters allow for future installation of drops without closure re-entry. Additional drop capacity can be achieved through cable entry ports in the closure base, providing additional flexibility to support closures deeper in your network. The patented dual chamber design provides two distinct chambers that can be configured differently. A sealed window designed within the dual chamber allows fiber to be passed between chambers. The COYOTE Terminal Closure family is the adaptable choice for today's networks, where change is the only constant.

### FEATURES AND BENEFITS

- Available in 4, 8, or 12-Port OptiTap covers
- Designed to permit field installation and removal of hardened adapters
- Provided with SC/APC pigtail kits
- Internal organizer manages buffer tube or ribbon
- Flexible grommet sealing technology supports a wide range of flat and round cable profiles
- Flame-retardant kits available
- Designed and tested in accordance with Telcordia® GR-771-CORE Buried, Underground, IP-68 Rated Requirements

## COYOTE® SINGLE CHAMBER TERMINAL CLOSURE

### Specifications

<b>Catalog Number</b>	<b>800012002, 8006993, 8006953, 8006954, 8006955, 800012003, 80061067</b>
Splice Capacity (Maximum) – Single Fusion (Low Profile, 80809958), Single Fusion (Low Profile, 80813152), Single Fusion (Deep Profile, 80808945), Mass Fusion (Deep Profile, LGSTR144)	96, 144, 80, 288
Number of Splice Trays – 80809958, 80813152, 80808945, LGSTR144	4, 4, 2, 2
Cable Ports <sup>1</sup>	4 (2 at each end)
Cable Diameters	0.093" – 1.20" (2.4 – 30.5 mm) and Flat Drop
Adapter Quantity (Maximum)	12
Configuration	In-Line or Butt
Application	Direct Bury, Below Grade, Pole/Wall, Aerial
Ingress Protection	In accordance with Telcordia® GR-771-CORE, Buried, Underground; IP-68
Size <sup>2</sup>	18.7" L x 10.0" W x 5.1" H (475 x 254 x 130 mm)

<sup>1</sup> Multi-hole grommets allow for more than one cable to enter each cable port.

<sup>2</sup> Outermost part of the assembly; includes the hardened adapters

### COYOTE Single Chamber Terminal Kit Contents

Catalog Number	Description	Cover		
		Cover Type	Adapter Quantity	Plug Quantity
800012002	COYOTE Single Chamber Terminal Closure Includes – 2 OptiTap® Adapters	4-Port	2	2
8006993	COYOTE Single Chamber Terminal Closure Includes – 3 OptiTap Adapters	4-Port	3	1
8006953	COYOTE Single Chamber Terminal Closure Includes – 4 OptiTap Adapters	4-Port	4	0
8006954	COYOTE Single Chamber Terminal Closure Includes – 6 OptiTap Adapters	8-Port	6	2
8006955	COYOTE Single Chamber Terminal Closure Includes – 8 OptiTap Adapters	8-Port	8	0
800012003	COYOTE Single Chamber Terminal Closure Includes – 9 OptiTap Adapters	12-Port	9	3
80061067	COYOTE Single Chamber Terminal Closure Includes – 12 OptiTap Adapters	12-Port	12	0

All kits include (1) Closure Assembly, (2) 1-Hole Grommets 0.40" – 0.60" (10.2 – 15.2 mm), (1) 2-Hole Grommet 0.42" – 0.60" (10.7 – 15.2 mm), (1) 4-Hole Grommet 0.30" – 0.43" (7.6 – 10.9 mm), (1) Splice Tray (Cat. No. 80808945), Pigtailed and Cable Restraint Hardware



6-Port COYOTE Single Chamber Terminal Closure  
Catalog Number: 8006954



9-Port COYOTE Single Chamber Terminal Closure  
Catalog Number: 800012003



12-Port COYOTE Single Chamber Terminal Closure  
Catalog Number: 80061067



## COYOTE® DUAL CHAMBER TERMINAL CLOSURE

### Specifications

<b>Catalog Number</b>	<b>80061029, 800011830, 8006991, 800012140, 800012605, 800011839, 8006956</b>
Splice Capacity (Maximum) – Single Fusion (Low Profile, 80809958), Single Fusion (Low Profile, 80813152), Single Fusion (Deep Profile, 80808945), Mass Fusion (Deep Profile, LGSTR144)	192, 288, 160, 576
Number of Splice Trays – 80809958, 80813152, 80808945, LGSTR144	8, 8, 4, 4
Cable Ports <sup>1</sup>	8 (4 at each end)
Cable Diameters	0.093" – 1.20" (2.4 – 30.5 mm) and Flat Drop
Adapter Quantity (Maximum)	24
Configuration	In-Line or Butt
Application	Direct Bury, Below Grade, Pole/Wall, Aerial
Ingress Protection	In accordance with Telcordia® GR-771-CORE, Buried, Underground; IP-68
Size <sup>2</sup>	18.7" L x 10.0" W x 10.3" H (475 x 254 x 262 mm)

<sup>1</sup> Multi-hole grommets allow for more than one cable to enter each cable port.

<sup>2</sup> Outermost part of the assembly; includes the hardened adapters

### COYOTE Dual Chamber Terminal Kit Contents

Catalog Number	Description	Cover 1			Cover 2		
		Cover Type	Adapter Quantity	Plug Quantity	Cover Type	Adapter Quantity	Plug Quantity
80061029	COYOTE Dual Chamber Terminal Closure Includes – 6 OptiTap® Adapters	8-Port	6	2	Standard	N/A	
800011830	COYOTE Dual Chamber Terminal Closure Includes – 12 OptiTap Adapters	8-Port	6	2	8-Port	6	2
8006991	COYOTE Dual Chamber Terminal Closure Includes – 8 OptiTap Adapters	8-Port	8	0	Standard	N/A	
800012140	COYOTE Dual Chamber Terminal Closure Includes – 9 OptiTap Adapters	12-Port	9	3	Standard	N/A	
800012605	COYOTE Dual Chamber Terminal Closure Includes – 24 OptiTap Adapters	12-Port	12	0	12-Port	12	0
800011839	COYOTE Dual Chamber Terminal Closure for Direct Splice Applications	Standard	N/A		Standard	N/A	
8006956	COYOTE Dual Chamber Terminal Closure with Internal Bulkhead with 6 SC/APC Adapters	Standard	N/A		Standard	N/A	

All kits include (1) Closure Assembly, (2) 1-Hole Grommets 0.40" – 0.60" (10.2 – 15.2 mm), (1) 2-Hole Grommet 0.42" – 0.60" (10.7 – 15.2 mm), (1) 4-Hole Grommet 0.30" – 0.43" (7.6 – 10.9 mm), (1) Splice Tray (Cat. No. 80808945), Pigtails and Cable Restraint Hardware



9-Port COYOTE Dual Chamber Terminal Closure  
Catalog Number: 800012140



24-Port COYOTE Dual Chamber Terminal Closure  
Catalog Number: 800012605



Direct Splice or Cross-Connect COYOTE Dual Chamber Terminal Closure  
Catalog Number: 800011839 or 8006956

## ACCESSORIES AND MOUNTING BRACKETS

### COYOTE Terminal Closure Accessories

Catalog Number	Description
80809958	Splice Tray, COYOTE LITE-GRIP® Short, Low Profile, 24 CT., Single Fusion
80813152	Splice Tray, COYOTE LITE-GRIP Short, Low Profile, 36 CT., Single Fusion
80808945	Splice Tray, COYOTE LITE-GRIP Short, Deep Profile, 40 CT., Single Fusion
LGSTR144	Splice Tray, COYOTE LITE-GRIP Short, Deep Profile, 144 CT., Mass Fusion
80814649	Splice Tray, COYOTE LITE-GRIP® Short, Deep Profile 48 CT., Single Fusion, 144 CT., Mass Fusion
8003993	Heat Shrink Splice Protector Kit – Includes (12) 40 mm Mass Fusion
80808187	Heat Shrink Splice Protector Kit – Includes (12) 40 mm Single Fusion
8003509	Heat Shrink Splice Protector Kit – Includes (12) 60 mm Single Fusion
80807972	Hardened Adapter Installation Tool
8003715	OptiTap® Adapter Kit – Includes (1) OptiTap Adapter and (1) Installation Tool
8004115	Bulk Pack of OptiTap Adapters – Includes (10) OptiTap Adapters
8003724	Plug Kit – Includes (1) Plug and (1) Installation Tool
8004060	Bulk Pack of Plugs – Includes (10) Plugs
COYTRM-2PK-SCA	Pigtail Kit – Includes (2) SC/APC Pigtails
COYTRM-3PK-SCA	Pigtail Kit – Includes (3) SC/APC Pigtails
COYTRM-4PK-SCA	Pigtail Kit – Includes (4) SC/APC Pigtails

### COYOTE Terminal Single Chamber Mounting Brackets

Catalog Number	Description
8003797	Aerial Mounting Bracket – Strand Applications
8004179	Horizontal Aerial Mounting Bracket – Strand Applications
8003864	Aerial Mounting Bracket – ADSS Applications
8003703	Pole/Wall Mounting Bracket
8003835	Universal Mounting Bracket – Handhole Applications
8003706	Swing Arm Mounting Bracket

### COYOTE Terminal Dual Chamber Mounting Brackets

Catalog Number	Description
8003705	Aerial Mounting Bracket – Strand Applications
8003703	Pole/Wall Mounting Bracket
8003706	Swing Arm Mounting Bracket



Hardened Adapter  
Installation Tool



OptiTap® Adapter

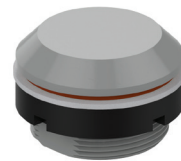

Plug

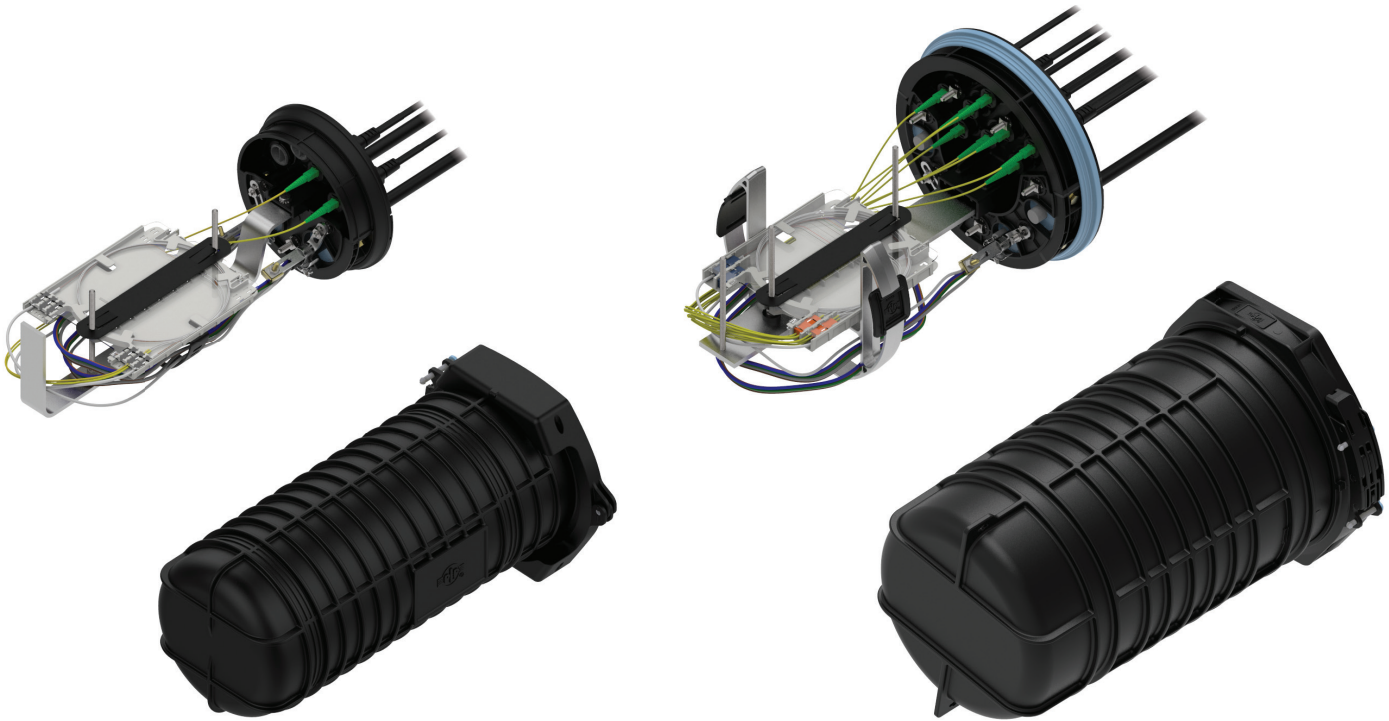

## COYOTE<sup>®</sup> TERMINAL DOME CLOSURE

### 6.5" AND 9.5"

The **COYOTE Terminal Dome Closure** offers four length options of 17", 22", 19", and 28" to support either buffer tube or ribbon fiber applications. These closures utilize PLP's patented segmented end plate design, which allows for easy installation of a variety of cable sizes in conjunction with the grommets. This segmented end plate design is ideal for supporting rural broadband networks. Each COYOTE Terminal Dome Closure contains externally mounted OptiTap<sup>®</sup> hardened adapters to support customer drop connections without entering the closure.

### FEATURES AND BENEFITS

- 2 and 4-Port segmented end plate designs provide independent access to each cable port without disrupting surrounding cables
- Up to 4 and 8 OptiTap connections on the 6.5" and 9.5" end plates
- Designed to permit field installation and removal of hardened adapters
- Provided with SC/APC pigtail kits
- Flexible grommet sealing technology supports a wide range of flat and round cable profiles
- Designed and tested in accordance with Telcordia<sup>®</sup> GR-771-CORE Buried, Underground, IP-68 Rated Requirements

# COYOTE® 6.5" X 17" AND 9.5" X 19" TERMINAL DOME CLOSURES

Specifications	6.5" x 17" Terminal Dome Closure		9.5" x 19" Terminal Dome Closure	
Catalog Number	Buffer Tube	Ribbon	Buffer Tube	Ribbon
Splice Capacity (Maximum) – Single Fusion (Low Profile, 80809958), Single Fusion (Low Profile, 80813152), Single Fusion (Deep Profile, 80808945), Ribbon (Deep Profile, LGSTR144)	144, 216, 120, N/A	96, 144, 80, 288	288, 432, 240, N/A	144, 216, 120, 432
Number of Splice Trays – 80809958, 80813152, 80808945, LGSTR144	6, 6, 3, N/A	4, 4, 2, 2	12, 12, 6, N/A	6, 6, 3, 3
Cable Ports <sup>1</sup>	2		4	
Cable Diameters	0.093" – 1.25" (2.4 – 31.8 mm) and Flat Drop		0.093" – 1.25" (2.4 – 31.8 mm) and Flat Drop	
Ground Studs	3		7	
Configuration	Butt		Butt	
Application	Direct Bury, Below Grade, Pole/Wall, Aerial		Direct Bury, Below Grade, Pole/Wall, Aerial	
Ingress Protection	In accordance with Telcordia® GR-771-CORE, Buried, Underground; IP-68		In accordance with Telcordia® GR-771-CORE, Buried, Underground; IP-68	
Size <sup>2</sup>	8.6" W x 17.9" L (218 x 463 mm)		13.3" W x 20.4" L (338 x 509 mm)	

<sup>1</sup> Multi-hole grommets allow for more than one cable to enter each cable port.

<sup>2</sup> Outermost part of the assembly; includes the sealing collar.

## ORGANIZER ASSEMBLIES

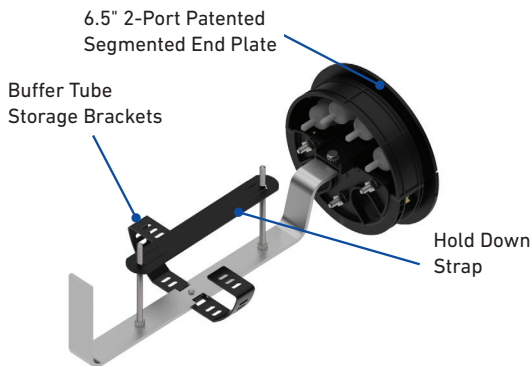

6.5" x 17" Terminal Dome Closure with 4 OptiTap® Adapters  
**Catalog Number: COYTD617B4-000**

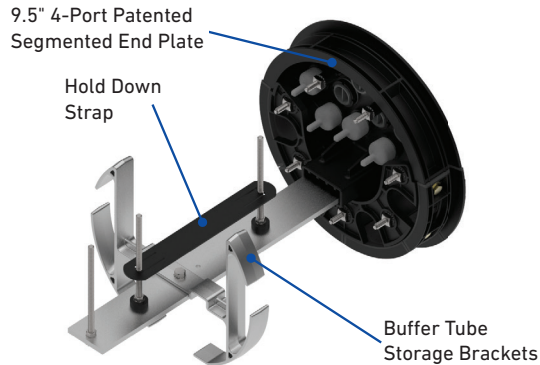

9.5" x 19" Terminal Dome Closure with 4 OptiTap Adapters  
**Catalog Number: COYTD919B4-000**

## COYOTE 6.5" x 17" and 9.5" x 19" Terminal Dome Kit Contents

Catalog Number	Description
COYTD617BX <sup>3</sup> -000	COYOTE 6.5" x 17" Terminal Dome Closure for Buffer Tube – Includes (2) 1-Hole Grommets 0.40" – 0.60" (10.2 – 15.2 mm) and (2) 1-Hole Grommets 0.60" – 0.85" (15.2 – 21.6 mm)
COYTD617RX <sup>3</sup> -000	COYOTE 6.5" x 17" Terminal Dome Closure for Ribbon – Includes (2) 1-Hole Grommets 0.40" – 0.60" (10.2 – 15.2 mm), (2) 1-Hole Grommets 0.60" – 0.85" (15.2 – 21.6 mm), (1) Transition Tubing Kit, and (2) Transport Tubing Kits
COYTD919BX <sup>3</sup> -000	COYOTE 9.5" x 19" Terminal Dome Closure for Buffer Tube – Includes (2) 2-Hole Grommets 0.42" – 0.60" (10.7 – 15.2 mm) and (2) 1-Hole Grommets 0.60" – 0.85" (15.2 – 21.6 mm)
COYTD919RX <sup>3</sup> -000	COYOTE 9.5" x 19" Terminal Dome Closure for Ribbon – Includes (2) 2-Hole Grommets 0.42" – 0.60" (10.7 – 15.2 mm), (2) 1-Hole Grommets 0.60" – 0.85" (15.2 – 21.6 mm), (1) Transition Tubing Kit, and (2) Transport Tubing Kits

All kits include (1) COYOTE End Plate Organizer, (1) Dome, (1) Gasket, (1) Collar, (4) Grommets, (1) Splice Tray (Cat. No. 80808945), Pigtails and Cable Restraint Hardware

<sup>3</sup> Number of adapters as determined by customer.

OptiTap® is a registered trademark of Corning Cable Systems.

Telcordia® is a registered trademark of Telcordia Technologies, Inc., now part of Ericsson.

CO-CA-1004-20



## COYOTE® 6.5" X 22" AND 9.5" X 28" TERMINAL DOME CLOSURE

### Specifications

Specifications	6.5" x 22" Terminal Dome Closure		9.5" x 28" Terminal Dome Closure	
	Buffer Tube	Ribbon	Buffer Tube	Ribbon
Splice Capacity (Maximum) – Single Fusion (Standard Profile, 80810086), Single Fusion (Deep Profile, LGSTS72), Ribbon (Deep Profile, LGSTR216)	144, 216, N/A	108, 144, 432	324, 432, N/A	180, 216, 648
Number of Splice Trays – 80810086, LGSTS72, LGSTR216	4, 3, N/A	3, 2, 2	9, 6, N/A	5, 3, 3
Cable Ports <sup>1</sup>	2		4	
Cable Diameters	0.093" – 1.25" (2.4 – 31.8 mm) and Flat Drop		0.093" – 1.25" (2.4 – 31.8 mm) and Flat Drop	
Ground Studs	3		7	
Configuration	Butt		Butt	
Application	Direct Bury, Below Grade, Pole/Wall, Aerial		Direct Bury, Below Grade, Pole/Wall, Aerial	
Ingress Protection	In accordance with Telcordia® GR-771-CORE, Buried, Underground; IP-68		In accordance with Telcordia® GR-771-CORE, Buried, Underground; IP-68	
Size <sup>2</sup>	8.6" W x 22.6" L (218 x 574 mm)		13.3" W x 29.4" L (338 x 749 mm)	

<sup>1</sup> Multi-hole grommets allow for more than one cable to enter each cable port.

<sup>2</sup> Outermost part of the assembly; includes the sealing collar.

### ORGANIZER ASSEMBLIES

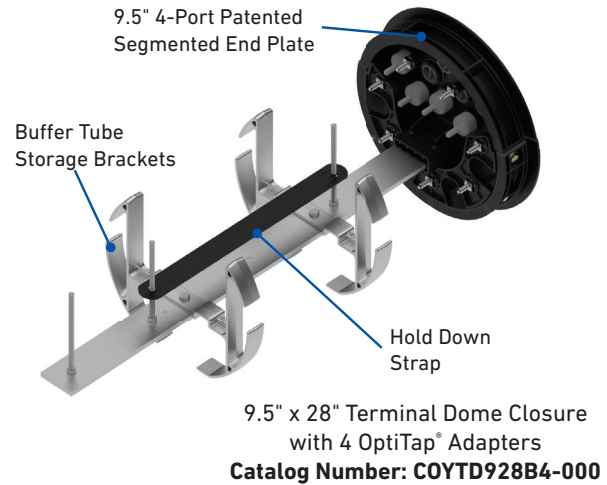
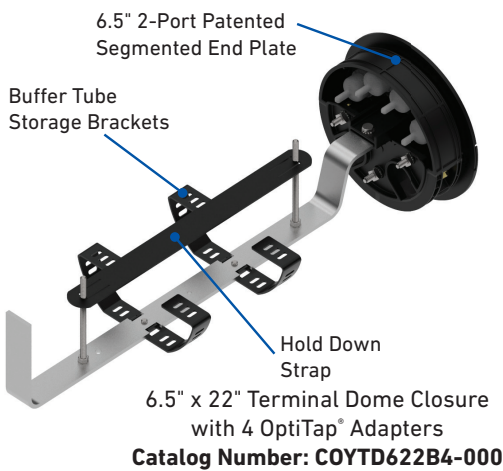

### COYOTE 6.5" x 22" and 9.5" x 28" Terminal Dome Kit Contents

Catalog Number	Description
COYTD622BX <sup>3</sup> -000	COYOTE 6.5" x 22" Terminal Dome Closure for Buffer Tube – Includes (2) 1-Hole Grommets 0.40" – 0.60" (10.2 – 15.2 mm) and (2) 1-Hole Grommets 0.60" – 0.85" (15.2 – 21.6 mm)
COYTD622RX <sup>3</sup> -000	COYOTE 6.5" x 22" Terminal Dome Closure for Ribbon – Includes (2) 1-Hole Grommets 0.40" – 0.60" (10.2 – 15.2 mm), (2) 1-Hole Grommets 0.60" – 0.85" (15.2 – 21.6 mm), (1) Transition Tubing Kit, and (2) Transport Tubing Kits
COYTD928BX <sup>3</sup> -000	COYOTE 9.5" x 28" Terminal Dome Closure for Buffer Tube – Includes (2) 2-Hole Grommets 0.42" – 0.60" (10.7 – 15.2 mm) and (2) 1-Hole Grommets 0.60" – 0.85" (15.2 – 21.6 mm)
COYTD928RX <sup>3</sup> -000	COYOTE 9.5" x 28" Terminal Dome Closure for Ribbon – Includes (2) 2-Hole Grommets 0.42" – 0.60" (10.7 – 15.2 mm), (2) 1-Hole Grommets 0.60" – 0.85" (15.2 – 21.6 mm), (1) Transition Tubing Kit, and (2) Transport Tubing Kits

All kits include (1) COYOTE End Plate Organizer, (1) Dome, (1) Gasket, (1) Collar, (4) Grommets, (1) Splice Tray (Cat. No. LGSTS72), Pigtailed and Cable Restraint Hardware

<sup>3</sup>Number of adapters as determined by customer.

OptiTap® is a registered trademark of Corning Cable Systems.  
Telcordia® is a registered trademark of Telcordia Technologies, Inc., now part of Ericsson.  
CO-CA-1004-20

## ORDERING INFORMATION

### COYOTE® Terminal Dome Closure Catalog Number

COYTD XXX X X -000  
 (Section 1) (Section 2) (Section 3)

Catalog Number Example: COYTD617B2-000

Section 1		Section 2		Section 3	
Size Selection (Select 1)	Closure Size	Organizer Selection (Select 1)	Organizer Type	Adapter Quantity (Select 1)	Related Closure Size
617	6.5" x 17"	B	Buffer Tube Organizer	0, 2, 4	6.5" x 17"
622	6.5" x 22"	R	Ribbon Organizer	0, 2, 4	6.5" x 22"
919	9.5" x 19"			0, 2, 4, 6, 8	9.5" x 19"
928	9.5" x 28"			0, 2, 4, 6, 8	9.5" x 28"

## ADDING OR REPLACING OPTITAP® ADAPTERS

COYOTE Terminal Domes can be ordered with any number of OptiTap adapters and plugs. Additional hardened adapters can be ordered and added as needed. Remove the existing port plug using the installation tool and a can wrench. Add an OptiTap adapter or replace a damaged adapter and retighten with the installation tool.

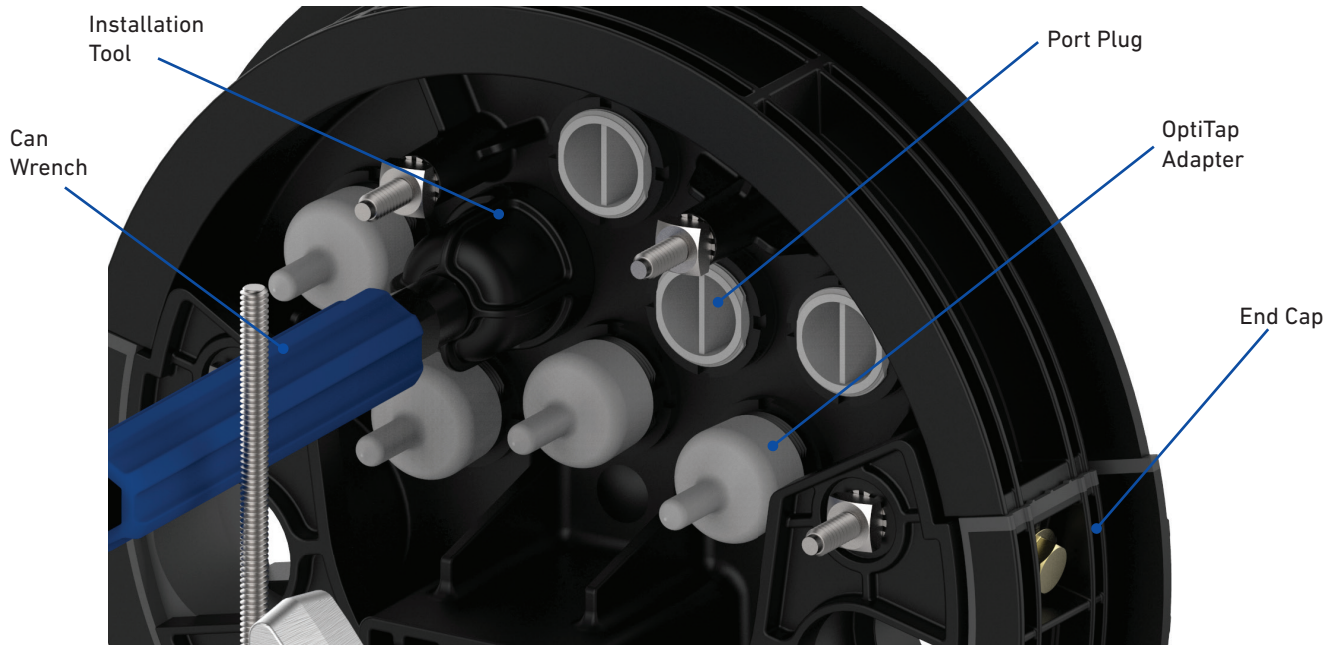



## ACCESSORIES



OptiTap® Adapter



Hardened Adapter  
Installation Tool

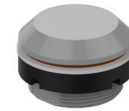

Port Plug

### COYOTE® Terminal Dome Closure Accessories

Catalog Number	Description
80809958	Splice Tray, COYOTE LITE-GRIP® Short, Low Profile, 24 CT., Single Fusion
80813152	Splice Tray, COYOTE LITE-GRIP Short, Low Profile, 36 CT., Single Fusion
80808945	Splice Tray, COYOTE LITE-GRIP Short, Deep Profile, 40 CT., Single Fusion
LGSTR144	Splice Tray, COYOTE LITE-GRIP Short, Deep Profile, 144 CT., Mass Fusion
80814649	Splice Tray, COYOTE LITE-GRIP Short, Deep Profile, 48 CT., Single Fusion, 144 CT., Mass Fusion
80810086	Splice Tray, COYOTE LITE-GRIP Long, Standard Profile, 36 CT., Single Fusion
LGSTS72	Splice Tray, COYOTE LITE-GRIP Long, Deep Profile, 72 CT., Single Fusion
LGSTR216	Splice Tray, COYOTE LITE-GRIP Long, Deep Profile, 216 CT., Mass Fusion
80814650	Splice Tray, COYOTE LITE-GRIP® Long, Deep Profile 96 CT., Single Fusion, 288 CT., Mass Fusion
8003993	Heat Shrink Splice Protector Kit – Includes (12) 40 mm Mass Fusion
80808187	Heat Shrink Splice Protector Kit – Includes (12) 40 mm Single Fusion
8003509	Heat Shrink Splice Protector Kit – Includes (12) 60 mm Single Fusion
COYEPFIX1	End Plate Assembly Fixture for 6.5" and 9.5" Domes
80807972	Hardened Adapter Installation Tool
8003715	OptiTap® Adapter Kit – Includes (1) OptiTap Adapter and (1) Installation Tool
8004115	Bulk Pack of OptiTap Adapters – Includes (10) OptiTap Adapters
8003724	Port Plug Kit – Includes (1) Port Plug and (1) Installation Tool
8004060	Bulk Pack of Port Plugs – Includes (10) Port Plugs
80809205	Strength Member Bracket Kit – Includes (2) Short L-Brackets
80808651	Strength Member Bracket Kit – Includes (4) Long L-Brackets
80808878	Large Strength Member Adapter Kit
80811037	4-Port Cable Retention Bobbin Kit
80811036	6-Port Drop Cable Retention Bobbin Kit
80812928	6/8-Port Drop Cable Retention Bobbin Kit
80808997	End Plate Gasket for 6.5" Domes
80807332	Latching Collar for 6.5" Domes
80061477	Latching Collar and End Plate Gasket for 9.5" Domes

## MOUNTING BRACKETS

### COYOTE 6.5" Dome Closure Mounting Brackets

Catalog Number	Description
8003831	Aerial Mounting Bracket – Strand Applications
8004035	Aerial Adjustable Offset Mounting Bracket – Strand Applications
8003833	Aerial Mounting Bracket – ADSS Applications
8004036	Aerial Adjustable Offset Mounting Bracket – ADSS Applications
8003702	Pole/Wall Mounting Bracket
8003835	Universal Mounting Bracket Kit for Handhole Applications
8003707	Swing Arm for Handhole Applications

### COYOTE 9.5" Dome Closure Mounting Brackets

Catalog Number	Description
8003940	Aerial Mounting Bracket – Strand Applications
8004037	Aerial Adjustable Offset Mounting Bracket – Strand Applications
8003869	Aerial Mounting Bracket – ADSS Applications
8004038	Aerial Adjustable Offset Mounting Bracket – ADSS Applications
8003942	Pole/Wall Mounting Bracket
8003835	Universal Mounting Bracket Kit for Handhole Applications
8003941	Aerial Mounting Bracket – End Plate Mounting Applications
8004003	Manhole Support



6.5" Dome Pole/Wall Mounting Bracket  
**Catalog Number: 8003702**

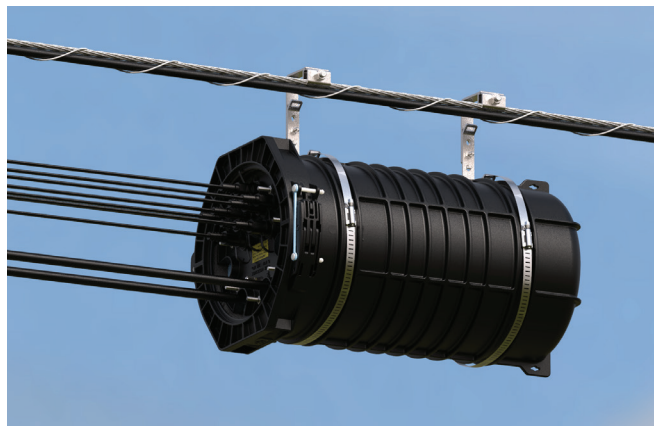

9.5" Aerial Adjustable Offset Mounting  
 Bracket for Strand Applications  
**Catalog Number: 8004037**





## SECTION 4 PEDESTALS

COYOTE® FIBER OPTIC SOLUTIONS

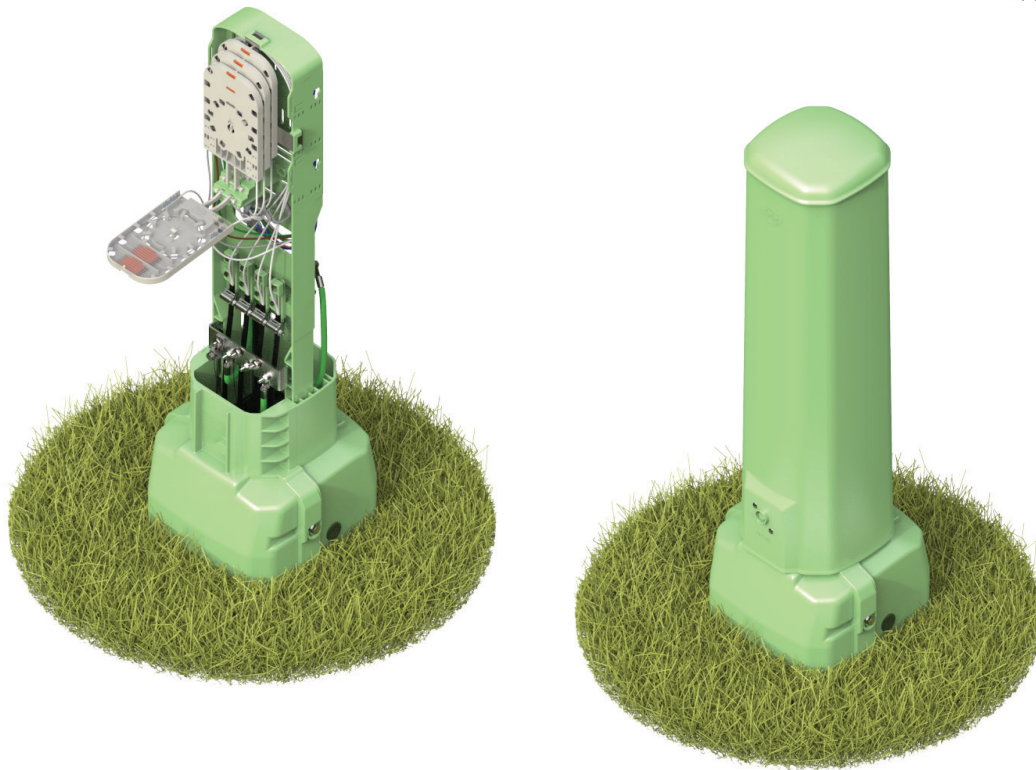

## COYOTE® PEDESTALS

**COYOTE Pedestals** provide easy customization options to adapt to your fiber or copper splicing needs at each location in your network. Each pedestal is pre-assembled and can be configured to accept fiber optic splice trays, fiber or copper terminals, fiber cross-connect bulkheads, or management brackets for copper splices. In addition, the organizer can be removed and a slotted metal back plane or metal frame can be inserted into the base to attach fiber closures and cabinets to provide additional protection for your splices. The versatility that COYOTE Pedestals provide allows you to create the network you desire.

### FEATURES AND BENEFITS

- Each pedestal size is pre-assembled with a base, automatic locking cover, and internal organizer with a grounding busbar
- Cover and base are manufactured out of a UV/FR stabilized material designed to withstand weathering
- Split base design enables easy installation around pre-installed duct/cables and simplifies replacement of existing pedestals
- Patented automatic cover locking system provides secure access without the need for additional hardware
- Grounding busbar isolates connections and is equipped with a ground wire terminal (#4 – #10)
- Supports a wide range of fiber and copper applications, including splicing, terminals, hardened connectivity, and cross-connects
- Organizer can accommodate COYOTE Flip Trays, LITE-GRIP® Splice Trays, or Legacy Splice Trays for maximum flexibility
- All fasteners are constructed of stainless steel to prohibit corrosion and can be secured or loosened with common tools (216 can wrench, 1/4" nut driver, or Philips screwdriver)
- Designed and tested in accordance with GR-13-CORE requirements

## COYOTE® 6" PEDESTAL ORGANIZER ASSEMBLIES

### With Universal Organizer

- Can be configured with COYOTE® Flip Trays
- Internal Cross-Connect or Hardened Connectivity Features for all splice tray configurations
- Ability to place hardened terminals; up to 4-Port Corning Evolv® Terminals
- Can place routing handles to properly store/waterfall copper splices

### With Metal Back Plane

- Accommodates most copper and fiber terminals
- Allows for ample space concerning fiber bend radius of MST/ Hardened Drops
- Can accommodate other distribution splice enclosures



COYOTE® 6" Pedestal,  
Universal Organizer w/  
Busbar and Split Base



COYOTE® 6" Pedestal,  
Metal Back Plane and  
Split Base

### COYOTE® 6" Pedestal Kits

Catalog Number	Description
COYPED6-UOS	COYOTE® 6" Pedestal, Universal Organizer <b>with Anchor Stake</b> – Includes (1) 6" Pedestal, Universal Organizer with Busbar and Split Base, (1) Dome, (1) Small Parts Bag, (1) Cable Retention Kit, and (1) 32" Anchor Stake with Attachment Hardware
COYPED6-UON	COYOTE® 6" Pedestal, Universal Organizer <b>without Anchor Stake</b> – Includes (1) 6" Pedestal, Universal Organizer with Busbar and Split Base, (1) Dome, (1) Small Parts Bag, and (1) Cable Retention Kit
COYPED6-MBPS	COYOTE® 6" Pedestal, Metal Back Plane <b>with Anchor Stake</b> – Includes (1) 6" Pedestal, Metal Back Plane and Split Base, (1) Dome, and (1) 32" Anchor Stake with Attachment Hardware
COYPED6-MBPN	COYOTE® 6" Pedestal, Metal Back Plane <b>without Anchor Stake</b> – Includes (1) 6" Pedestal, Metal Back Plane and Split Base, and (1) Dome

All kits include (1) COYOTE 6" Pedestal with Organizer, (1) Dome, and (1) Split Base. Anchor Stakes, Accessory Kits and Splice Trays Sold Separately.



# COYOTE® 8" PEDESTAL ORGANIZER ASSEMBLIES

## With Universal Organizer

- Can be configured with COYOTE® Flip Trays, LITE-GRIP® Splice Trays and Legacy Splice Trays
- Internal Cross-Connect or Hardened Connectivity Features for all splice tray configurations
- Ability to place hardened terminals; up to 8-Port Corning Evolv® Terminals
- Can place routing handles to properly store/waterfall copper splices

## With Metal Back Plane

- Accommodates most copper and fiber terminals
- Allows for ample space concerning fiber bend radius of MST/ Hardened Drops
- Can accommodate the COYOTE® PEDBOX® and other distribution splice enclosures

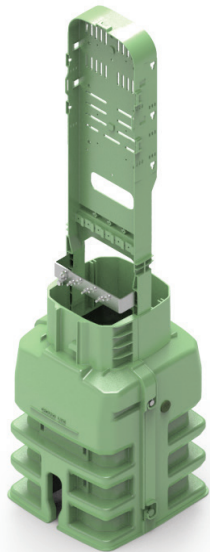

COYOTE® 8" Pedestal,  
Universal Organizer w/  
Busbar and Split Base

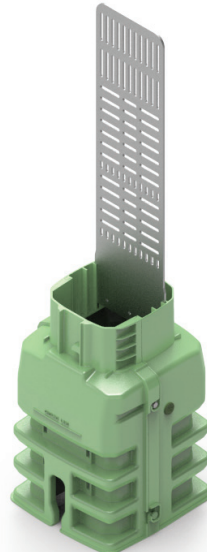

COYOTE® 8" Pedestal,  
Metal Back Plane and  
Split Base

## COYOTE® 8" Pedestal Kits

Catalog Number	Description
COYPED8-UOS	COYOTE® 8" Pedestal, Universal Organizer <b>with Anchor Stake</b> – Includes (1) 8" Pedestal, Universal Organizer with Busbar and Split Base, (1) Dome, (1) Small Parts Bag, (1) Cable Retention Kit, and (1) Anchor Stake with Attachment Hardware
COYPED8-UON	COYOTE® 8" Pedestal, Universal Organizer <b>without Anchor Stake</b> – Includes (1) 8" Pedestal, Universal Organizer with Busbar and Split Base, (1) Dome, (1) Small Parts Bag, and (1) Cable Retention Kit
COYPED8-MBPS	COYOTE® 8" Pedestal, Metal Back Plane <b>with Anchor Stake</b> – Includes (1) 8" Pedestal, Metal Back Plane and Split Base, (1) Dome, and (1) Anchor Stake with Attachment Hardware
COYPED8-MBPN	COYOTE® 8" Pedestal, Metal Back Plane <b>without Anchor Stake</b> – Includes (1) 8" Pedestal, Metal Back Plane and Split Base, and (1) Dome

All kits include (1) COYOTE 8" Pedestal with Organizer, (1) Dome, and (1) Split Base. Anchor Stakes, Accessory Kits and Splice Trays Sold Separately.

## COYOTE® 10" PEDESTAL ORGANIZER ASSEMBLIES

### With Universal Organizer

- Can be configured with COYOTE® Flip Trays, LITE-GRIP® Splice Trays and Legacy Splice Trays
- Internal Cross-Connect or Hardened Connectivity Features for all splice tray configurations
- Ability to place hardened terminals; up to 8-Port Corning Evolv® Terminals
- Can place routing handles to properly store/waterfall copper splices

### With Metal Frame

- Accommodates most copper and fiber terminals
- Allows for ample space concerning fiber bend radius of MST/ Hardened Drops
- Can accommodate the COYOTE® STP-L, STP-XL, PEDBOX®, and other distribution splice enclosures

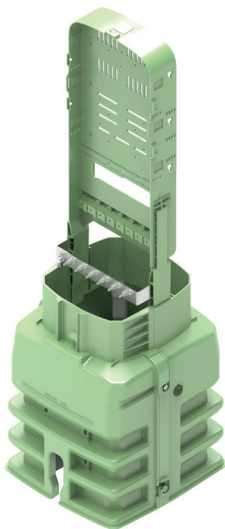

COYOTE® 10" Pedestal,  
Universal Organizer w/  
Busbar and Split Base

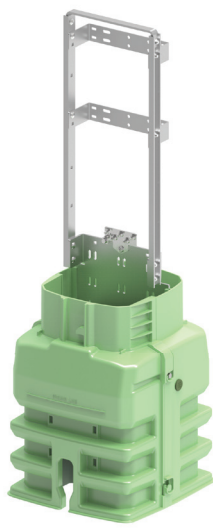

COYOTE® 10" Pedestal,  
Metal Frame w/ Dual Offset  
Brackets and Split Base

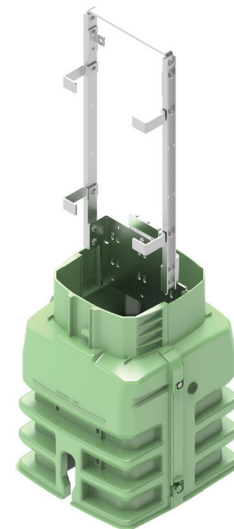

COYOTE® 10" Pedestal,  
Metal Frame w/ STP PRO  
Mounting Brackets and  
Split Base

### COYOTE® 10" Pedestal Kits

Catalog Number	Description
COYPED10-UOS	COYOTE® 10" Pedestal, Metal Frame with Dual Offset Brackets <b>with Anchor Stake</b> – Includes (1) 10" Pedestal, Metal Frame and Split Base, (1) Dome, and (1) Anchor Stake with Attachment Hardware
COYPED10-UON	COYOTE® 10" Pedestal, Metal Frame with Dual Offset Brackets <b>without Anchor Stake</b> – Includes (1) 10" Pedestal, Metal Frame and Split Base, and (1) Dome
COYPED10-MFDOS	COYOTE® 10" Pedestal, Metal Frame with Dual Offset Brackets <b>with Anchor Stake</b> – Includes (1) 10" Pedestal, Metal Frame and Split Base, (1) Dome, and (1) Anchor Stake with Attachment Hardware
COYPED10-MFDON	COYOTE® 10" Pedestal, Metal Frame with Dual Offset Brackets <b>without Anchor Stake</b> – Includes (1) 10" Pedestal, Metal Frame and Split Base, and (1) Dome
COYPED10-MFSTPS	COYOTE® 10" Pedestal, Metal Frame, STP Pro Series Brackets <b>with Anchor Stake</b> – Includes (1) 10" Pedestal, Metal Frame and Split Base, (1) Dome, (1) STP Pro Series Mounting Hardware Bag, and (1) Anchor Stake with Attachment Hardware
COYPED10-MFSTPN	COYOTE® 10" Pedestal, Metal Frame, STP Pro Series Brackets <b>without Anchor Stake</b> – Includes (1) 10" Pedestal, Metal Frame and Split Base, (1) Dome, and (1) STP Pro Series Mounting Hardware Bag

All kits include (1) COYOTE 10" Pedestal with Organizer, (1) Dome, and (1) Split Base. Anchor Stakes, Accessory Kits and Splice Trays Sold Separately.

Corning Evolv® Solution with Pushlok™ Technology is a registered trademark of Corning Cable Systems.

CO-CA-1004-20

## COYOTE® PEDESTAL SPLICING KITS

- Combines multiple different SKUs into one easy-to-order part number
- Simplifies storage and transportation of pedestal kits
- COYOTE® Pedestal Splicing Kits include: (1) COYOTE® Pedestal with Universal Organizer, (1) Splice Tray, (1) Tray Kit, and the option to include (1) Anchor Stake

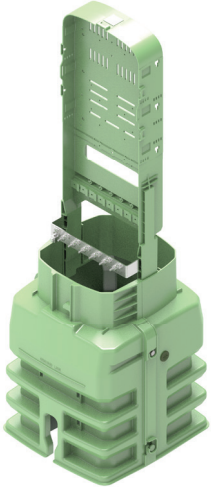

COYOTE Pedestal,  
Universal Organizer  
w/Busbar and Split Base

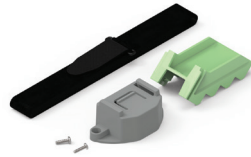

Tray Kit  
(Catalog Number:  
COYPED10-FLIPTK shown)

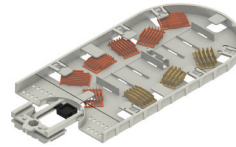

Splice Tray  
(Catalog Number:  
80814405 shown)

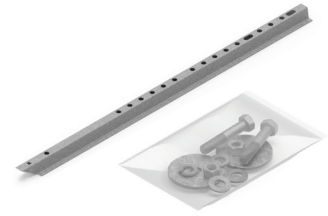

Anchor Stake Kit  
(Optional)

### COYOTE® 6" Pedestal Splicing Kits

Catalog Number	Description
COYPED6-UON-1-1	COYOTE 6" Pedestal with Universal Organizer and STPX-002 Splice Tray
COYPED6-UOS-1-1	COYOTE 6" Pedestal with Universal Organizer, STPX-002 Splice Tray, and Anchor Stake

### COYOTE® 8" Pedestal Splicing Kits

Catalog Number	Description
COYPED8-UON-1-1	COYOTE 8" Pedestal with Universal Organizer and 80813152 Splice Tray
COYPED8-UOS-1-1	COYOTE 8" Pedestal with Universal Organizer, 80813152 Splice Tray, and Anchor Stake
COYPED8-UON-2-1	COYOTE 8" Pedestal with Universal Organizer and 80808945 Splice Tray
COYPED8-UOS-2-1	COYOTE 8" Pedestal with Universal Organizer, 80808945 Splice Tray, and Anchor Stake
COYPED8-UON-3-1	COYOTE 8" Pedestal with Universal Organizer and 80814405 Flip Tray
COYPED8-UOS-3-1	COYOTE 8" Pedestal with Universal Organizer, 80814405 Flip Tray, and Anchor Stake

### COYOTE® 10" Pedestal Splicing Kits

Catalog Number	Description
COYPED10-UON-1-1	COYOTE 10" Pedestal with Universal Organizer and 80813152 Splice Tray
COYPED10-UOS-1-1	COYOTE 10" Pedestal with Universal Organizer, 80813152 Splice Tray, and Anchor Stake
COYPED10-UON-2-1	COYOTE 10" Pedestal with Universal Organizer and 80808945 Splice Tray
COYPED10-UOS-2-1	COYOTE 10" Pedestal with Universal Organizer, 80808945 Splice Tray, and Anchor Stake
COYPED10-UON-3-1	COYOTE 10" Pedestal with Universal Organizer and 80814405 Flip Tray
COYPED10-UOS-3-1	COYOTE 10" Pedestal with Universal Organizer, 80814405 Flip Tray, and Anchor Stake

## COYOTE® PEDESTAL FIBER SPLICING OPTIONS

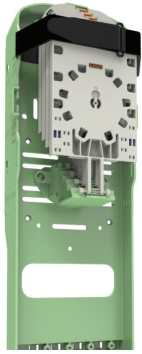

COYOTE® 6" Pedestal,  
Flip Tray Kit

**Catalog Number:**  
**COYPED6-FLIPTK**

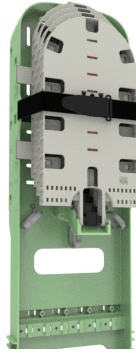

COYOTE 8" Pedestal,  
Flip Tray Kit

**Catalog Number:**  
**COYPED8-FLIPTK**

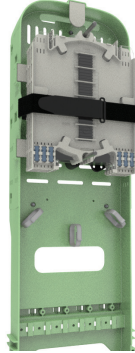

COYOTE 8" Pedestal,  
LITE-GRIP® Tray Kit

**Catalog Number:**  
**COYPED8-LGTK**

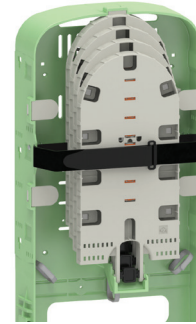

COYOTE 10" Pedestal,  
LITE-GRIP® Tray Kit

**Catalog Number:**  
**COYPED10-FLIPTK**

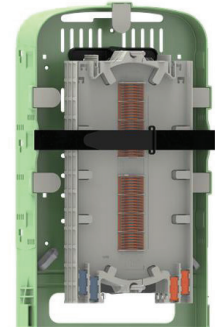

COYOTE 10" Pedestal,  
LITE-GRIP® Tray Kit

**Catalog Number:**  
**COYPED10-LGTK**

### Fiber Splicing - 6" Pedestal Flip Trays

Catalog Number	Description
COYPED6-FLIPTK	COYOTE Flip Tray, Kit, 6" Pedestal
STPXL-TK-002	Low Profile Single Fusion Flip Tray, 24 CT.

### Fiber Splicing - 8" Pedestal Flip Trays

Catalog Number	Description
COYPED8-FLIPTK	COYOTE Flip Tray, Kit, 8" Pedestal
80814405	Low Profile Flip Tray, 72 CT. Single Fusion or 144 CT. Mass Fusion
80814406	Deep Profile Flip Tray, 72 CT. Single Fusion or 288 CT. Mass Fusion

### Fiber Splicing - 8" Pedestal LITE-GRIP Trays

Catalog Number	Description
COYPED8-LGTK	LITE-GRIP Tray Kit, 8" Pedestal
80813152	Splice Tray, COYOTE LITE-GRIP Short, Low Profile, 36 CT. Single Fusion
80808945	Splice Tray, COYOTE LITE-GRIP Short, Deep Profile, 40 CT. Single Fusion
80814649	Splice Tray, COYOTE LITE-GRIP Short, Deep Profile, 48 CT. Single Fusion, 144 CT. Mass Fusion

### Fiber Splicing - 10" Pedestal Flip Trays

Catalog Number	Description
COYPED10-FLIPTK	COYOTE Flip Tray, Kit, 10" Pedestal
80814405	Low Profile Flip Tray, 72 CT. Single Fusion or 144 CT. Mass Fusion
80814406	Deep Profile Flip Tray, 72 CT. Single Fusion or 288 CT. Mass Fusion
80813238	Low Profile HD Flip Tray, 72 CT. Single Fusion or 288 CT. Mass Fusion

### Fiber Splicing - 10" Pedestal LITE-GRIP Trays

Catalog Number	Description
COYPED10-LGTK	LITE-GRIP Tray Kit, 10" Pedestal
80813152	Splice Tray, COYOTE LITE-GRIP Short, Low Profile, 36 CT. Single Fusion
80808945	Splice Tray, COYOTE LITE-GRIP Short, Deep Profile, 40 CT. Single Fusion
LGSTS72	Splice Tray, COYOTE LITE-GRIP Long, Deep Profile, 72 CT. Single Fusion
80814650	Splice Tray, COYOTE LITE-GRIP Long, Deep Profile, 96 CT. Single Fusion or 288 CT. Mass Fusion



## COYOTE® PEDESTAL CROSS-CONNECT ORGANIZER OPTIONS



COYOTE® Pedestal XC Bulkhead, 12-Port  
**Catalog Number:**  
COYPED-BLKHD12P



COYOTE® Pedestal XC Bulkhead, 24-Port  
**Catalog Number:**  
COYPED-BLKHD24P



COYOTE® 10" Pedestal, XC Bulkhead, 48-Port  
**Catalog Number:**  
COYPED10-BLKHD48P



COYOTE® 6" Pedestal, Internal Cross-Connect Kit  
**Catalog Number:**  
COYPED6-IXC

### Fiber Splicing and Patching - Adapter Bulkheads

Catalog Number	Description
COYPED-BLKHD12P	Adapter Bulkhead, 12-Port, All Pedestals
COYPED-BLKHD24P	Adapter Bulkhead, 24-Port, All Pedestals
COYPED10-BLKHD48P	Adapter Bulkhead, 48-Port, 10" Pedestal Only
80813988	Flangeless Adapter Kit – Includes (6) SC/APC Duplex Flangeless Adapters
80813989	Flangeless Adapter Kit – Includes (6) SC/UPC Duplex Flangeless Adapters
80813990	Flangeless Adapter Kit – Includes (6) LC/APC Quad Flangeless Adapters
80813991	Flangeless Adapter Kit – Includes (6) LC/UPC Quad Flangeless Adapters

### Fiber Splicing and Patching - Internal Cross-Connect Bulkheads

Catalog Number	Description
COYPED6-IXC	Internal Cross-Connect Bulkhead, 6" Pedestal
COYPED8-IXC	Internal Cross-Connect Bulkhead, 8" Pedestal
80813595	Adapter Kit – Includes (8) SC/APC Duplex Adapters
80813596	Adapter Kit – Includes (8) SC/UPC Duplex Adapters
80813599	Adapter Kit – Includes (8) LC/APC Quad Adapters
80813600	Adapter Kit – Includes (8) LC/UPC Quad Adapters

### COYOTE Pedestal Cross-Connect Accessories

Catalog Number	Description
COYTRM-2PK-SCA-SB	Pigtail Kit – Includes (2) SC/APC 2 mm Jacketed Pigtails with Short Boot Connectors
COYTRM-3PK-SCA-SB	Pigtail Kit – Includes (3) SC/APC 2 mm Jacketed Pigtails with Short Boot Connectors
COYTRM-4PK-SCA-SB	Pigtail Kit – Includes (4) SC/APC 2 mm Jacketed Pigtails with Short Boot Connectors
COYSP1X2SCA	COYOTE Pre-Connectorized Splitter - 1x2 SC/APC
COYSP1X4SCA	COYOTE Pre-Connectorized Splitter - 1x4 SC/APC
COYSP1X8SCA	COYOTE Pre-Connectorized Splitter - 1x8 SC/APC
COYSP1X16SCA	COYOTE Pre-Connectorized Splitter - 1x16 SC/APC

OptiTap® is a registered trademark of Corning Cable Systems.

## COYOTE® PEDESTAL ORGANIZER OPTIONS



COYOTE 10" Pedestal,  
OptiTap® Terminal  
Bulkhead

**Catalog Number:**  
**COYPED10-BLKHDTRM**

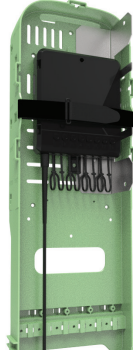

COYOTE 8" & 10"  
Pedestal, Terminal  
Mounting Kit

**Catalog Number:**  
**COYPED810-TM**



COYOTE 10" Pedestal,  
Expanded Buffer Tube  
Storage Brackets

**Catalog Number:**  
**COYPED10-EXBT**



COYOTE 8" Pedestal, Copper  
Routing Handle Kit

**Catalog Number:**  
**COYPED8-CWH**

### Hardened Connectivity - OptiTap® Terminal Bulkheads

Catalog Number	Description
COYPED6-BLKHDTRM	COYOTE 6" Pedestal OptiTap Terminal Bulkhead, 4-Port
COYPED8-BLKHDTRM	COYOTE 8" Pedestal OptiTap Terminal Bulkhead, 8-Port
COYPED10-BLKHDTRM	COYOTE 10" Pedestal OptiTap Terminal Bulkhead, 12-Port
80807972	Hardened Adapter Installation Tool
8003715	OptiTap® Adapter Kit – Includes (1) OptiTap Adapter and (1) Installation Tool
8004115	Bulk Pack of OptiTap Adapters – Includes (10) OptiTap Adapters

### Terminal Bracket

Catalog Number	Description
COYPED810-TM	Terminal Mounting Kit, 8" and 10" Pedestals

### Expanded Buffer Tube Storage Brackets

Catalog Number	Description
COYPED10-EXBT	Expanded Buffer Tube Storage Brackets, 10" Pedestal

### Copper Applications

Catalog Number	Description
COYPED6-CWH	Copper Waterfall Handle Kit, 6" Pedestal
COYPED8-CWH	Copper Waterfall Handle Kit, 8" Pedestal
COYPED10-CWH	Copper Waterfall Handle Kit, 10" Pedestal



## COYOTE® PEDESTAL REPLACEMENT KITS



Dome Replacement Kit

**Catalog Number:**  
**COYPED8-DOME**

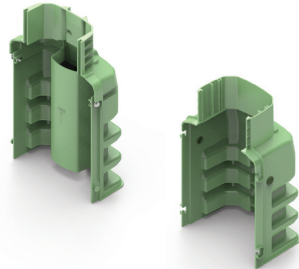

Base Replacement Kit

**Catalog Number:**  
**COYPED8-BASE**

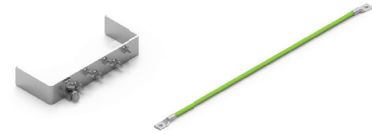

Ground Plate Kit

**Catalog Number:**  
**COYPED8-GRDPLT**

Catalog Number	Description
COYPED6-DOME	COYOTE 6" Dome Replacement Kit
COYPED8-DOME	COYOTE 8" Dome Replacement Kit
COYPED10-DOME	COYOTE 10" Dome Replacement Kit
COYPED6-BASE	COYOTE 6" Base Replacement Kit
COYPED8-BASE	COYOTE 8" Base Replacement Kit
COYPED10-BASE	COYOTE 10" Base Replacement Kit
COYPED6-GRDPLT	Grounding Plate Kit for 6" Pedestal – Includes (1) Ground Plate Assembly and (1) Bonding Braid
COYPED8-GRDPLT	Grounding Plate Kit for 8" Pedestal – Includes (1) Ground Plate Assembly and (1) Bonding Braid
COYPED10-GRDPLT	Grounding Plate Kit for 10" Pedestal – Includes (1) Ground Plate Assembly and (1) Bonding Braid

# COYOTE PEDESTAL ACCESSORIES

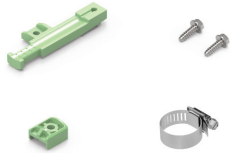

**Catalog Number:**  
**COYPED-CRB**  
Cable Restraint  
Bracket Kit  
Pack of 20

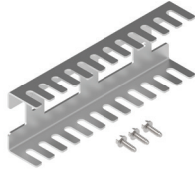

**Catalog Number:**  
**COYPED810-MD7**  
7 mm Microduct  
Bracket Kit  
For 8" and 10"  
Pedestals



**Catalog Number:**  
**COYPED-BNDBRD**  
Bonding Braid Kit  
Pack of 20



**Catalog Number:**  
**COYPED-GRDPLTEX**  
Ground Plate Extension Kit

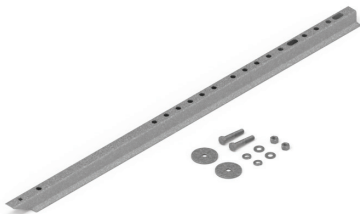

**Catalog Number:**  
**COYPED-AS42**  
42" Anchor Stake Kit



**Catalog Number:**  
**COYPED-FBRTAB**  
Fiber Retention Tab Kit  
Pack of 50



**Catalog Number:**  
**COYPED-FBRCLIP**  
Fiber Cable  
Management Clip Kit  
Pack of 10



**Catalog Number:**  
**COYPED-DRPGMT**  
Drop Port Grommet  
Pack of 20

Catalog Number	Description
COYPED-CRB	Cable Restraint Bracket Kit – Includes (20) Strength Member Brackets, (20) Strength Member Bracket Caps, (20) Hose Clamps, and (40) Hex Head Self-Tapping Screws
COYPED-DRPCHNL	Drop Channel Kit – Includes (1) Drop Channel and (1) Foam Plug
COYPED-BNDBRD	Bonding Braid Kit – Includes (20) Bonding Braids
COYPED-AS42	Anchor Stake Kit – Includes (1) 42" Anchor Stake and Mounting Hardware
COYPED-AS32	Anchor Stake Kit – Includes (1) 32" Anchor Stake and Mounting Hardware
COYPED-FBRTAB	Retention Tab Kit – Includes (50) Retention Tabs
COYPED-FBRCLIP	Fiber Cable Management Clip Kit – Includes (10) Fiber Routing Clips
COYPED-DRPGMT	Base Drop Grommet Kit – Includes (20) Base Drop Grommets
COYPED-GRDPLTEX	Grounding Plate Kit Extension Kit
COYPED6-MD5	6" Pedestal 5 mm Microduct Bracket Kit - Accepts (20) 5 mm Microducts
COYPED6-MD7	6" Pedestal 7 mm Microduct Bracket Kit - Accepts (20) 7 mm Microducts
COYPED810-MD5	8" and 10" Pedestals 5 mm Microduct Bracket Kit - Accepts (24) 5 mm Microducts
COYPED810-MD7	8" and 10" Pedestals 7 mm Microduct Bracket Kit - Accepts (24) 7 mm Microducts

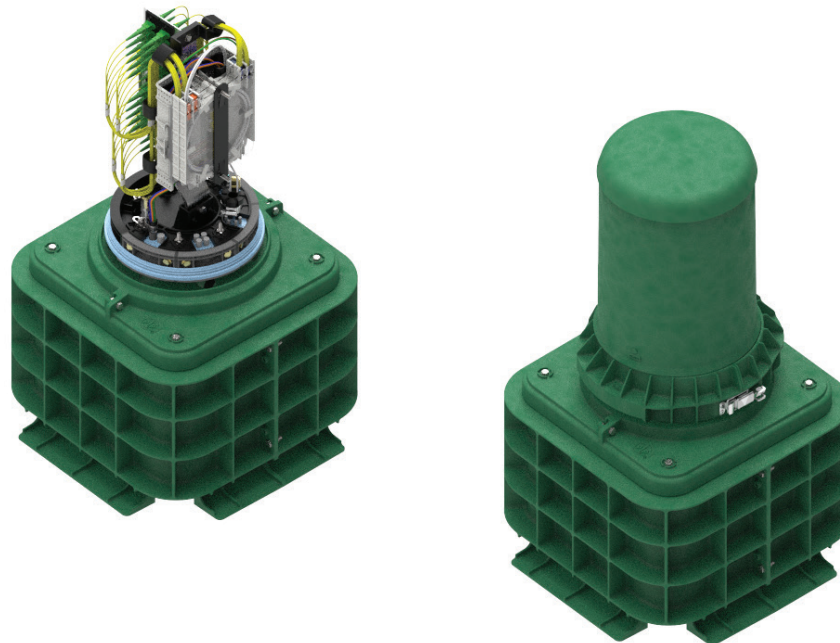

## COYOTE® GLC

### 9.5" X 17" AND 9.5" X 28"

The **COYOTE GLC (Ground Level Closure)** offers two length options of 17" and 28" to support either buffer tube or ribbon fiber applications. These closures utilize PLP's patented segmented end plate design, which allows for easy installation of a variety of cable sizes in conjunction with our grommets. The GLC is a hermetically sealed pedestal system that permits a high volume of uncut slack storage and its unique design doesn't force you to work where the closure is installed.

### FEATURES AND BENEFITS

- 4-Port segmented end plate design provides independent access to each cable port without disrupting surrounding cables
- Multiple tray designs support mass fusion splicing, single fusion splicing, or a combination of both
- Flexible grommet sealing technology supports a wide range of flat and round cable profiles
- Hermetically sealed dome eliminates potential for water intrusion and prevents invasion of insects
- Accessible isolated grounding system that allows ground testing to occur without entering the splice closure
- Slack storage of uncut cable allows dome closure to be carried to a splice truck or other suitable working environment
- The small GLC base with cover can be used for pedestrian applications (Tier 5)

# SPECIFICATIONS

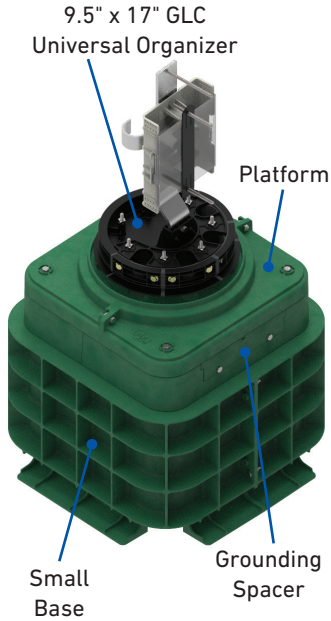

## COYOTE 9.5" x 17" GLC with Universal Organizer

<b>Catalog Numbers</b>		<b>COYGLC-F1-000, COYGLC-F1B-000, COYGLC-F1B-100</b>
Splice Capacity (Maximum) – Single Fusion (Low Profile, 80809958), Single Fusion (Low Profile, 80813152), Single Fusion (Deep Profile, 80808945), Mass Fusion (Deep Profile, LGSTR144)		96, 144, 80, 288
Number of Splice Trays – 80809958, 80813152, 80808945, LGSTR144		4, 4, 2, 2
Cable Ports <sup>1</sup>		4
Cable Diameters	Small Base	0.093" – 0.60" (2.4 – 15.2 mm) and Flat Drop
	Large Base	0.093" – 1.25" (2.4 – 31.8 mm) and Flat Drop
Ground Studs		4
Configuration		Butt
Cable Types		Buffer Tube or Ribbon
Application		Pedestal
Ingress Protection		In accordance with Telcordia® GR-771-CORE, Pedestal; IP-68
Size <sup>2</sup>		15.4" L x 15.4" W x 20.4" H (390 x 390 x 520 mm)
Kit Contents <sup>3</sup>	COYGLC-F1-000	Includes (1) Standard Platform
	COYGLC-F1B-000	Includes (1) Standard Platform and (1) Small Base
	COYGLC-F1B-100	Includes (1) Standard Platform, (1) Small Base, & (1) Grounding Spacer Kit

<sup>1</sup> Multi-hole grommets allow for more than one cable to enter each cable port

<sup>2</sup> Includes platform, collar, and dome assembly only. See COYOTE GLC Bases for base sizes

<sup>3</sup> All kits include (1) Green GLC Dome, (1) COYOTE 9.5" End Plate with Organizer, (1) Gasket, (1) Collar, (2) 2-Hole Grommets, (1) 4-Hole Grommet, (1) 6-Hole Grommet, (1) Splice Tray (Catalog Number: 80808945) and Cable Restraint Hardware.

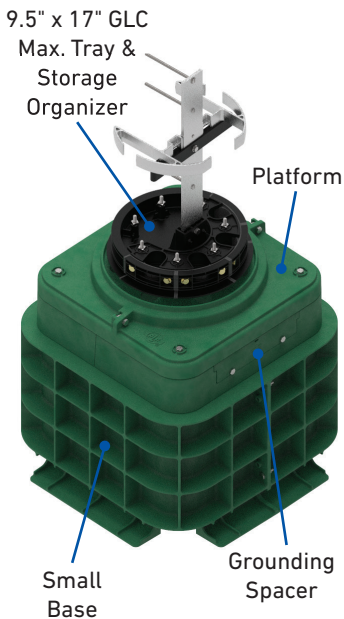

## COYOTE 9.5" x 17" GLC with Maximum Tray & Storage Organizer

<b>Catalog Numbers</b>		<b>COYGLC-F2-000, COYGLC-F2B-000, COYGLC-F2B-100</b>
Splice Capacity (Maximum) – Single Fusion (Low Profile, 80809958), Single Fusion (Low Profile, 80813152), Single Fusion (Deep Profile, 80808945), Mass Fusion (Deep Profile, LGSTR144)		312, 468, 240, N/A
Number of Splice Trays – 80809958, 80813152, 80808945, LGSTR144		13, 13, 6, N/A
Cable Ports <sup>1</sup>		4
Cable Diameters	Small Base	0.093" – 0.60" (2.4 – 15.2 mm) and Flat Drop
	Large Base	0.093" – 1.25" (2.4 – 31.8 mm) and Flat Drop
Ground Studs		4
Configuration		Butt
Cable Types		Buffer Tube Only
Application		Pedestal
Ingress Protection		In accordance with Telcordia® GR-771-CORE, Pedestal; IP-68
Size <sup>2</sup>		15.4" L x 15.4" W x 20.4" H (390 x 390 x 520 mm)
Kit Contents <sup>3</sup>	COYGLC-F2-000	Includes (1) Standard Platform
	COYGLC-F2B-000	Includes (1) Standard Platform and (1) Small Base
	COYGLC-F2B-100	Includes (1) Standard Platform, (1) Small Base, & (1) Grounding Spacer Kit

<sup>1</sup> Multi-hole grommets allow for more than one cable to enter each cable port

<sup>2</sup> Includes platform, collar, and dome assembly only. See COYOTE GLC Bases for base sizes

<sup>3</sup> All kits include (1) Green GLC Dome, (1) COYOTE 9.5" End Plate with Organizer, (1) Gasket, (1) Collar, (2) 2-Hole Grommets, (1) 4-Hole Grommet, (1) 6-Hole Grommet, (1) Splice Tray (Catalog Number: 80808945) and Cable Restraint Hardware.

# SPECIFICATIONS

## COYOTE 9.5" x 17" GLC with Cross-Connect Organizer

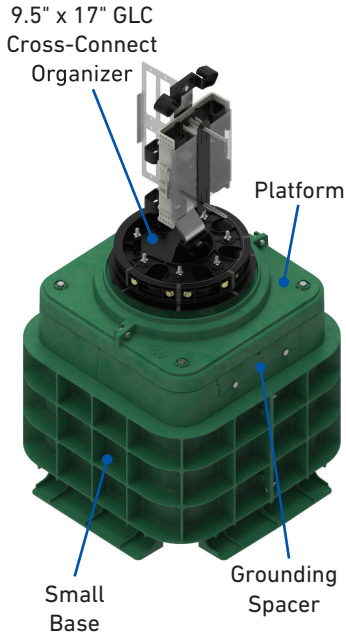

<b>Catalog Number</b>		<b>COYGLC-F3-000, COYGLC-F3B-000, COYGLC-F3B-100</b>
Splice Capacity (Maximum) – Single Fusion (Low Profile, 80809958), Single Fusion (Low Profile, 80813152), Single Fusion (Deep Profile, 80808945), Mass Fusion (Deep Profile, LGSTR144)		96, 144, 80, 288
Number of Splice Trays – 80809958, 80813152, 80808945, LGSTR144		4, 4, 2, 2
Cable Ports <sup>1</sup>		4
Cable Diameters	Small Base	0.093" – 0.60" (2.4 – 15.2 mm) and Flat Drop
	Large Base	0.093" – 1.25" (2.4 – 31.8 mm) and Flat Drop
Ground Studs		4
Configuration		Butt
Cable Types		Buffer Tube or Ribbon
Application		Pedestal
Ingress Protection		In accordance with Telcordia® GR-771-CORE, Pedestal; IP-68
Size <sup>2</sup>		15.4" L x 15.4" W x 20.4" H (390 x 390 x 520 mm)
Adapter Port Quantity (Maximum)		48 SC or 96 LC
Kit Contents <sup>3</sup>	COYGLC-F3-000	Includes (1) Standard Platform
	COYGLC-F3B-000	Includes (1) Standard Platform and (1) Small Base
	COYGLC-F3B-100	Includes (1) Standard Platform, (1) Small Base, & (1) Grounding Spacer Kit

<sup>1</sup> Multi-hole grommets allow for more than one cable to enter each cable port

<sup>2</sup> Includes platform, collar, and dome assembly only. See COYOTE GLC Bases for base sizes

<sup>3</sup> All kits include (1) Green GLC Dome, (1) COYOTE 9.5" End Plate with Organizer, (1) Gasket, (1) Collar, (2) 2-Hole Grommets, (1) 4-Hole Grommet, (1) 6-Hole Grommet, (1) Splice Tray (**Catalog Number: 80808945**) and Cable Restraint Hardware. Additional selections of adapter and pigtail accessories are required.

## COYOTE 9.5" x 17" GLC with OptiTap® Organizer

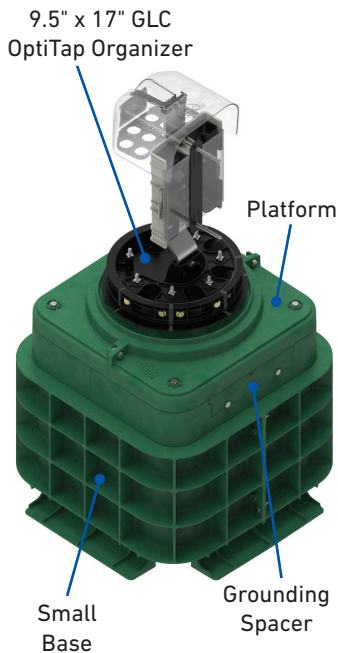

<b>Catalog Number</b>		<b>COYGLC-F4-000, COYGLC-F4B-000, COYGLC-F4B-100</b>
Splice Capacity (Maximum) – Single Fusion (Low Profile, 80809958), Single Fusion (Low Profile, 80813152), Single Fusion (Deep Profile, 80808945), Mass Fusion (Deep Profile, LGSTR144)		96, 144, 80, 288
Number of Splice Trays – 80809958, 80813152, 80808945, LGSTR144		4, 4, 2, 2
Cable Ports <sup>1</sup>		4
Cable Diameters	Small Base	0.093" – 0.60" (2.4 – 15.2 mm) and Flat Drop
	Large Base	0.093" – 1.25" (2.4 – 31.8 mm) and Flat Drop
Ground Studs		4
Configuration		Butt
Cable Types		Buffer Tube or Ribbon and Pre-Connectorized Hardened Drop
Application		Pedestal
Ingress Protection		In accordance with Telcordia® GR-771-CORE, Pedestal; IP-68
Size <sup>2</sup>		15.4" L x 15.4" W x 20.4" H (390 x 390 x 520 mm)
Kit Contents <sup>3</sup>	COYGLC-F4-000	Includes (1) Standard Platform
	COYGLC-F4B-000	Includes (1) Standard Platform and (1) Small Base
	COYGLC-F4B-100	Includes (1) Standard Platform, (1) Small Base, & (1) Grounding Spacer Kit

<sup>1</sup> Multi-hole grommets allow for more than one cable to enter each cable port

<sup>2</sup> Includes platform, collar, and dome assembly only. See COYOTE GLC Bases for base sizes

<sup>3</sup> All kits include (1) Green GLC Dome, (1) COYOTE 9.5" End Plate with Organizer, (1) Gasket, (1) Collar, (2) 2-Hole Grommets, (1) 4-Hole Grommet, (1) 6-Hole Grommet, (1) Splice Tray (**Catalog Number: 80808945**) and Cable Restraint Hardware. Additional selection of OptiTap® adapters are required.

## SPECIFICATIONS

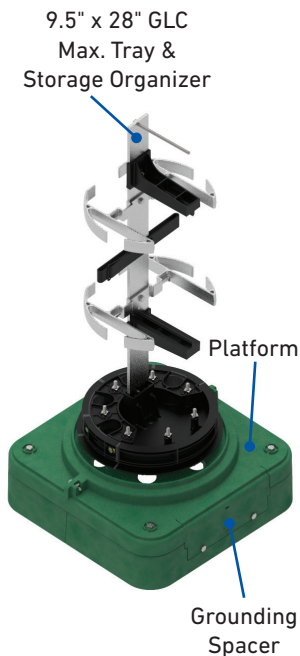
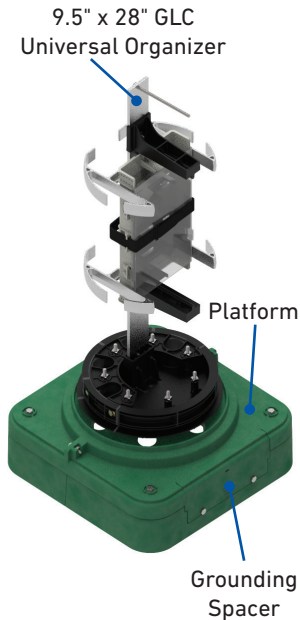

### COYOTE 9.5" x 28" GLC with Universal Organizer

Catalog Number		COYGLC-F5-000, COYGLC-F5-100
Splice Capacity (Maximum) – Single Fusion (Standard Profile, 80810086), Single Fusion (Deep Profile, LGSTS72), Mass Fusion (Deep Profile, LGSTR216)		180, 288, 864
Number of Splice Trays – 80810086, LGSTS72, LGSTR216		5, 4, 4
Cable Ports <sup>1</sup>		4
Cable Diameters	Small Base	0.093" – 0.60" (2.4 – 15.2 mm) and Flat Drop
	Large Base	0.093" – 1.25" (2.4 – 31.8 mm) and Flat Drop
Ground Studs		4
Configuration		Butt
Cable Types		Buffer Tube or Ribbon
Application		Pedestal
Ingress Protection		In accordance with Telcordia® GR-771-CORE, Pedestal; IP-68
Size <sup>2</sup>		15.4" L x 15.4" W x 31.6" H (390 x 390 x 800 mm)
Kit	COYGLC-F5-000	Includes (1) Standard Platform
Contents <sup>3</sup>	COYGLC-F5-100	Includes (1) Platform with Cutout and (1) Grounding Spacer Kit

<sup>1</sup> Multi-hole grommets allow for more than one cable to enter each cable port  
<sup>2</sup> Includes platform, collar, and dome assembly only. See COYOTE GLC Bases for base sizes  
<sup>3</sup> All kits include (1) Green GLC Dome, (1) COYOTE 9.5" End Plate with Organizer, (1) Gasket, (1) Collar, (2) 1-Hole Grommets 0.60" – 0.85" (15.2 – 21.6 mm), (1) 2-Hole Grommet, (1) 7-Hole Grommet, (1) Splice Tray (Catalog Number: LGSTS72) and Cable Restraint Hardware.

### COYOTE 9.5" x 28" GLC with Max. Tray & Storage Organizer

Catalog Number		COYGLC-F6-000, COYGLC-F6-100
Splice Capacity (Maximum) – Single Fusion (Standard Profile, 80810086), Single Fusion (Deep Profile, LGSTS72), Mass Fusion (Deep Profile, LGSTR216)		324, 432, N/A
Number of Splice Trays – 80810086, LGSTS72, LGSTR216		9, 6, N/A
Cable Ports <sup>1</sup>		4
Cable Diameters	Small Base	0.093" – 0.60" (2.4 – 15.2 mm) and Flat Drop
	Large Base	0.093" – 1.25" (2.4 – 31.8 mm) and Flat Drop
Ground Studs		4
Configuration		Butt
Cable Types		Buffer Tube Only
Application		Pedestal
Ingress Protection		In accordance with Telcordia® GR-771-CORE, Pedestal; IP-68
Size <sup>2</sup>		15.4" L x 15.4" W x 31.6" H (390 x 390 x 800 mm)
Kit	COYGLC-F6-000	Includes (1) Standard Platform
Contents <sup>3</sup>	COYGLC-F6-100	Includes (1) Platform with Cutout and (1) Grounding Spacer Kit

<sup>1</sup> Multi-hole grommets allow for more than one cable to enter each cable port  
<sup>2</sup> Includes platform, collar, and dome assembly only. See COYOTE GLC Bases for base sizes  
<sup>3</sup> All kits include (1) Green GLC Dome, (1) COYOTE 9.5" End Plate with Organizer, (1) Gasket, (1) Collar, (2) 1-Hole Grommets 0.60" – 0.85" (15.2 – 21.6 mm), (1) 2-Hole Grommet, (1) 7-Hole Grommet, (1) Splice Tray (Catalog Number: LGSTS72) and Cable Restraint Hardware.

## SPECIFICATIONS

9.5" x 28" GLC Cross-Connect Organizer

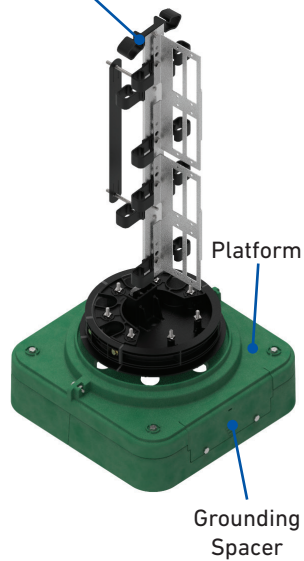

### COYOTE 9.5" x 28" GLC with Cross-Connect Organizer

Catalog Numbers		COYGLC-F7-000, COYGLC-F7-100
Splice Capacity (Maximum) – Single Fusion (Standard Profile, 80810086), Single Fusion (Deep Profile, LGSTS72), Mass Fusion (Deep Profile, LGSTR216)		180, 288, N/A
Number of Splice Trays – 80810086, LGSTS72, LGSTR216		5, 4, N/A
Cable Ports <sup>1</sup>		4
Cable Diameters	Small Base	0.093" – 0.60" (2.4 – 15.2 mm) and Flat Drop
	Large Base	0.093" – 1.25" (2.4 – 31.8 mm) and Flat Drop
Ground Studs		4
Configuration		Butt
Cable Types		Buffer Tube or Ribbon
Application		Pedestal
Ingress Protection		In accordance with Telcordia® GR-771-CORE, Pedestal; IP-68
Size <sup>2</sup>		15.4" L x 15.4" W x 31.6" H (390 x 390 x 800 mm)
Adapter Port Quantity (Maximum)		96 SC or 196 LC
Kit Contents <sup>3</sup>	COYGLC-F7-000	Includes (1) Standard Platform
	COYGLC-F7-100	Includes (1) Platform with Cutout and (1) Grounding Spacer Kit

<sup>1</sup> Multi-hole grommets allow for more than one cable to enter each cable port

<sup>2</sup> Includes platform, collar, and dome assembly only. See COYOTE GLC Bases for base sizes

<sup>3</sup> All kits include (1) Green GLC Dome, (1) COYOTE 9.5" End Plate with Organizer, (1) Gasket, (1) Collar, (2) 1-Hole Grommets 0.60" – 0.85" (15.2 – 21.6 mm), (1) 2-Hole Grommet, (1) 7-Hole Grommet, (1) Splice Tray (**Catalog Number LGSTS72**) and Cable Restraint Hardware. Additional selections of adapter and pigtail accessories are required.

## COYOTE GLC BASE AND COVER



COYOTE GLC Small Base  
17" W x 17" L x 13" H (430 x 430 x 330 mm)  
For Fiber Optic Cables with Diameters  
up to 0.60" (15.2 mm)  
**Catalog Number: COYGLC-B-000**

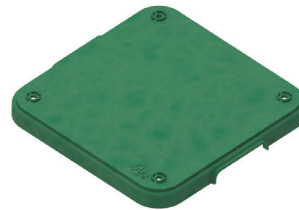

COYOTE GLC Small Base Cover  
**NOTE:** Can not be used as a plug  
for the large base cover  
**Catalog Number: 80809781**

## COYOTE® GLC SPACERS

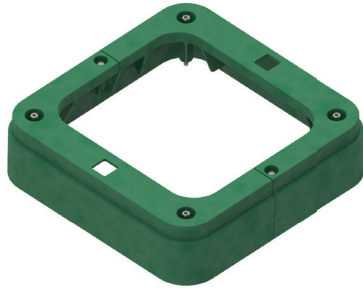

**Standard Spacer**  
Raises the base height by 3" for adjustment to ground level

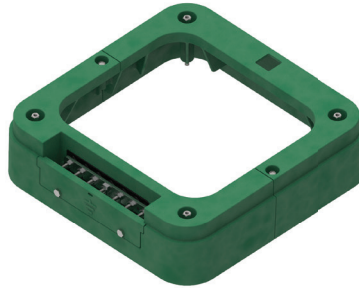

**Grounding Spacer**  
Raises the base height by 3" for adjustment to ground level. Provides 7 external isolated ground connections

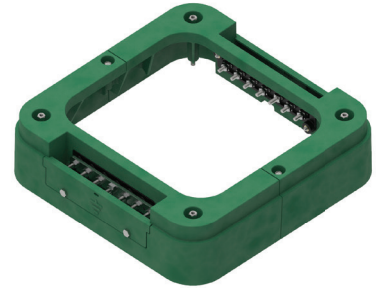

**Dual Grounding Spacer**  
Raises the base height by 3" for adjustment to ground level. Provides 14 external isolated ground connections

### COYOTE GLC Spacers for Small Base

Catalog Number	Description
COYGLC-S1-000	COYOTE GLC Standard Spacer for Small Base – Includes (2) Standard Spacer Halves, (2) Self-Tapping Bolts, and (4) 3.49" L (89 mm) Spacer Fasteners
COYGLC-S2-000	COYOTE GLC Grounding Spacer for Small Base – Includes (1) Standard Spacer Half, (1) Grounding Spacer Half, (1) Ground Stud Mounting Plate, (7) Ground Studs with Fasteners, (1) Bonding Plate, (1) Standard Access Cover, (7) Ground Lead Assemblies, (2) Self-Tapping Bolts, and (4) 3.49" L (89 mm) Spacer Fasteners
COYGLC-S3-000	COYOTE GLC Dual Grounding Spacer for Small Base – Includes (2) Grounding Spacer Halves, (2) Ground Stud Mounting Plate, (14) Ground Studs with Fasteners, (2) Bonding Plate, (2) Standard Access Cover, (14) Ground Lead Assemblies, (2) Self-Tapping Bolts, and (4) 3.49" L (89 mm) Spacer Fasteners



COYOTE GLC without Grounding Spacer



COYOTE GLC with Grounding Spacer



## ACCESSORIES FOR CROSS-CONNECT APPLICATIONS

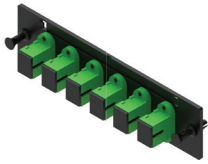

**6-Port SC/APC Adapter Module**

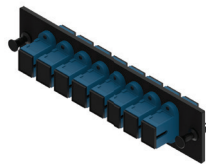

**8-Port SC/UPC Adapter Module**

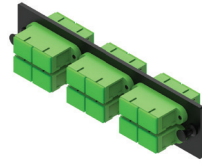

**12-Port SC/APC Adapter Module**

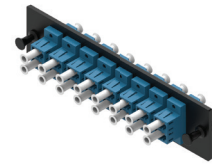

**16-Port LC/UPC Adapter Module**

### COYOTE Adapter Modules

Catalog Number	Description
6SCAPC	Adapter Kit – Includes (1) 6-Port SC/APC Adapter Module
8SCAPC	Adapter Kit – Includes (1) 8-Port SC/APC Adapter Module
12SMDSCA	Adapter Kit – Includes (1) 12-Port SC/APC Adapter Module
6SMSC	Adapter Kit – Includes (1) 6-Port SC/UPC Adapter Module
8SMSC	Adapter Kit – Includes (1) 8-Port SC/UPC Adapter Module
12SMDSC	Adapter Kit – Includes (1) 12-Port SC/UPC Adapter Module
12SMLCA	Adapter Kit – Includes (1) 12-Port LC/APC Adapter Module
16SMLCA	Adapter Kit – Includes (1) 16-Port LC/APC Adapter Module
24LCAPC	Adapter Kit – Includes (1) 24-Port LC/APC Adapter Module
12SMLC	Adapter Kit – Includes (1) 12-Port LC/UPC Adapter Module
16SMLC	Adapter Kit – Includes (1) 16-Port LC/UPC Adapter Module
24SMLC	Adapter Kit – Includes (1) 24-Port LC/UPC Adapter Module

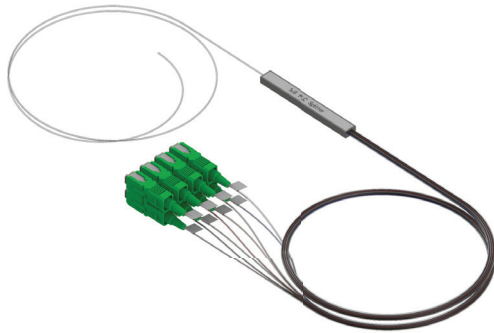

**1x8 SC/APC PLC Pre-Connectorized Splitter**

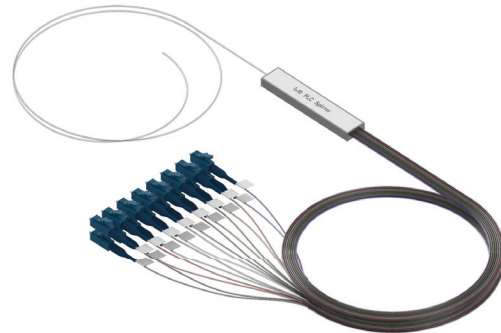

**1x16 LC/UPC PLC Pre-Connectorized Splitter**

### COYOTE GLC Pre-Connectorized Splitters

Catalog Number	Description
COYGLC-1X8-SCA	Pre-Connectorized Splitter – 1x8 SC/APC with 24" Output Legs
COYGLC-1X16-SCA	Pre-Connectorized Splitter – 1x16 SC/APC with 24" Output Legs
COYGLC-1X32-SCA	Pre-Connectorized Splitter – 1x32 SC/APC with 24" Output Legs
COYGLC-1X8-SCU	Pre-Connectorized Splitter – 1x8 SC/UPC with 24" Output Legs
COYGLC-1X16-SCU	Pre-Connectorized Splitter – 1x16 SC/UPC with 24" Output Legs
COYGLC-1X32-SCU	Pre-Connectorized Splitter – 1x32 SC/UPC with 24" Output Legs
COYGLC-1X8-LCA	Pre-Connectorized Splitter – 1x8 LC/APC with 24" Output Legs
COYGLC-1X16-LCA	Pre-Connectorized Splitter – 1x16 LC/APC with 24" Output Legs
COYGLC-1X32-LCA	Pre-Connectorized Splitter – 1x32 LC/APC with 24" Output Legs
COYGLC-1X8-LCU	Pre-Connectorized Splitter – 1x8 LC/UPC with 24" Output Legs
COYGLC-1X16-LCU	Pre-Connectorized Splitter – 1x16 LC/UPC with 24" Output Legs
COYGLC-1X32-LCU	Pre-Connectorized Splitter – 1x32 LC/UPC with 24" Output Legs

## ACCESSORIES FOR CROSS-CONNECT APPLICATIONS

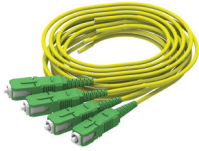

**2 mm Jacketed SC/APC Pigtails with Short Connector Boots**

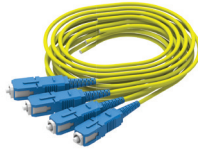

**2 mm Jacketed SC/UPC Pigtails with Short Connector Boots**



**2 mm Jacketed LC/APC Pigtails with Short Connector Boots**



**2 mm Jacketed LC/UPC Pigtails with Short Connector Boots**

### COYOTE 2 mm Jacketed Fiber Pigtail Kits - Short Boot Connectors

Catalog Number	Description
COYTRM-2PK-SCA-SB	Pigtail Kit – Includes (2) 2 mm SC/APC Jacketed Fiber Pigtails with Short Boot Connectors, 2 meters Long
COYTRM-3PK-SCA-SB	Pigtail Kit – Includes (3) 2 mm SC/APC Jacketed Fiber Pigtails with Short Boot Connectors, 2 meters Long
COYTRM-4PK-SCA-SB	Pigtail Kit – Includes (4) 2 mm SC/APC Jacketed Fiber Pigtails with Short Boot Connectors, 2 meters Long
COYTRM-2PK-SCU-SB	Pigtail Kit – Includes (2) 2 mm SC/UPC Jacketed Fiber Pigtails with Short Boot Connectors, 2 meters Long
COYTRM-3PK-SCU-SB	Pigtail Kit – Includes (3) 2 mm SC/UPC Jacketed Fiber Pigtails with Short Boot Connectors, 2 meters Long
COYTRM-4PK-SCU-SB	Pigtail Kit – Includes (4) 2 mm SC/UPC Jacketed Fiber Pigtails with Short Boot Connectors, 2 meters Long
COYTRM-4PK-LCA-SB	Pigtail Kit – Includes (4) 2 mm LC/APC Jacketed Fiber Pigtails with Short Boot Connectors, 2 meters Long
COYTRM-4PK-LCU-SB	Pigtail Kit – Includes (4) 2 mm LC/UPC Jacketed Fiber Pigtails with Short Boot Connectors, 2 meters Long

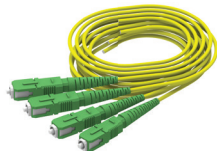

**2 mm Jacketed SC/APC Pigtails with Standard Connector Boots**

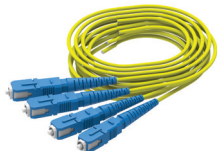

**2 mm Jacketed SC/UPC Pigtails with Standard Connector Boots**



**2 mm Jacketed LC/APC Pigtails with Standard Connector Boots**

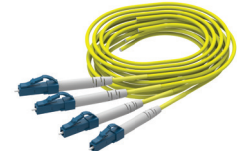

**2 mm Jacketed LC/UPC Pigtails with Standard Connector Boots**

### COYOTE 2 mm Jacketed Fiber Pigtail Kits - Standard Boot Connectors

Catalog Number	Description
COYTRM-2PK-SCA	Pigtail Kit – Includes (2) 2 mm SC/APC Jacketed Fiber Pigtails with Standard Boot Connectors, 2 meters Long
COYTRM-3PK-SCA	Pigtail Kit – Includes (3) 2 mm SC/APC Jacketed Fiber Pigtails with Standard Boot Connectors, 2 meters Long
COYTRM-4PK-SCA	Pigtail Kit – Includes (4) 2 mm SC/APC Jacketed Fiber Pigtails with Standard Boot Connectors, 2 meters Long
COYTRM-2PK-SCU	Pigtail Kit – Includes (2) 2 mm SC/UPC Jacketed Fiber Pigtails with Standard Boot Connectors, 2 meters Long
COYTRM-3PK-SCU	Pigtail Kit – Includes (3) 2 mm SC/UPC Jacketed Fiber Pigtails with Standard Boot Connectors, 2 meters Long
COYTRM-4PK-SCU	Pigtail Kit – Includes (4) 2 mm SC/UPC Jacketed Fiber Pigtails with Standard Boot Connectors, 2 meters Long
COYTRM-4PK-LCA	Pigtail Kit – Includes (4) 2 mm LC/APC Jacketed Fiber Pigtails with Standard Boot Connectors, 2 meters Long
COYTRM-4PK-LCU	Pigtail Kit – Includes (4) 2 mm LC/UPC Jacketed Fiber Pigtails with Standard Boot Connectors, 2 meters Long

## ACCESSORIES FOR CROSS-CONNECT APPLICATIONS

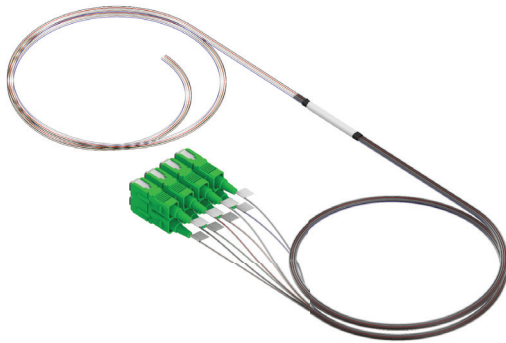

8 Fiber SC/APC GLC Pigtail Bundle

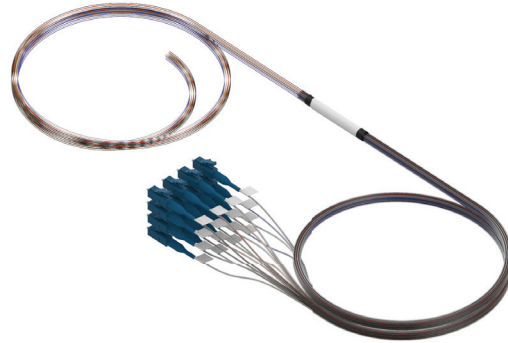

16 Fiber LC/UPC GLC Pigtail Bundle

### COYOTE GLC Pigtail Bundles

Catalog Number	Description
COYGLC-4FB-SCA	GLC Pigtail Bundle – Includes (4) SC/APC 900 μm Pigtails with 24" Output Legs
COYGLC-8FB-SCA	GLC Pigtail Bundle – Includes (8) SC/APC 900 μm Pigtails with 24" Output Legs
COYGLC-12FB-SCA	GLC Pigtail Bundle – Includes (12) SC/APC 900 μm Pigtails with 24" Output Legs
COYGLC-16FB-SCA	GLC Pigtail Bundle – Includes (16) SC/APC 900 μm Pigtails with 24" Output Legs
COYGLC-32FB-SCA	GLC Pigtail Bundle – Includes (32) SC/APC 900 μm Pigtails with 24" Output Legs
COYGLC-4FB-SCU	GLC Pigtail Bundle – Includes (4) SC/UPC 900 μm Pigtails with 24" Output Legs
COYGLC-8FB-SCU	GLC Pigtail Bundle – Includes (8) SC/UPC 900 μm Pigtails with 24" Output Legs
COYGLC-12FB-SCU	GLC Pigtail Bundle – Includes (12) SC/UPC 900 μm Pigtails with 24" Output Legs
COYGLC-16FB-SCU	GLC Pigtail Bundle – Includes (16) SC/UPC 900 μm Pigtails with 24" Output Legs
COYGLC-32FB-SCU	GLC Pigtail Bundle – Includes (32) SC/UPC 900 μm Pigtails with 24" Output Legs
COYGLC-4FB-LCA	GLC Pigtail Bundle – Includes (4) LC/APC 900 μm Pigtails with 24" Output Legs
COYGLC-8FB-LCA	GLC Pigtail Bundle – Includes (8) LC/APC 900 μm Pigtails with 24" Output Legs
COYGLC-12FB-LCA	GLC Pigtail Bundle – Includes (12) LC/APC 900 μm Pigtails with 24" Output Legs
COYGLC-16FB-LCA	GLC Pigtail Bundle – Includes (16) LC/APC 900 μm Pigtails with 24" Output Legs
COYGLC-32FB-LCA	GLC Pigtail Bundle – Includes (32) LC/APC 900 μm Pigtails with 24" Output Legs
COYGLC-4FB-LCU	GLC Pigtail Bundle – Includes (4) LC/UPC 900 μm Pigtails with 24" Output Legs
COYGLC-8FB-LCU	GLC Pigtail Bundle – Includes (8) LC/UPC 900 μm Pigtails with 24" Output Legs
COYGLC-12FB-LCU	GLC Pigtail Bundle – Includes (12) LC/UPC 900 μm Pigtails with 24" Output Legs
COYGLC-16FB-LCU	GLC Pigtail Bundle – Includes (16) LC/UPC 900 μm Pigtails with 24" Output Legs
COYGLC-32FB-LCU	GLC Pigtail Bundle – Includes (32) LC/UPC 900 μm Pigtails with 24" Output Legs

### COYOTE Field Installable Connectors

Catalog Number	Description
80813501	Field Installable Connector Kit – Includes (6) SC/APC Field Installable Connectors
80813502	Field Installable Connector Kit – Includes (12) SC/APC Field Installable Connectors
80813503	Field Installable Connector Kit – Includes (6) SC/UPC Field Installable Connectors
80813504	Field Installable Connector Kit – Includes (12) SC/UPC Field Installable Connectors
80813505	Field Installable Connector Kit – Includes (6) LC/APC Field Installable Connectors
80813506	Field Installable Connector Kit – Includes (12) LC/APC Field Installable Connectors
80813507	Field Installable Connector Kit – Includes (6) LC/UPC Field Installable Connectors
80813508	Field Installable Connector Kit – Includes (12) LC/UPC Field Installable Connectors

## ACCESSORIES FOR OPTITAP® APPLICATIONS



OptiTap Adapter



Hardened Adapter Installation Tool

### Hardened Adapter Accessories

Catalog Number	Description
8003715	Hardened Adapter Kit – Includes (1) OptiTap Adapter and (1) Installation Tool
8004115	Bulk Pack of OptiTap Adapters – Includes (10) OptiTap Adapters
80807972	Hardened Adapter Installation Tool
8003724	Port Plug Kit – Included (1) Port Plug and (1) Installation Tool
8004060	Bulk Pack of Port Plugs – Includes (10) Port Plugs

## ACCESSORIES



Retention Stake with Anchor Plate

### COYOTE GLC Accessories

Catalog Number	Description
80809958	Splice Tray, COYOTE LITE-GRIP® Short, Low Profile, 24 CT., Single Fusion
80813152	Splice Tray, COYOTE LITE-GRIP Short, Low Profile, 36 CT., Single Fusion
80808945	Splice Tray, COYOTE LITE-GRIP Short, Deep Profile, 40 CT., Single Fusion
LGSTR144	Splice Tray, COYOTE LITE-GRIP Short, Deep Profile, 144 CT., Mass Fusion
80810086	Splice Tray, COYOTE LITE-GRIP Long, Standard Profile, 36 CT., Single Fusion
LGSTS72	Splice Tray, COYOTE LITE-GRIP Long, Deep Profile, 72 CT., Single Fusion
LGSTR216	Splice Tray, COYOTE LITE-GRIP Long, Deep Profile, 216 CT., Mass Fusion
8004160	Heat Shrink Splice Protector Kit – Includes (50) 40 mm Mass Fusion
8004095	Heat Shrink Splice Protector Kit – Includes (50) 40 mm Single Fusion
8003717	Heat Shrink Splice Protector Kit – Includes (50) 60 mm Single Fusion
80809788	Retention Stake with Anchor Plate for Small Base 42" (1066 mm)
80803989	Shield Connector
80808613	Express Fiber Storage Ring for Deep Profile LITE-GRIP Splice Trays
80809205	Strength Member Bracket Kit – Includes (2) Short L-Brackets
80808651	Strength Member Bracket Kit – Includes (4) Long L-Brackets
80811037	4-Port Cable Retention Bobbin Kit
80811036	6-Port Drop Cable Retention Bobbin Kit
80812928	6/8-Port Drop Cable Retention Bobbin Kit

OptiTap® is a registered trademark of Corning Cable Systems.

CO-CA-1004-20



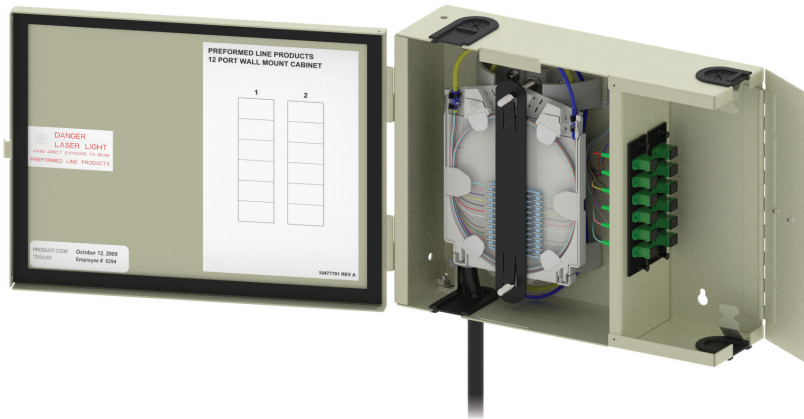

# SECTION 5 DEMARICATION

COYOTE® FIBER OPTIC SOLUTIONS

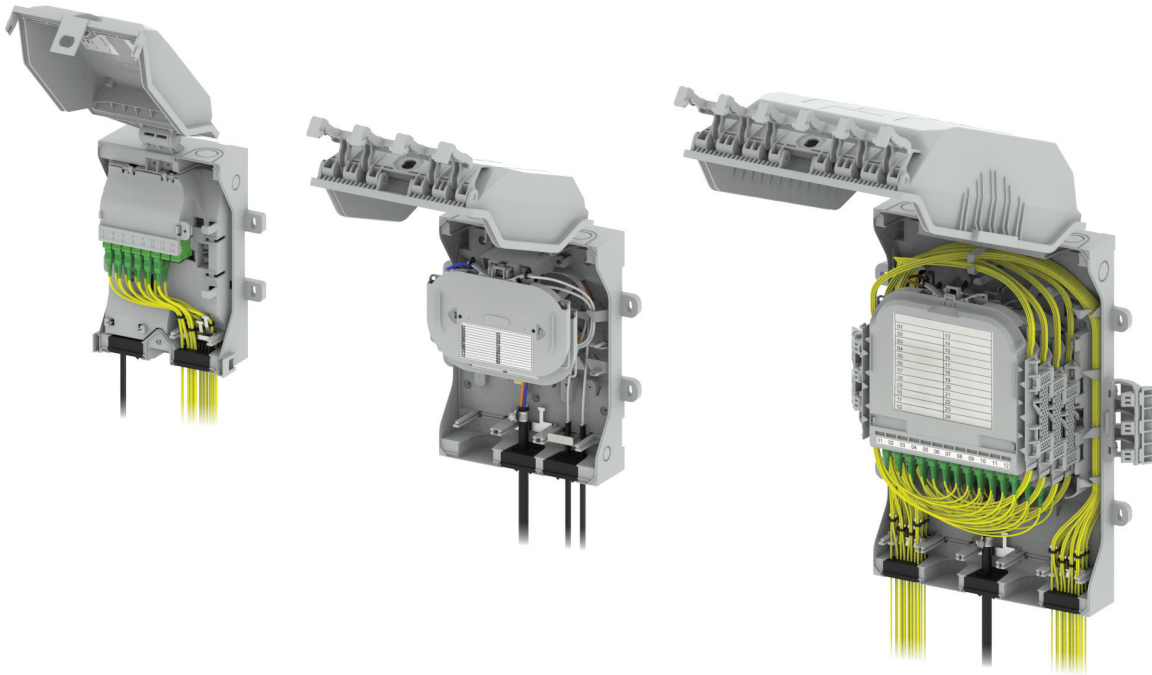

## COYOTE® DEN

**COYOTE DEN Wall Boxes** are designed for indoor or outdoor fiber splice points commonly found at multi-dwelling units or utility poles that require the distribution of multiple drop cables or patch cords. The COYOTE DEN units are configured with fiber organizers for either direct splice or cross-connect applications and incorporate a flip tray management system to help organize customer connections. These durable wall boxes utilize a cable grommet system and an integrated cover gasket to prevent water and dust ingress into the closure, to ensure the protection of the critical network connections located inside them.

### FEATURES AND BENEFITS

- Available in three different sizes (DEN2, DEN3, and DEN5) for either direct splice or cross-connect applications
- Can be directly mounted to an interior or exterior wall or banded to a pole
- Hinged cover that secures to the base with either locking tabs or hinging latches
- Optional lock for added security of the cover to the base
- Flexible grommet sealing system supports round and flat cable profiles
- Organizers are designed to accept flip trays which allow easy access to fibers and slack buffer tubes
- Flip trays store single fusion splices or PLC splitters
- Cross-connect organizer in the largest wall box size (DEN5) utilizes a flip cassette system for better management of patch cord routing and fiber connections
- Cross-connect organizers are compatible with SC or LC adapters (APC or UPC)
- Grommets, splice trays/cassettes, and organizer are supplied with each wall box
- Designed and tested in accordance with IEC 61753-1 Category A and rated to IP-65 requirements

## CROSS-CONNECT ORGANIZER SYSTEMS FOR COYOTE® DEN2 & DEN3

- Removable organizers that protect the splice tray and buffer tubes from being tampered with once installed into the wall box
- Allows for incoming cables to be installed and spliced outside of the wall box
- Utilizes a 24 CT. low-profile flip splice tray to allow access to slack buffer tube storage
- Adapter cover protects incoming connections from being tampered with
- COYOTE DEN2 organizer accepts up to 8 duplex SC or quad LC connectors (16 SC or 32 LC connections). The DEN3 organizer accepts up to 12 duplex SC or quad LC connectors (24 SC or 48 LC connections)

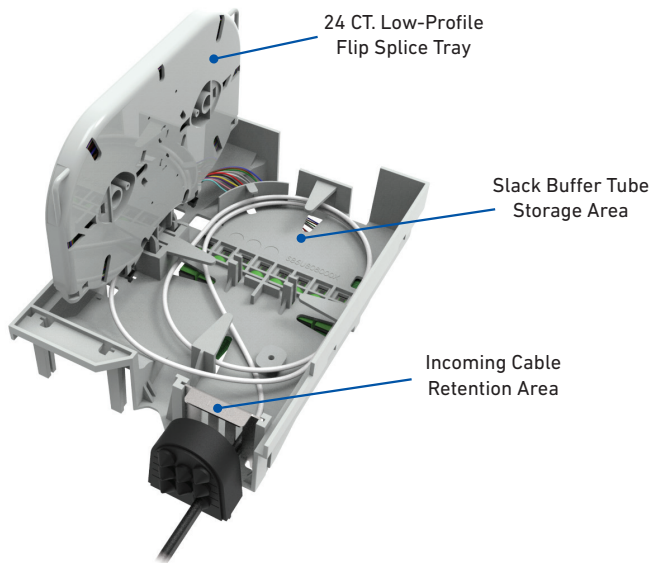

Bottom of COYOTE DEN2 Cross-Connect Organizer

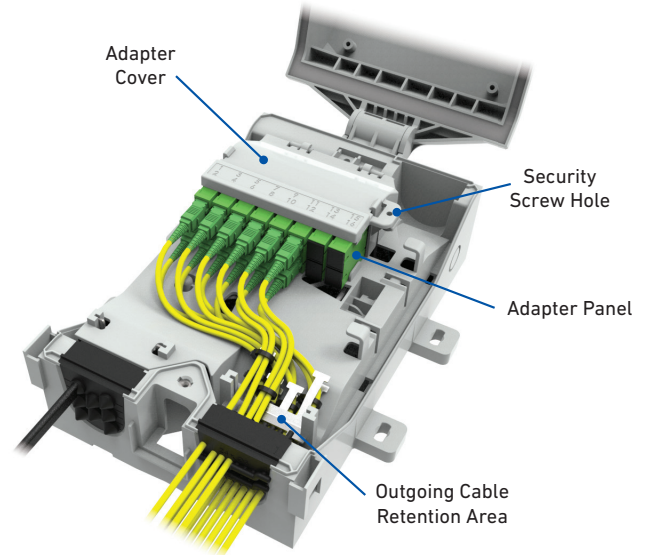

Top of COYOTE DEN2 Cross-Connect Organizer

## FOR COYOTE® DEN5

- Organizer can be removed from the wall box to enable better access to routing features
- Utilizes a cassette tray system that allows splicing and fiber connections to be made on the same tray
- Modular design allows the cassette trays to rotate to gain access to fiber connections or slack buffer tubes
- Routing channels on the sides of each cassette tray allow incoming jumper cables or connectorized drop cables to route from the back of the wall box

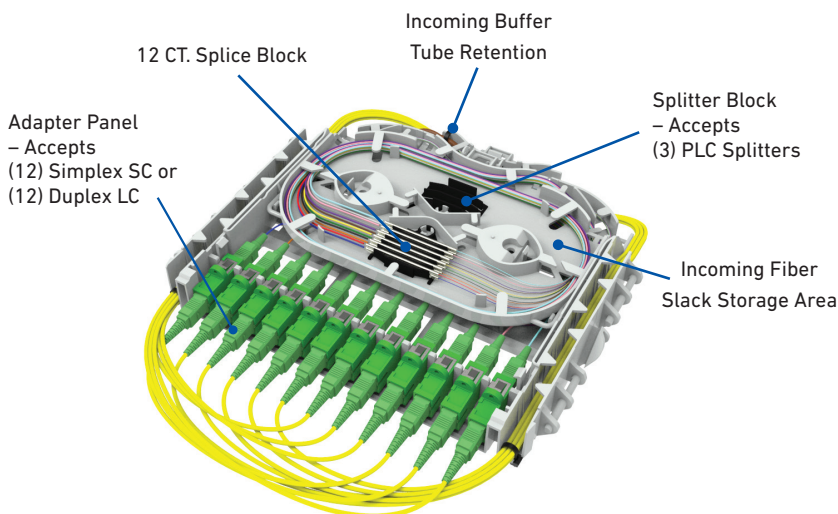

Cassette Tray with Cover Removed

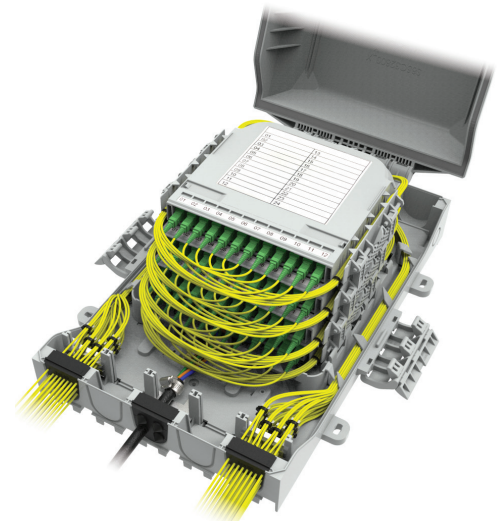

COYOTE DEN5 Cross-Connect Organizer with 4 Cassette Trays



## COYOTE® DEN2

### Specifications

Catalog Number	COYDEN2-SPL	COYDEN2-XC
Application	Direct Splice	Cross-Connect
Splice Capacity (Maximum)	48 CT. Single Fusion	24 CT. Single Fusion
Number of Splice Trays (Maximum)	2 Low Profile	1 Low Profile
Adapter Port Quantity (Maximum)	Not Available	16 SC (Duplex) or 32 LC (Quad)
Indoor Cable Ports <sup>1,3</sup>	5	
Outdoor Cable Ports <sup>2,3</sup>	2	
Cable Diameters	0.07" – 0.12" (1.8 mm – 3.0 mm) & 0.14" – 0.51" (3.6 mm – 13.0 mm)	
Configuration	In-Line or Butt	
Application	Wall or Pole Mount	
Ingress Protection	IP-65	
Flame Protection	V0	
Size	9.9" L x 5.9" W x 3.3" H (252 x 150 x 85 mm)	

<sup>1</sup> Cable ports located on all sides of the wall box can be used for indoor applications.

<sup>2</sup> Cable ports located at bottom of the wall box can only be used for outdoor applications.

<sup>3</sup> Multi-hole grommets allow for more than one cable to enter each cable port.

### Components

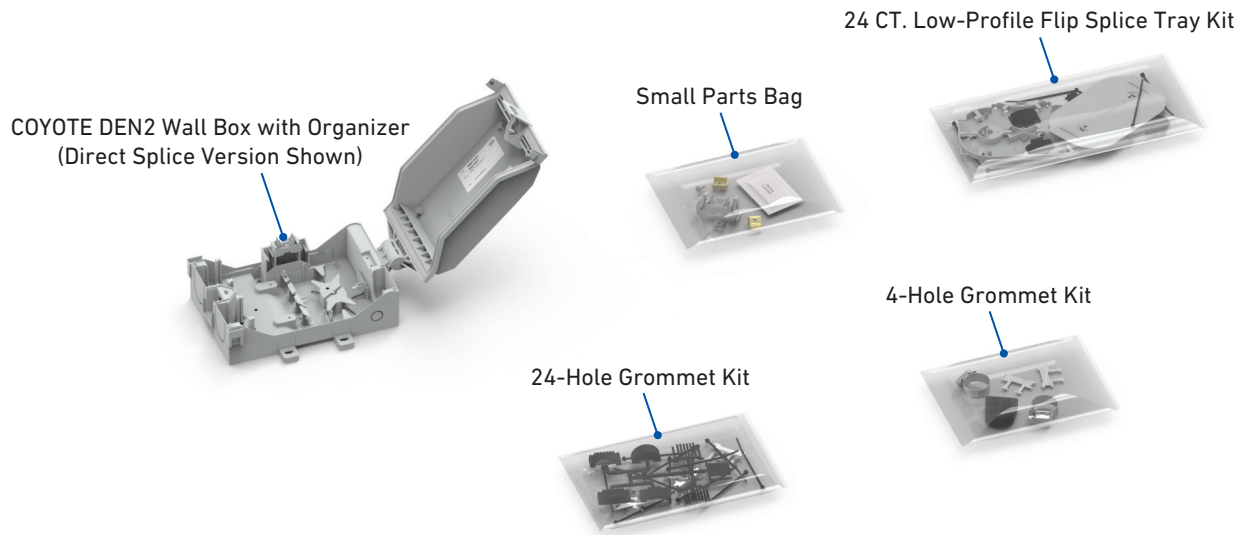

### COYOTE DEN2 Wall Box Kits

Catalog Number	Description
COYDEN2-SPL	COYOTE DEN2 Wall Box with Direct Splice Organizer – Includes (2) COYOTE DEN 24 CT. Low-Profile Flip Splice Tray Kits, (1) 4-Hole Grommet Kit: (2 Holes) 0.38" – 0.46" (9.7 – 11.7 mm) & (2 Holes) 0.46" – 0.51" (11.7 – 13.0 mm), (1) 24-Hole Grommet Kit: (24 Holes) 0.07" – 0.12" (1.8 – 3.0 mm), & (1) Small Parts Bag
COYDEN2-XC	COYOTE DEN2 Wall Box with Cross-Connect Organizer – Includes (1) COYOTE DEN 24 CT. Low-Profile Flip Splice Tray Kits, (1) 4-Hole Grommet Kit: (2 Holes) 0.38" – 0.46" (9.7 – 11.7 mm) & (2 Holes) 0.46" – 0.51" (11.7 – 13.0 mm), (1) 24-Hole Grommet Kit: (24 Holes) 0.07" – 0.12" (1.8 – 3.0 mm), & (1) Small Parts Bag

# COYOTE® DEN3

## Specifications

Catalog Number	COYDEN3-SPL	COYDEN3-XC
Application	Direct Splice	Cross-Connect
Splice Capacity (Maximum)	96 CT. Single Fusion	48 CT. Single Fusion
Number of Splice Trays (Maximum)	4 Low Profile	2 Low Profile
Adapter Port Quantity (Maximum)	Not Available	24 SC (Duplex) or 48 LC (Quad)
Indoor Cable Ports <sup>1, 3</sup>	7	
Outdoor Cable Ports <sup>2, 3</sup>	3	
Cable Diameters	0.07" – 0.12" (1.8 mm – 3.0 mm) & 0.14" – 0.51" (3.6 mm – 13.0 mm)	
Configuration	In-Line or Butt	
Application	Wall or Pole Mount	
Ingress Protection	IP-65	
Flame Protection	V0	
Size	11.6" L x 7.4" W x 4.2" H (295 x 187 x 106 mm)	

<sup>1</sup> Cable ports located on all sides of the wall box can be used for indoor applications.

<sup>2</sup> Cable ports located at bottom of the wall box can only be used for outdoor applications.

<sup>3</sup> Multi-hole grommets allow for more than one cable to enter each cable port.

## Components

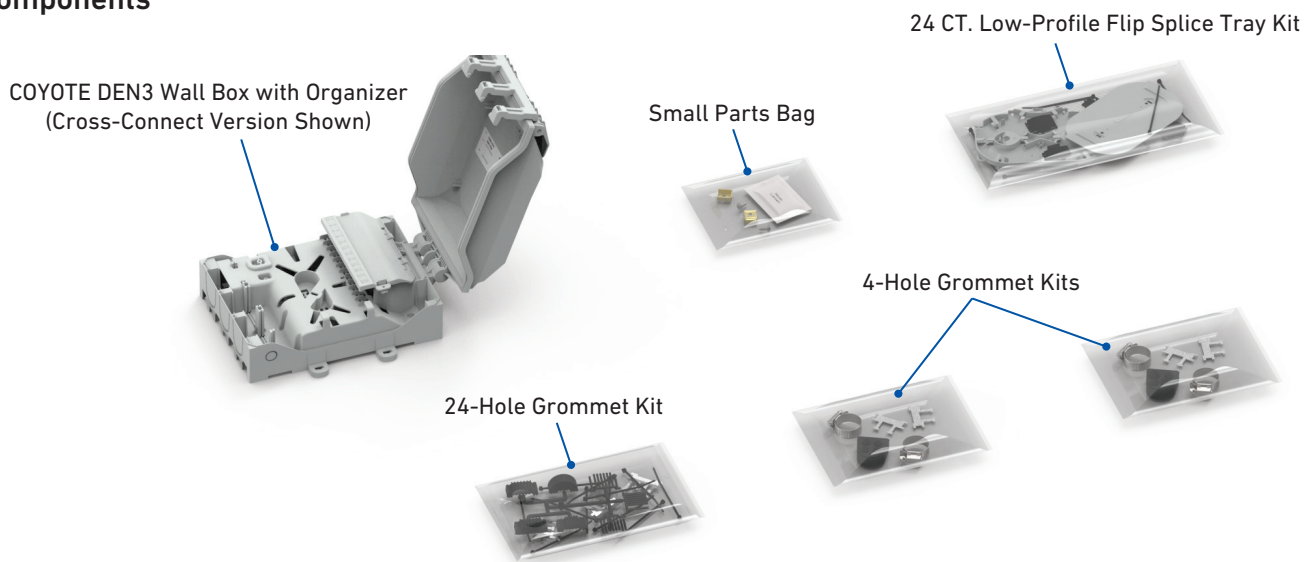

## COYOTE DEN3 Wall Box Kits

Catalog Number	Description
COYDEN3-SPL	COYOTE DEN3 Wall Box with Direct Splice Organizer – Includes (4) COYOTE DEN 24 CT. Low-Profile Flip Splice Tray Kits, (1) 4-Hole Grommet Kit: (4 Holes) 0.30" – 0.38" (7.6 – 9.7 mm), (1) 4-Hole Grommet Kit: (2 Holes) 0.38" – 0.46" (9.7 – 11.7 mm) & (2 Holes) 0.46" – 0.51" (11.7 – 13.0 mm), (1) 24-Hole Grommet Kit: (24 Holes) 0.07" – 0.12" (1.8 – 3.0 mm), & (1) Small Parts Bag
COYDEN3-XC	COYOTE DEN3 Wall Box with Cross-Connect Organizer – Includes (2) COYOTE DEN 24 CT. Low-Profile Flip Splice Tray Kits, (1) 4-Hole Grommet Kit: (4 Holes) 0.30" – 0.38" (7.6 – 9.7 mm), (1) 4-Hole Grommet Kit: (2 Holes) 0.38" – 0.46" (9.7 – 11.7 mm) & (2 Holes) 0.46" – 0.51" (11.7 – 13.0 mm), (1) 24-Hole Grommet Kit: (24 Holes) 0.07" – 0.12" (1.8 – 3.0 mm), & (1) Small Parts Bag



## COYOTE® DEN5 FOR DIRECT SPLICE APPLICATIONS

### Specifications

Catalog Number	COYDEN5-SPL
Application	Direct Splice
Splice Capacity (Maximum)	96 CT. Single Fusion
Number of Splice Trays (Maximum)	4 Deep Profile
Indoor Cable Ports <sup>1,3</sup>	9
Outdoor Cable Ports <sup>2,3</sup>	5
Cable Diameters	0.07" – 0.12" (1.8 mm – 3.0 mm) & 0.14" – 0.51" (3.6 mm – 13.0 mm)
Configuration	In-Line or Butt
Application	Wall or Pole Mount
Ingress Protection	IP-65
Flame Protection	V0
Size	16.8" L x 11.4" W x 5.2" H (427 x 290 x 132 mm)

<sup>1</sup> Cable ports located on all sides of the wall box can be used for indoor applications.

<sup>2</sup> Cable ports located at bottom of the wall box can only be used for outdoor applications.

<sup>3</sup> Multi-hole grommets allow for more than one cable to enter each cable port.

### Components

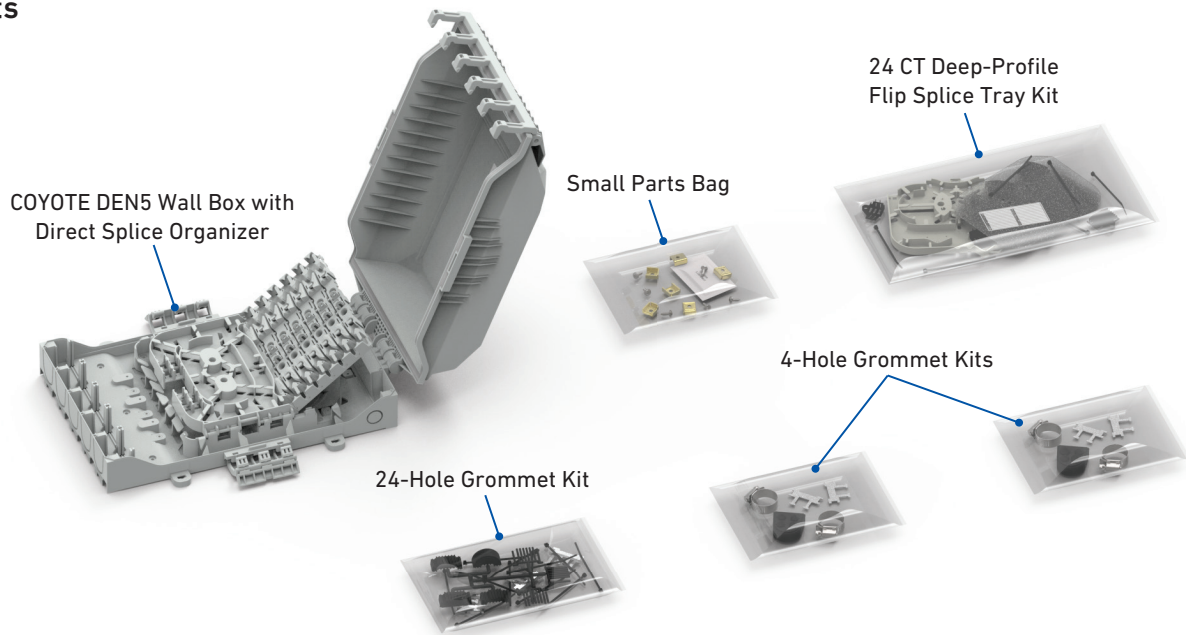

### COYOTE DEN5 Wall Box Kit for Direct Splice Applications

Catalog Number	Description
COYDEN5-SPL	COYOTE DEN5 Wall Box with Direct Splice Organizer – Includes (4) COYOTE DEN 24 CT. Deep Profile Flip Splice Tray Kits, (1) 4-Hole Grommet Kit: (2 Holes) 0.38" – 0.46" (9.7 – 11.7 mm) & (2 Holes) 0.46" – 0.51" (11.7 – 13.0 mm), (1) 24-Hole Grommet Kit: (24 Holes) 0.07" – 0.12" (1.8 – 3.0 mm), & (1) Small Parts Bag

# COYOTE® DEN5 FOR CROSS-CONNECT APPLICATIONS

## Specifications

Catalog Number	COYDEN5-CSTE2	COYDEN5-CSTE4
Application	Cross-Connect	
Splice Capacity (Maximum)	48 CT. Single Fusion	96 CT. Single Fusion
Number of Cassettes (Maximum)	2	4
Adapter Port Quantity (Maximum)	24 SC (Simplex) or 48 LC (Duplex)	48 SC (Simplex) or 96 LC (Duplex)
Indoor Cable Ports <sup>1,3</sup>	9	
Outdoor Cable Ports <sup>2,3</sup>	5	
Cable Diameters	0.07" – 0.12" (1.8 mm – 3.0 mm) & 0.14" – 0.51" (3.6 mm – 13.0 mm)	
Configuration	In-Line or Butt	
Application	Wall or Pole Mount	
Ingress Protection	IP-65	
Flame Protection	V0	
Size	16.8" L x 11.4" W x 5.2" H (427 x 290 x 132 mm)	

<sup>1</sup> Cable ports located on all sides of the wall box can be used for indoor applications.

<sup>2</sup> Cable ports located at bottom of the wall box can only be used for outdoor applications.

<sup>3</sup> Multi-hole grommets allow for more than one cable to enter each cable port.

## Components

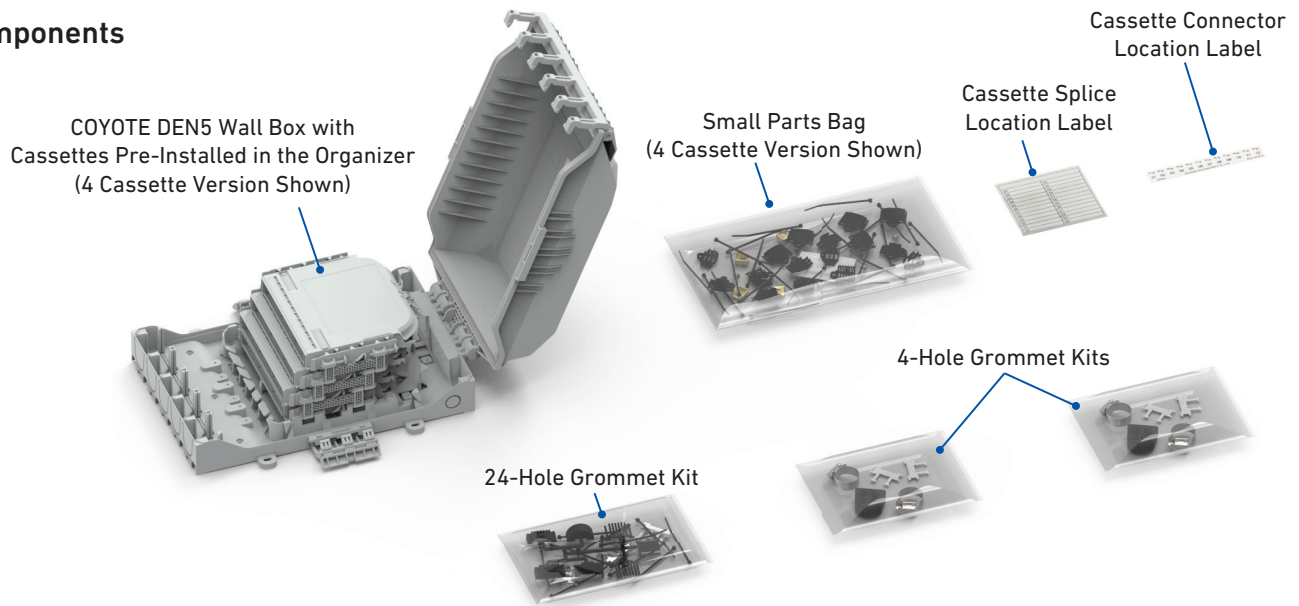

## COYOTE DEN5 Wall Box Kits for Cross-Connect Applications

Catalog Number	Description
COYDEN5-CSTE2	COYOTE DEN5 Wall Box with 2 Cassette Trays – Includes (2) Cassette Splice Location Labels, (2) Cassette Connector Location Labels, (1) 4-Hole Grommet Kit: (2 Holes) 0.38" – 0.46" (9.7 – 11.7 mm) & (2 Holes) 0.46" – 0.51" (11.7 – 13.0 mm), (2) 24-Hole Grommet Kit: (24 Holes) 0.07" – 0.12" (1.8 – 3.0 mm), & (1) Small Parts Bag
COYDEN5-CSTE4	COYOTE DEN5 Wall Box with 4 Cassette Trays – Includes (4) Cassette Splice Location Labels, (4) Cassette Connector Location Labels, (1) 4-Hole Grommet Kit: (2 Holes) 0.38" – 0.46" (9.7 – 11.7 mm) & (2 Holes) 0.46" – 0.51" (11.7 – 13.0 mm), (2) 24-Hole Grommet Kit: (24 Holes) 0.07" – 0.12" (1.8 – 3.0 mm), & (1) Small Parts Bag

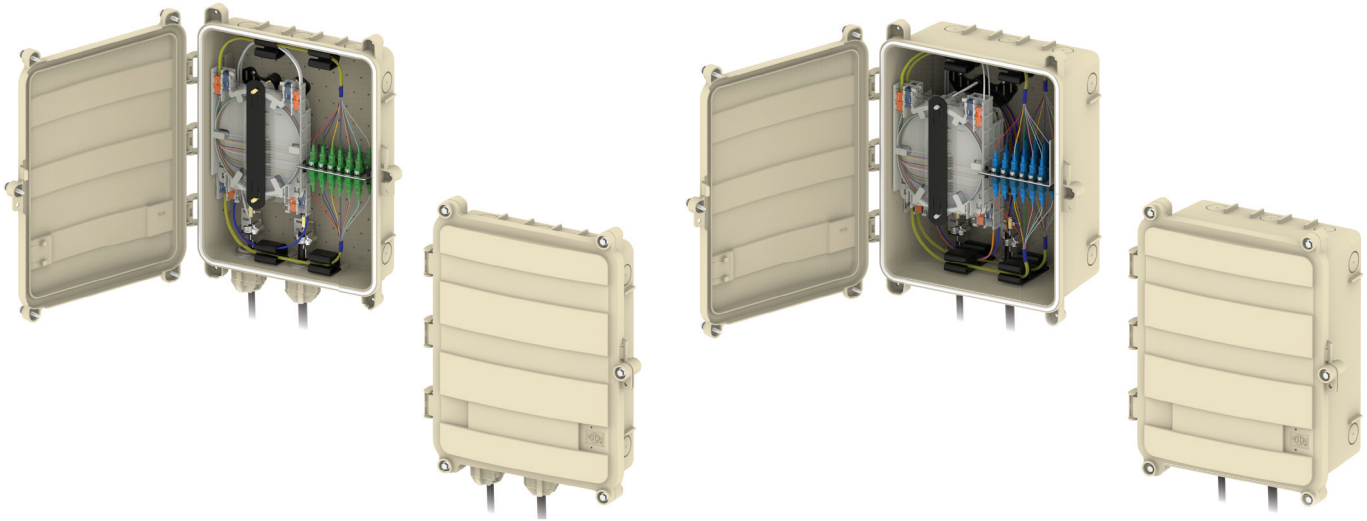

## COYOTE<sup>®</sup> MPC

The **COYOTE MPC (Multi-Purpose Closure)** is constructed of durable, UV stabilized, flame retardant polymer to permit interior or exterior applications. Eight cable entrance ports around the exterior accept an easy-to-use grommet system and standard commercially available fittings. The closure's interior can be configured to address slack storage, splicing, cross-connect, hardened adapter applications or any combination. Pre-terminated configurations are also available to minimize the amount of labor required during installation.

### FEATURES AND BENEFITS

- Interior grid hole pattern allows custom organization of various components
- Offers NEMA4 performance
- Constructed with UL94-5VA rated polymer compounds, to provide the highest flame resistant rating
- Flexible grommet sealing technology supports a wide range of flat and round cable profiles
- Integrated silicone foam rubber gasket designed to eliminate water entry
- 8 cable entrance ports around closure exterior

# COYOTE® STANDARD MPC

## Specifications

<b>Catalog Numbers</b>	<b>COYMPC-000, COYMPC-001, COYMPC-002, COYMPC-004, COYMPC-005, COYMPC-006</b>
Splice Capacity (Maximum) – Single Fusion (Low Profile, 80809958), Single Fusion (Low Profile, 80813152), Single Fusion (Deep Profile, 80808945), Mass Fusion (Deep Profile, LGSTR144)	96, 144, 80, 288
Number of Splice Trays – 80809958, 80813152, 80808945, LGSTR144	4, 4, 2, 2
Cable Ports <sup>1</sup>	8
Cable Diameters	0.093" – 1.00" (2.4 mm – 25.4 mm)
Configuration	In-Line or Butt
Application	Pole/Wall
Ingress Protection	In accordance with Telcordia® GR-771-CORE, NEMA4, IP-66
Size <sup>2</sup>	17.5" L x 14.4" W x 4.0" D (445 x 366 x 102 mm)

<sup>1</sup> Multi-hole grommets allow for more than one cable to enter each cable port.  
<sup>2</sup> Outermost part of the assembly

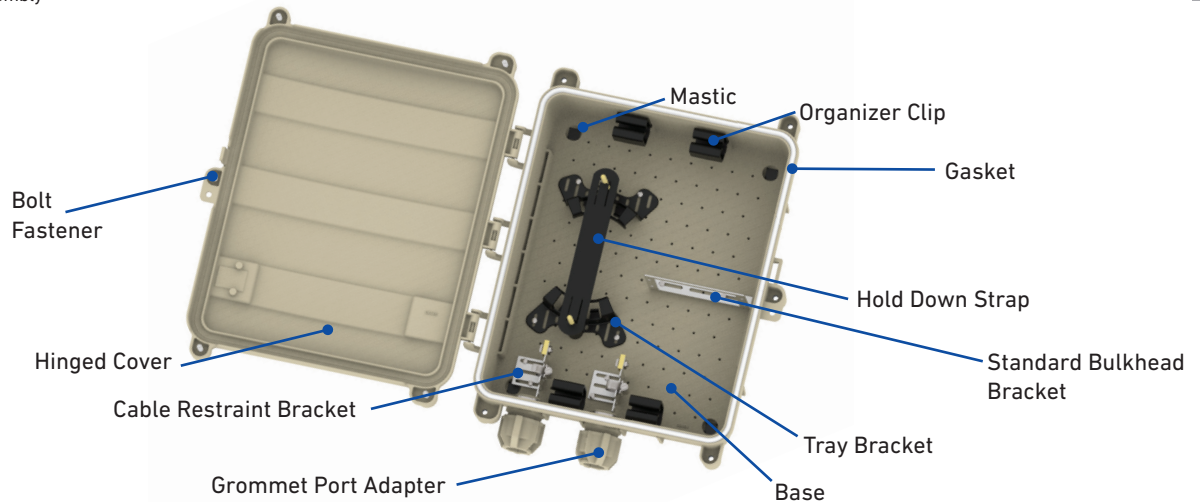

## COYOTE Standard MPC Kits

Catalog Number	Description
COYMPC-000	COYOTE Standard MPC – Empty
COYMPC-001	COYOTE Standard MPC – Includes (1) 4-Hole Grommet Port Adapter Kit 0.120" – 0.275" (3.0 – 7.0 mm), and (1) Organizer Clip Kit
COYMPC-002	COYOTE Standard MPC for OptiTap® Adapters – Includes (1) 4-Hole Grommet Port Adapter Kit 0.120" – 0.275" (3.0 – 7.0 mm), (1) 8-Hole Grommet Port Adapter Kit 0.120" – 0.200" (3.0 – 5.1 mm), (1) Bulkhead with 2 OptiTap Adapters, (1) Organizer Clip Kit, (1) Storage Bracket Kit, and (1) Grommet Port Adapter Shroud
COYMPC-004	COYOTE Standard MPC – Includes (1) 4-Hole Grommet Port Adapter Kit 0.120" – 0.275" (3.0 – 7.0 mm), (1) 2-Hole Grommet Port Adapter 0.275" – 0.50" (7.0 – 12.7 mm), (2) Organizer Clip Kit, (2) Cable Restraint Brackets, (2) Tray Brackets, and (1) Standard Short Splice Tray – 12 Splice CT.
COYMPC-005	COYOTE Standard MPC – Includes (3) 4-Hole Grommet Port Adapter Kit 0.120" – 0.275" (3.0 – 7.0 mm), (1) 1-Hole Grommet Port Adapter Kit 0.40" – 0.60" (10.2 – 15.2 mm), (2) 6 SC/UPC Adapter Plates, (2) Organizer Clip Kit, and (4) Cable Restraint Brackets
COYMPC-006	COYOTE Standard MPC – Includes (1) 1-Hole Grommet Port Adapter Kit 0.40" – 0.60" (10.2 – 15.2 mm), (2) Organizer Clip Kit, (1) Cable Restraint Bracket, (1) LITE-GRIP® Short Splice Tray – 16 Splice CT., and (1) Splice Tray Support Kit

OptiTap® is a registered trademark of Corning Cable Systems.

Telcordia® is a registered trademark of Telcordia Technologies, Inc., now part of Ericsson.  
 CO-CA-1004-20



## COYOTE® DEEP MPC

### Specifications

<b>Catalog Numbers</b>	<b>COYMPC-D000, COYMPC-D001, COYMPC-D005</b>
Splice Capacity (Maximum) – Single Fusion (Low Profile, 80809958), Single Fusion (Low Profile, 80813152), Single Fusion (Deep Profile, 80808945), Mass Fusion (Deep Profile, LGSTR144)	288, 432, 240, 864
Number of Splice Trays – 80809958, 80813152, 80808945, LGSTR144	12, 12, 6, 6
Cable Ports <sup>1</sup>	8
Cable Diameters	0.093" – 1.00" (2.4 mm – 25.4 mm)
Configuration	In-Line or Butt
Application	Pole/Wall
Ingress Protection	In accordance with Telcordia® GR-771-CORE, NEMA4, IP-66
Size <sup>2</sup>	17.5" L x 14.4" W x 7.0" D (445 x 366 x 178 mm)

<sup>1</sup> Multi-hole grommets allow for more than one cable to enter each cable port.

<sup>2</sup> Outermost part of the assembly

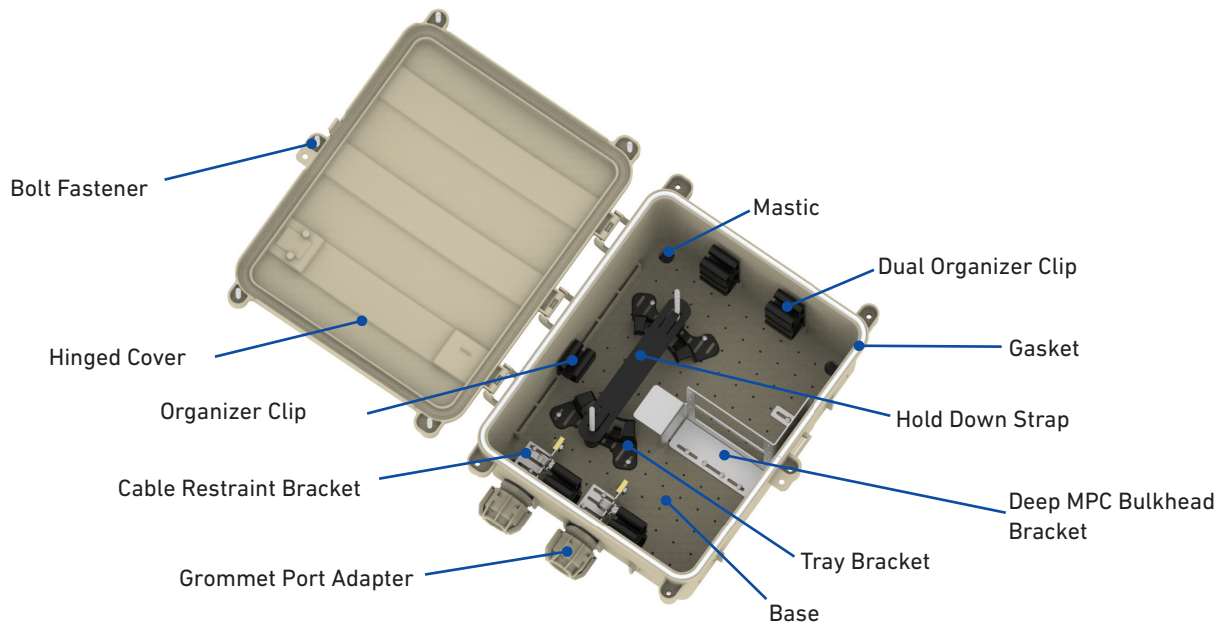

### COYOTE Deep MPC Kits

Catalog Number	Description
COYMPC-D000	COYOTE Deep MPC – Empty
COYMPC-D001	COYOTE Deep MPC – Includes (1) 4-Hole Grommet Port Adapter Kit 0.120" – 0.275" (3.0 – 7.0 mm), (1) Cable Restraint Bracket and (2) Dual Organizer Clip Kits
COYMPC-D005	COYOTE Deep MPC – Includes (1) 1-Hole Grommet Port Adapter Kit 0.40" – 0.60" (10.2 – 15.2 mm), (3) 4-Hole Grommet Port Adapter Kit 0.120" – 0.275" (3.0 – 7.0 mm), (1) Splice Tray Support Kit, (1) Deep MPC Bulkhead Kit, (2) 6 SC/UPC Adapter Plates, (4) Cable Restraint Brackets and (2) Dual Organizer Clip Kits

## ACCESSORIES

### COYOTE MPC Grommet Port Adapter Kits

Catalog Number	Description
8003827	1-Hole Grommet Port Adapter 0.40" – 0.60" (10.2 mm – 15.2 mm)
8003826	1-Hole Grommet Port Adapter 0.60" – 0.825" (15.2 mm – 21.0 mm)
8003825	1-Hole Grommet Port Adapter 0.825" – 1.00" (21.0 mm – 25.4 mm)
8003828	2-Hole Grommet Port Adapter 0.275" – 0.500" (7.0 mm – 12.7 mm)
8003812	4-Hole Grommet Port Adapter 0.120" – 0.275" (3.0 mm – 7.0 mm)
8003818	8-Hole Grommet Port Adapter 0.120" – 0.200" (3.0 mm – 5.1 mm)
80808618	Stepped Grommet Kit 0.070" – 1.00" (1.8 mm – 25.4 mm)

### COYOTE Standard and Deep MPC Accessories

Catalog Number	Description
80809958	Splice Tray, COYOTE LITE-GRIP® Short, Low Profile, 24 CT., Single Fusion
80813152	Splice Tray, COYOTE LITE-GRIP Short, Low Profile, 36 CT., Single Fusion
80808945	Splice Tray, COYOTE LITE-GRIP Short, Deep Profile, 40 CT., Single Fusion
LGSTR144	Splice Tray, COYOTE LITE-GRIP Short, Deep Profile, 144 CT., Mass Fusion
8003813	Organizer Clip Kit – Includes (3) Clips
8003811	Storage Bracket Kit – Includes (2) Brackets
80808853	Splice Tray Support Kit – Includes (2) Tray Brackets, (1) Hold Down Strap, (4) Nylon Cable Clamps, and (1) Felt Strip
8003829	Cable Restraint Bracket Kit – Includes (1) Restraint Bracket
80808508	OptiTap® 2-Port Internal Bracket Kit – Includes (2) Adapters
8003824	OptiTap 8-Port Internal Bracket Kit – Does NOT Include Adapters
80808916	Empty Bulkhead Kit – Accepts 2 Adapter Modules
80808982	Pole/Wall Mounting Bracket

### COYOTE Deep MPC Accessories

Catalog Number	Description
8003870	Dual Organizer Clip Kit – Includes (3) Clips
80808960	Empty Bulkhead Kit – Accepts 4 Adapter Modules

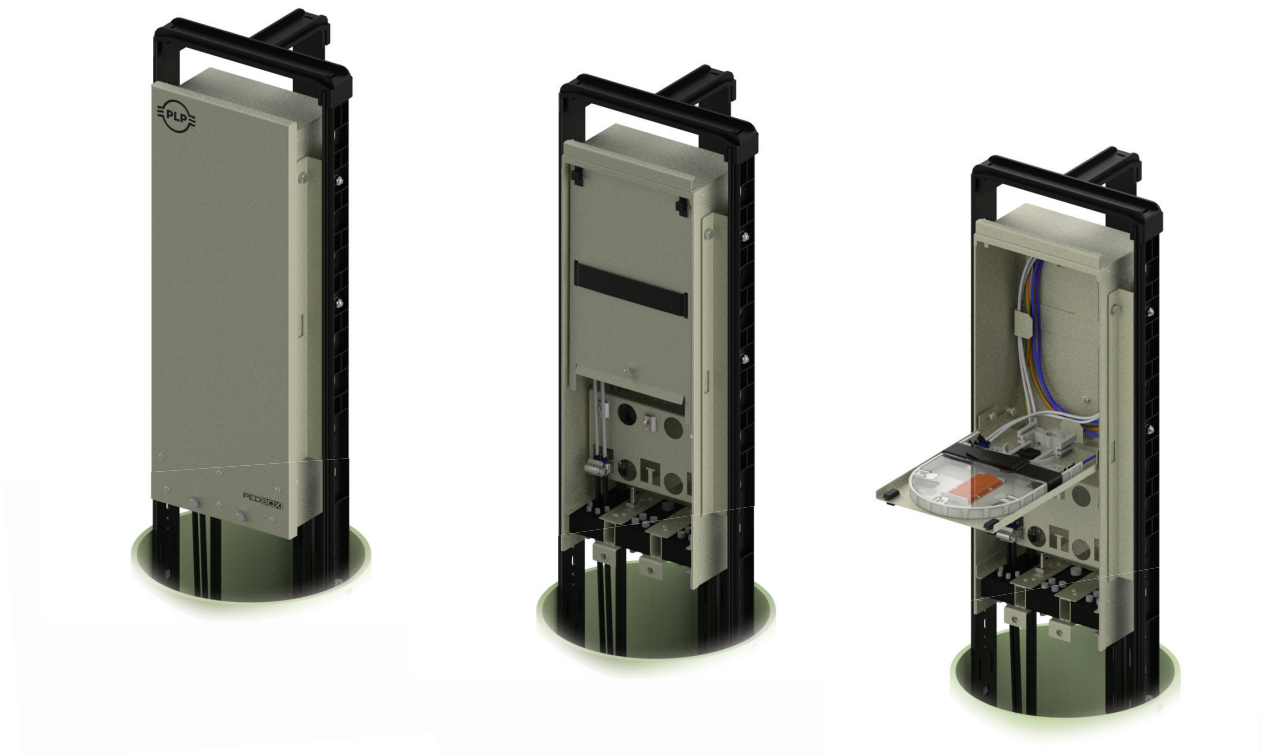

## COYOTE® PEDBOX®

The **COYOTE PedBox** is an outdoor distribution splice enclosure that can be mounted inside a pedestal. The flexible pre-slit silicone grommets allow for easy installation for a wide range of flat and round cables in any weather condition. The splice platform can be removed to allow access to slack storage or to move away from the pedestal. The base comes with a ground stud for common bonding practices. The included mounting bracket allows the closure to be mounted on the side or back of a 10" or larger pedestal.

### FEATURES AND BENEFITS

- Pre-slit silicone grommets allow for easy installation in any weather condition
- Flexible grommet technology supports a wide range of flat and round cable profiles
- Removable splice platform allows splice trays to be moved from the pedestal to a more suitable working environment
- When in a stored state, the splice trays are protected by the splice platform as it provides an additional layer of security when the pedestal cover is removed
- Can be mounted COYOTE 8" Pedestal or other 10" or larger pedestals
- Included pedestal mounting bracket can be attached to side or back
- Aluzinc powder-coated metal enhances corrosion resistance, offering more protection than traditional powder-coated steel

## COYOTE PEDBOX

### Specifications

<b>Catalog Number</b>	<b>80061728, 80061729</b>
Splice Capacity (Maximum): Single Fusion/Mass Fusion (Thin Profile, 80814403), Single Fusion/Mass Fusion (Deep Profile, 80814404)	108 SF/288 MF  36 SF/144 MF
Number of Splice Trays – 80814403 <sup>1</sup> , 80814404	3, 1
Cable Ports <sup>2</sup>	6
Cable Diameters	0.137" – 1.024" (3.5 mm – 26.0 mm) and Flat Drop
Ground Studs	1
Configuration	Butt
Application	Pedestal
Size	19.1" x 7.0" x 4.2" (486 mm x 180 mm x 105 mm)

<sup>1</sup> The 80814403 thin-profile splice tray can only be used for cables that contain SpiderWeb Ribbon (SWR®) - AFL, Rollable Ribbon (RR) - OFS, Pliable Ribbon - Sumitomo, or FlexRibbon™ - Prysmian

<sup>2</sup> Multi-hole grommets allow for more than one cable to enter each cable port.

## COMPONENTS

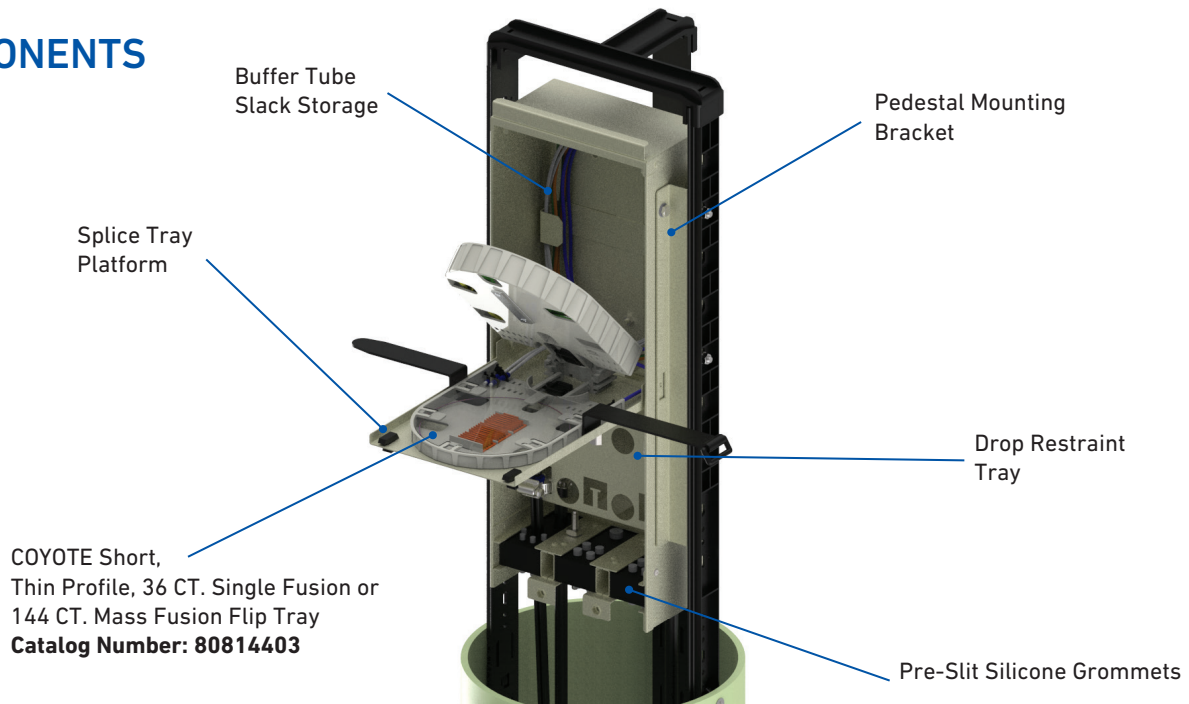

### PedBox Closure Kits

Catalog Number	Description
80061728	COYOTE PedBox – Includes (2) 1-Hole Grommets 0.393" - 0.523", (3) 1-Hole Grommets 0.524" - 0.649", (1) 6-Hole Grommet 0.137" - 0.256" & Flat Drop Cable, and (1) Thin Profile Flip Tray, 36 CT. Single Fusion or 144 CT. Mass Fusion
80061729	COYOTE PedBox – Includes (3) 1-Hole Grommets 0.393" - 0.523", (2) 4-Hole Grommets 0.296" - 0.394", (1) 6-Hole Grommet 0.137" - 0.256" & Flat Drop Cable, and (1) Thin Profile Flip Tray, 36 CT. Single Fusion or 144 CT. Mass Fusion

All kits include (1) COYOTE PedBox Assembly, (1) Pedestal Mounting Bracket and Cable Restraint Hardware

SWR® is a registered trademark of AFL. FlexRibbon™ is a registered trademark of Prysmian.

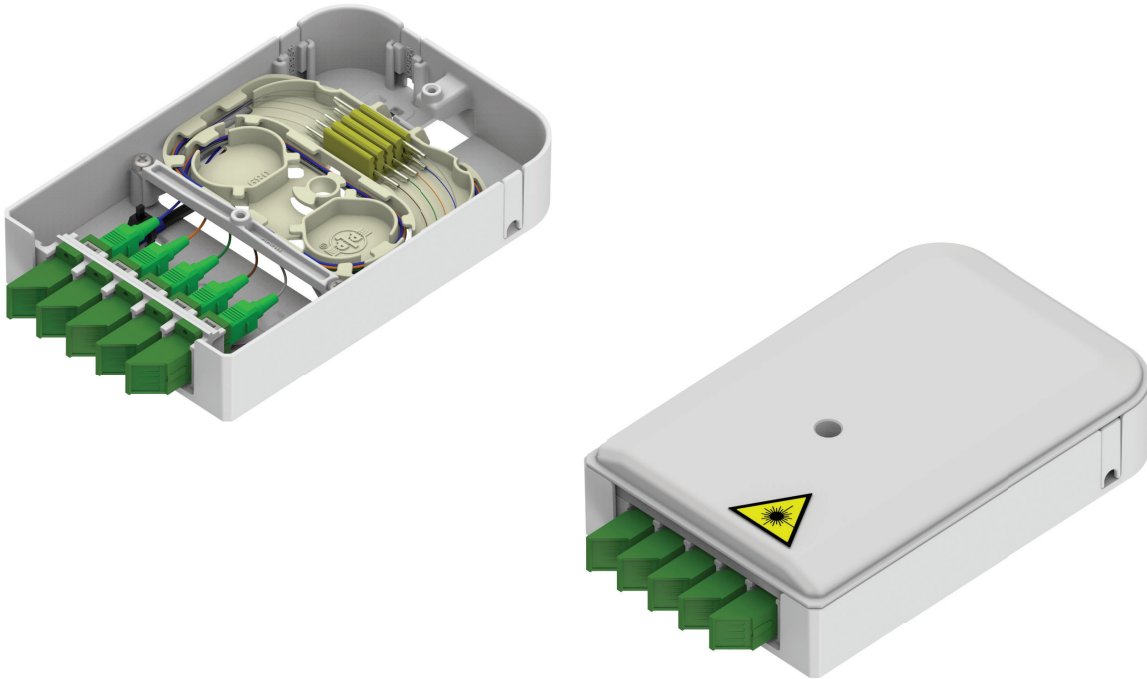

## COYOTE<sup>®</sup> ACE

The **COYOTE ACE (Adaptable Connection Enclosure)** offers the greatest flexibility to address the multitude of connection options required to support home and office networks. Interchangeable inserts allow the enclosure to be configured to support fiber/coax applications, fiber/CAT6 applications, Coax/CAT6 application, coax only applications and fiber only applications. The enclosure can be used in conjunction with the COYOTE Fiber Wall Plates to support additional fiber slack storage or applications requiring 1x4 coax splitters. Each COYOTE ACE is produced from flame retardant compounds.

### FEATURES AND BENEFITS

- Supports splice/patch applications and multiple connection types
- Accepts industry standard adapters and coax splitters
- Fiber entrance slots on side and top of base for surface mount applications using raceway
- Large opening in back wall of base to support transition of fiber or coax when mounted to an electrical outlet box
- Can be combined with the COYOTE Access Solutions™ Fiber Wall Plate to provide additional slack storage or address fiber with coax splitter applications
- Flame retardant

## COYOTE® ACE

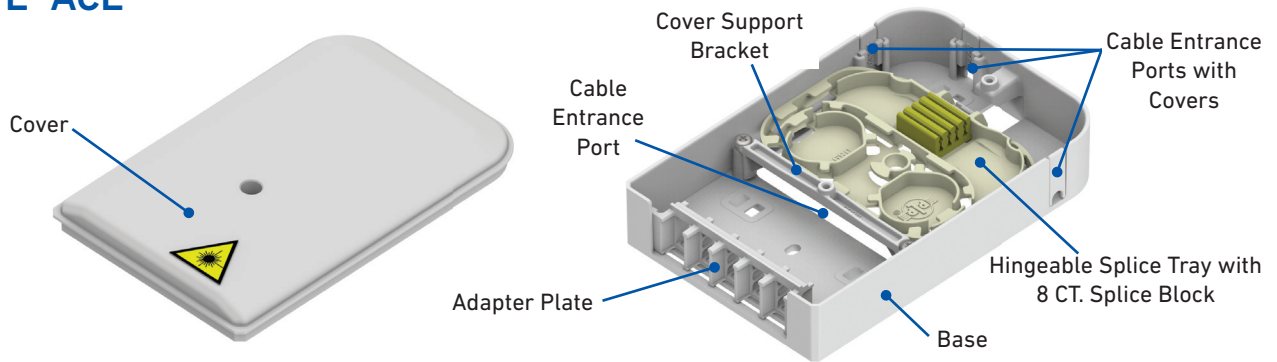

### Specifications

Catalog Numbers	COYACE-001 through COYACE-008
Splice Capacity (Maximum) – Single Fusion	8
Adapter Port Quantity (Maximum)	(5) SC, (10) LC, (1) 1x2, 1x3, or 1x4 Coax Splitter, (2) CAT5, CAT6, RJ11, RJ45, or Coax Adapters
Adapter Plate Configurations	(5) Fiber Adapters, (3) Fiber Adapters and (1) Ethernet or Coax Adapter, (1) Fiber Adapter and (2) Ethernet or Coax Adapter, (1) Fiber Adapter and (1) 1x2 Coax Splitter, (1) Ethernet or Coax Adapter and (1) 1x2 Coax Splitter, or (1) 1x3 or 1x4 Coax Splitter
Colors	White
Cable Entrance Ports	(1) Top Edge, (1) Left Edge, (1) Right Edge, and (1) Back of Base
Size	4" W x 6" L x 1" D (102 x 152 x 25 mm)

### COYOTE ACE Kit Contents

Catalog Numbers	Description
COYACE-000	COYOTE ACE – Includes (1) Base, (1) Cover, (5) Empty Adapter Plates, (3) Port Covers, and Mounting Hardware
COYACE-001	COYOTE ACE – Includes (1) Splice Tray Kit and (2) SC/APC Shuttered Adapters and Pigtailed
COYACE-002	COYOTE ACE – Includes (1) Splice Tray Kit and (5) SC/APC Shuttered Adapters and Pigtailed
COYACE-003	COYOTE ACE – Includes (1) Splice Tray Kit and (2) SC/UPC Shuttered Adapters and Pigtailed
COYACE-004	COYOTE ACE – Includes (1) Splice Tray Kit and (5) SC/UPC Shuttered Adapters and Pigtailed
COYACE-005	COYOTE ACE – Includes (1) CAT6 Adapter, (1) Coax Adapter, and (1) SC/APC Shuttered Adapter
COYACE-006	COYOTE ACE – Includes (1) Coax Adapter and (1) SC/APC Shuttered Adapter
COYACE-007	COYOTE ACE – Includes (1) SC/APC Shuttered Adapter
COYACE-008	COYOTE ACE – Includes (1) Splice Tray Kit and (1) SC/APC Shuttered Adapters and Pigtailed

All kits include (1) Base, (1) Cover, (5) Empty Adapter Plates, (3) Port Covers and Mounting Hardware

### COYOTE ACE Accessories

Catalog Numbers	Description
8004034	Splice Tray Kit – Includes (1) Splice Tray and (1) Splice Block
80811215	Adapter Kit – Includes (2) SC/APC Shuttered Adapters
80811216	Adapter Kit – Includes (3) SC/APC Shuttered Adapters
80813611	Adapter Kit – Includes (2) LC/APC Shuttered Adapters
80813612	Adapter Kit – Includes (3) LC/APC Shuttered Adapters
800014114	Adapter Kit – Includes (2) SC/UPC Shuttered Adapters
800014115	Adapter Kit – Includes (3) SC/UPC Shuttered Adapters
80813613	Adapter Kit – Includes (2) LC/UPC Shuttered Adapters
80813614	Adapter Kit – Includes (3) LC/UPC Shuttered Adapters
800013979	Pigtail Kit – Includes (2) SC/APC 900 $\mu$ m Pigtailed
800013980	Pigtail Kit – Includes (3) SC/APC 900 $\mu$ m Pigtailed
800014109	Pigtail Kit – Includes (2) SC/UPC 900 $\mu$ m Pigtailed
800014110	Pigtail Kit – Includes (3) SC/UPC 900 $\mu$ m Pigtailed
80811135	CAT6 Jack
80812152	Coax Jack

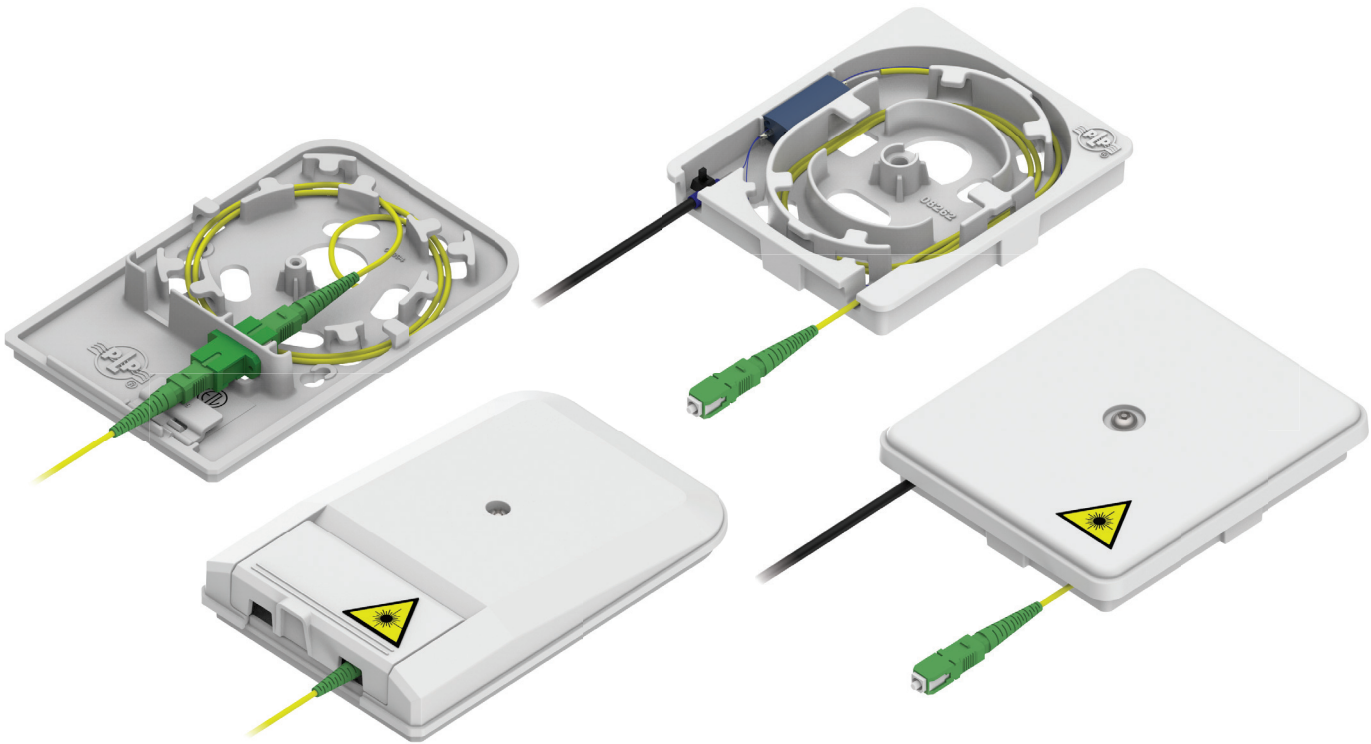

## COYOTE® ACCESS SOLUTIONS™ FIBER WALL PLATES

The **COYOTE Access Solutions Fiber Wall Plates** are compact fiber organizers used to create a fiber demarcation point inside the home, office, or apartment. Internal fiber routing features control bend radius and allows for slack storage outside of the wall cavity. Specific designs also provide for splicing inside the wall plate. Each wall plate is produced from flame retardant compounds, is easy to install and is capable of being mounted directly to a standard electrical junction box or a wall.

### FEATURES AND BENEFITS

#### Fiber Wall Plate

- Designed to store a pre-connectorized pigtail for connection to a mating adapter
- Mounts to standard electrical junction boxes or wall
- Internal fiber routing provides bend radius control
- Hinged door provides open access for easy fiber connection or removal
- Internal adapter with automatic shutter provides protection from laser light output
- Flame retardant

#### Splice & Store Fiber Wall Plate

- Designed for splicing and storing a pre-connectorized fiber pigtail
- Provides up to 8 ft (2430 mm) of 2 mm or 4 ft (1220 mm) of 3 mm jacketed fiber
- Fiber entrance ports through the back and bottom edge of the wall plate
- Flame retardant

## FIBER WALL PLATE

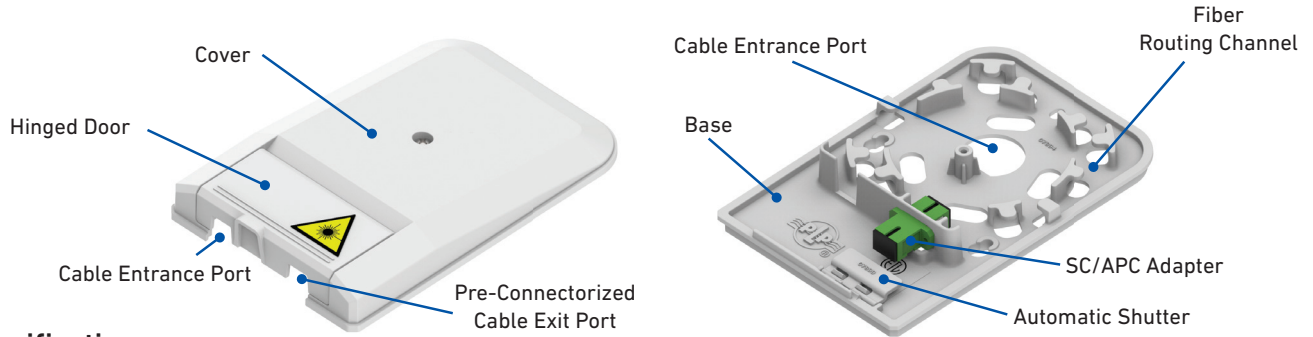

### Specifications

<b>Catalog Numbers</b>	<b>8006992W, 8006992IV</b>
Splice Capacity	0
Adapter Port Quantity (Maximum)	1 SC/APC (provided)
Colors	White and Almond
Cable Entrance Ports	(1) Bottom Edge and (1) Back of Base
Size	4" W x 6" L x 1" D (102 x 152 x 25 mm)

### COYOTE Fiber Wall Plate Kit Contents

Catalog Numbers	Description
8006992W	COYOTE Fiber Wall Plate in White – Includes (1) Base, (1) Cover, (1) SC/APC Factory Installed Adapter and (1) Mounting Hardware Kit
8006992IV	COYOTE Fiber Wall Plate in Almond – Includes (1) Base, (1) Cover, (1) SC/APC Factory Installed Adapter and (1) Mounting Hardware Kit

## SPLICE & STORE FIBER WALL PLATE

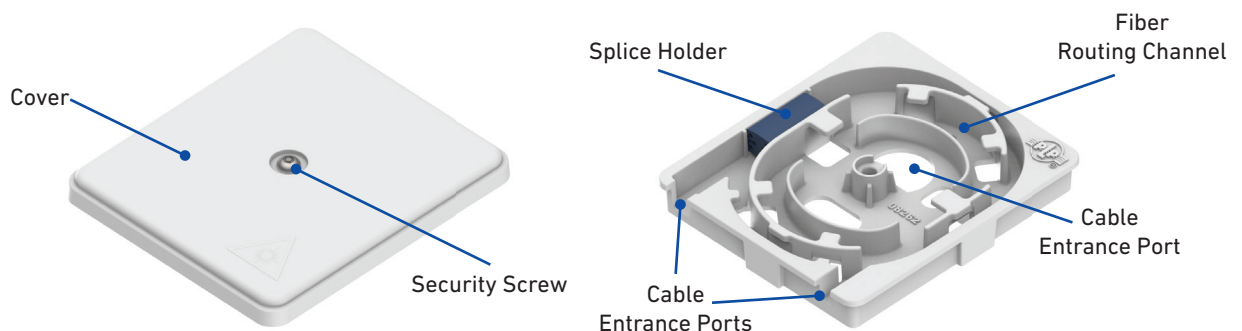

### Specifications

<b>Catalog Numbers</b>	<b>80061045</b>
Splice Capacity	1
Adapter Port Quantity (Maximum)	0
Colors	White
Cable Entrance Ports	(2) Bottom Edge and (1) Back of Base
Size	4.5" W x 5.0" L x 0.87" D (114 x 127 x 22 mm)

### COYOTE Fiber Wall Plate Kit Contents

Catalog Number	Description
80061045	COYOTE Splice & Store Fiber Wall Plate in White – Includes (1) Base, (1) Cover, (1) Blue LITE-GRIP® Retention Block, (1) Felt Strip, (2) Tie Wraps and (1) Security Screw

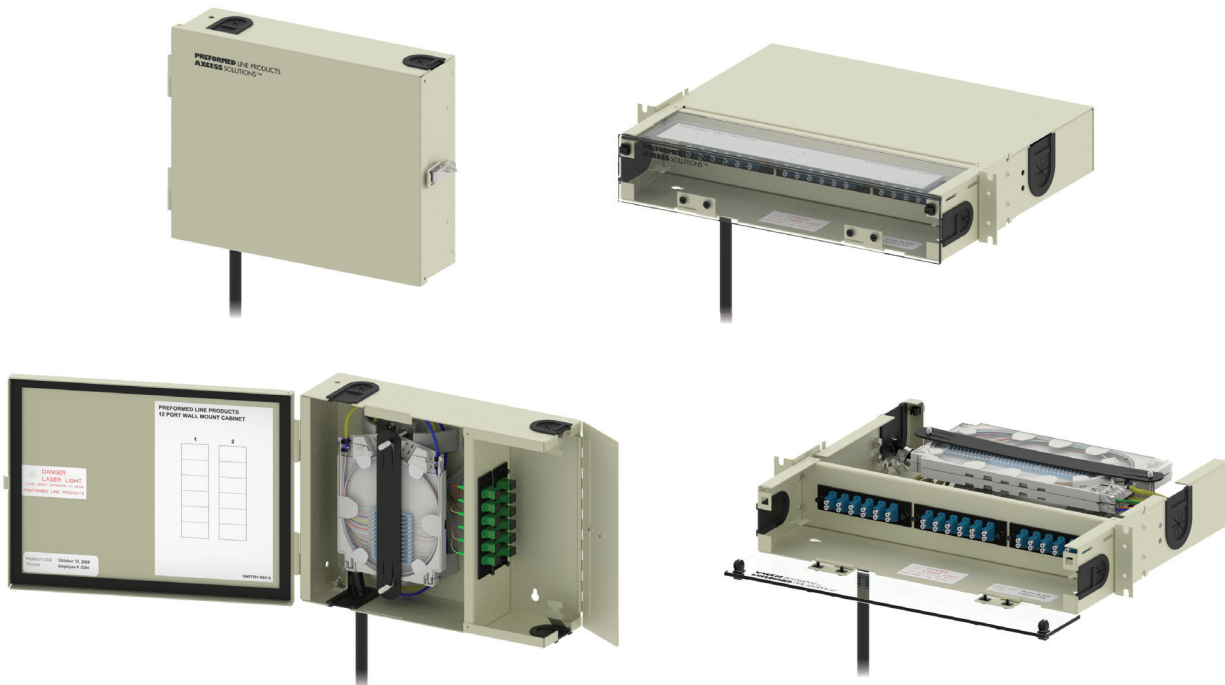

## COYOTE® ACCESS SOLUTIONS™ CABINETS

The **COYOTE Access Solutions Cabinets** are pre-assembled to your exact specifications to begin splicing right out of the carton, providing a substantial labor savings. Each cabinet is made from rugged 16 gauge steel and has a durable powder-coat finish that comes in almond or black. High-density splicing and patching can be achieved in one cabinet with the craft-friendly COYOTE splice trays and integrated fiber storage. Cabinets can be ordered with adapter modules (UPC or APC) and color coded pigtailed to match your application. All multi-mode fiber grades available.

### FEATURES AND BENEFITS

#### Wall Mount Cabinets

- Provides protected fiber splicing and connectivity
- Optional lock for inner door secures the splicing compartment
- Each cabinet may be ordered with adapter modules or pre-terminated with pigtailed to an exact specification
- Pre-terminated cabinets are 100% tested for optical insertion loss after assembly
- Installation and mounting hardware included

#### Rack Mount Cabinets

- Provides protected fiber splicing and connectivity
- Universal mounting bracket to fit 19" (482 mm) or 23" (584 mm) racks
- Each cabinet may be ordered with adapter modules or pre-terminated with pigtailed to an exact specification
- Pre-terminated cabinets are 100% tested for optical insertion loss after assembly
- Clear front door and access panels are removable for easy entry
- Lockable rear splicing compartment

## WALL MOUNT CABINETS



### Specifications: WDC2

Catalog Numbers	WDC2A <sup>1</sup> and WDC2B <sup>1</sup>
Splice Capacity (Maximum) – Single Fusion (Standard Profile, 80806033)	24
Number of Splice Trays – 80806033	2
Adapter Port Quantity (Maximum)	24 ST, 24 SC, or 24 LC
Colors	Almond or Black
Size <sup>2</sup>	10" H x 13" W x 3.5" D (254 x 330 x 89 mm)

<sup>1</sup> A for Almond or B for Black

<sup>2</sup> Outermost part of the assembly



### Specifications: WDC4

Catalog Numbers	WDC4A <sup>1</sup> and WDC4B <sup>1</sup>
Splice Capacity (Maximum) – Single Fusion (Low Profile, 8003468), Single Fusion (Standard Profile, 80806033),	48, 24
Number of Splice Trays – 8003468, 80806033	2, 2
Adapter Port Quantity (Maximum)	48 ST, 48 SC, or 48 LC
Colors	Almond or Black
Size <sup>2</sup>	14" H x 13" W x 3.5" D (356 x 330 x 89 mm)

<sup>1</sup> A for Almond or B for Black

<sup>2</sup> Outermost part of the assembly



### Specifications: WDC8

Catalog Numbers	WDC8A <sup>1</sup> and WDC8B <sup>1</sup>
Splice Capacity (Maximum) – Single Fusion (Low Profile, 8001127), Single Fusion (Standard Profile, 80805514)	96, 72
Number of Splice Trays – 8001127, 80805514	4, 3
Adapter Port Quantity (Maximum)	96 ST, 96 SC, or 96 LC
Colors	Almond or Black
Size <sup>2</sup>	17" H x 13" W x 5.5" D (432 x 330 x 140 mm)

<sup>1</sup> A for Almond or B for Black

<sup>2</sup> Outermost part of the assembly



### Specifications: WDC12

Catalog Numbers	WDC12A <sup>1</sup> and WDC12B <sup>1</sup>
Splice Capacity (Maximum) – Single Fusion (Low Profile, 8001127), Single Fusion (Standard Profile, 80805514)	144, 144
Number of Splice Trays – 8001127, 80805514	6, 6
Adapter Port Quantity (Maximum)	144 ST, 144 SC, or 144 LC
Colors	Almond or Black
Size <sup>2</sup>	22" H x 17" W x 6.1" D (559 x 432 x 155 mm)

<sup>1</sup> A for Almond or B for Black

<sup>2</sup> Outermost part of the assembly



## RACK MOUNT CABINETS

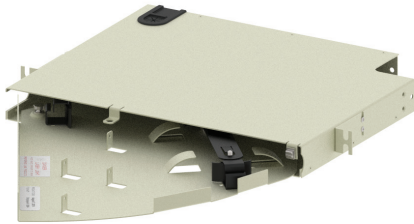

### Specifications: RDC2

Catalog Numbers	RDC2A <sup>1</sup> and RDC2B <sup>1</sup>
Splice Capacity (Maximum) – Single Fusion (Low Profile, 80809958), Single Fusion (Standard Profile, 80806033)	24, 12
Number of Splice Trays – 80809958, 80806033	1, 1
Adapter Port Quantity (Maximum)	24 ST, 24 SC, or 24 LC
Rack Units	1
Colors	Almond or Black
Size <sup>2</sup>	1.8" H x 17" W x 14" D (45 x 432 x 356 mm)

<sup>1</sup> A for Almond or B for Black

<sup>2</sup> Outermost part of the assembly

### Specifications: RDC3



Catalog Numbers	RDC3A <sup>1</sup> and RDC3B <sup>1</sup>
Splice Capacity (Maximum) – Single Fusion (Low Profile, 8001127), Single Fusion (Standard Profile, 80805514)	72, 48
Number of Splice Trays – 8001127, 80805514	3, 2
Adapter Port Quantity (Maximum)	36 ST, 36 SC, or 36 LC
Rack Units	2
Colors	Almond or Black
Size <sup>2</sup>	3.5" H x 17" W x 14" D (89 x 432 x 356 mm)

<sup>1</sup> A for Almond or B for Black

<sup>2</sup> Outermost part of the assembly

### Specifications: RDC6



Catalog Numbers	RDC6A <sup>1</sup> and RDC6B <sup>1</sup>
Splice Capacity (Maximum) – Single Fusion (Low Profile, 8001127), Single Fusion (Standard Profile, 80805514)	72, 48
Number of Splice Trays – 8001127, 80805514	3, 2
Adapter Port Quantity (Maximum)	72 ST, 72 SC, or 72 LC
Rack Units	2
Colors	Almond or Black
Size <sup>2</sup>	3.5" H x 17" W x 14" D (89 x 432 x 356 mm)

<sup>1</sup> A for Almond or B for Black

<sup>2</sup> Outermost part of the assembly

### Specifications: RDC12

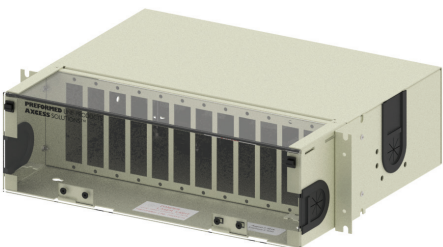

Catalog Numbers	RDC12A <sup>1</sup> and RDC12B <sup>1</sup>
Splice Capacity (Maximum) – Single Fusion (Low Profile, 8001127), Single Fusion (Standard Profile, 80805514)	144, 96
Number of Splice Trays – 8001127, 80805514	6, 4
Adapter Port Quantity (Maximum)	144 ST, 144 SC, or 144 LC
Rack Units	3
Colors	Almond or Black
Size <sup>2</sup>	5.3" H x 17" W x 14" D (134 x 432 x 356 mm)

<sup>1</sup> A for Almond or B for Black

<sup>2</sup> Outermost part of the assembly

## RACK MOUNT CABINETS

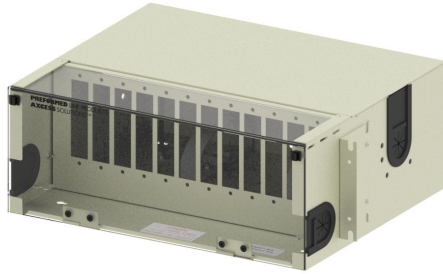

### Specifications: RDC12X

Catalog Numbers	RDC12XA <sup>1</sup> and RDC12XB <sup>1</sup>
Splice Capacity (Maximum) – Single Fusion (Low Profile, 8001127), Single Fusion (Standard Profile, 80805514)	144, 144
Number of Splice Trays – 8001127, 80805514	6, 6
Adapter Port Quantity (Maximum)	144 ST, 144 SC, or 144 LC
Rack Units	4
Colors	Almond or Black
Size <sup>2</sup>	6.7" H x 17" W x 14" D (170 x 432 x 356 mm)

<sup>1</sup> A for Almond or B for Black

<sup>2</sup> Outermost part of the assembly

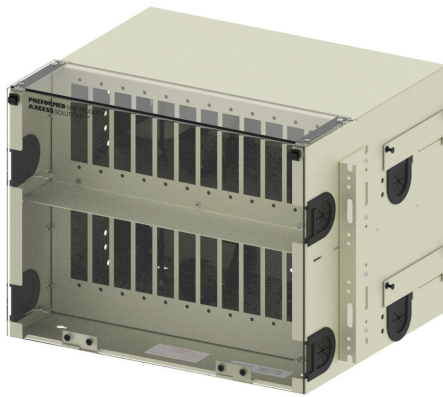

### Specifications: RDC24

Catalog Numbers	RDC24A <sup>1</sup> and RDC24B <sup>1</sup>
Splice Capacity (Maximum) – Single Fusion (Low Profile, 8001127), Single Fusion (Standard Profile, 80805514)	288, 240
Number of Splice Trays – 8001127, 80805514	12, 10
Adapter Port Quantity (Maximum)	288 ST, 288 SC, or 288 LC
Rack Units	8
Colors	Almond or Black
Size <sup>2</sup>	14" H x 17" W x 14" D (356 x 432 x 356 mm)

<sup>1</sup> A for Almond or B for Black

<sup>2</sup> Outermost part of the assembly



### Specifications: RDC36

Catalog Numbers	RDC36A <sup>1</sup> and RDC36B <sup>1</sup>
Splice Capacity (Maximum) – Single Fusion (Low Profile, 8001127), Single Fusion (Standard Profile, 80805514)	432, 360
Number of Splice Trays – 8001127, 80805514	18, 15
Adapter Port Quantity (Maximum)	432 ST, 432 SC, or 432 LC
Rack Units	12
Colors	Almond or Black
Size <sup>2</sup>	21" H x 17" W x 14" D (533 x 432 x 356 mm)

<sup>1</sup> A for Almond or B for Black

<sup>2</sup> Outermost part of the assembly

## OPTICAL COMPONENTS AND ACCESSORIES

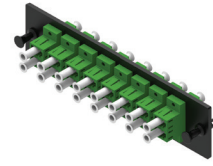
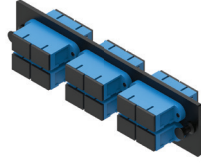
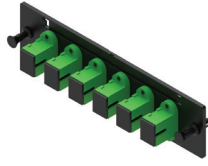
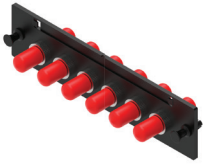

**6-Port ST Adapter Module    6-Port SC/APC Adapter Module    12-Port SC/UPC Adapter Module    16-Port LC/APC Adapter Module**

### COYOTE Adapter Modules

Catalog Number	Description
6SCAPC	Adapter Module Kit – Includes (1) 6-Port SC/APC Adapter Module
8SCAPC	Adapter Module Kit – Includes (1) 8-Port SC/APC Adapter Module
12SMDSCA	Adapter Module Kit – Includes (1) 12-Port SC/APC Adapter Module
6SMSC	Adapter Module Kit – Includes (1) 6-Port SC/UPC Adapter Module
8SMSC	Adapter Module Kit – Includes (1) 8-Port SC/UPC Adapter Module
12SMDSC	Adapter Module Kit – Includes (1) 12-Port SC/UPC Adapter Module
12SMLCA	Adapter Module Kit – Includes (1) 12-Port LC/APC Adapter Module
16SMLCA	Adapter Module Kit – Includes (1) 16-Port LC/APC Adapter Module
24LCAPC	Adapter Module Kit – Includes (1) 24-Port LC/APC Adapter Module
6SMLC	Adapter Module Kit – Includes (1) 6-Port LC/UPC Adapter Module
12SMLC	Adapter Module Kit – Includes (1) 12-Port LC/UPC Adapter Module
16SMLC	Adapter Module Kit – Includes (1) 16-Port LC/UPC Adapter Module
24SMLC	Adapter Module Kit – Includes (1) 24-Port LC/UPC Adapter Module
6SMST	Adapter Module Kit – Includes (1) 6-Port ST/UPC Adapter Module
8SMST	Adapter Module Kit – Includes (1) 8-Port ST/UPC Adapter Module
12SMST	Adapter Module Kit - Includes (1) 12-Port ST/UPC Adapter Module

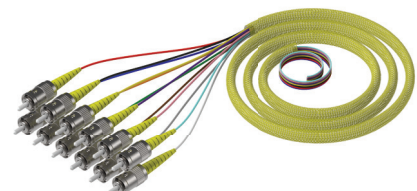
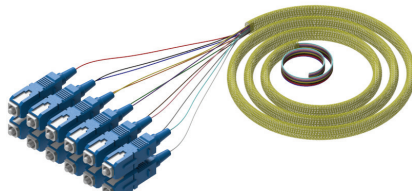
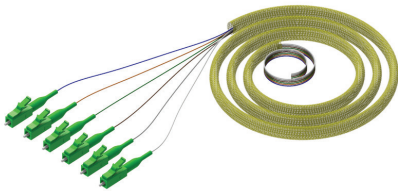

**6 Fiber LC/APC Pigtail Cable Assembly    12 Fiber SC/UPC Pigtail Cable Assembly    12 Fiber ST Pigtail Cable Assembly**

### COYOTE Fiber Pigtail Cable Assemblies

Catalog Number	Description
P6SCA3	3 Meter Pigtail Cable Assembly – Includes (6) Bundled SC/APC 900 µm Pigtails in Sleeving
P12SCA3	3 Meter Pigtail Cable Assembly – Includes (12) Bundled SC/APC 900 µm Pigtails in Sleeving
P6SCU3	3 Meter Pigtail Cable Assembly – Includes (6) Bundled SC/UPC 900 µm Pigtails in Sleeving
P12SCU3	3 Meter Pigtail Cable Assembly – Includes (12) Bundled SC/UPC 900 µm Pigtails in Sleeving
P6ST3	3 Meter Pigtail Cable Assembly – Includes (6) Bundled ST 900 µm Pigtails in Sleeving
P12ST3	3 Meter Pigtail Cable Assembly – Includes (12) Bundled ST 900 µm Pigtails in Sleeving
P6LCA3	3 Meter Pigtail Cable Assembly – Includes (6) Bundled LC/APC 900 µm Pigtails in Sleeving
P12LCA3	3 Meter Pigtail Cable Assembly – Includes (12) Bundled LC/APC 900 µm Pigtails in Sleeving
P6LC3	3 Meter Pigtail Cable Assembly – Includes (6) Bundled LC/UPC 900 µm Pigtails in Sleeving
P12LC3	3 Meter Pigtail Cable Assembly – Includes (12) Bundled LC/UPC 900 µm Pigtails in Sleeving

All multi-mode fiber grades are available.



# OPTICAL COMPONENTS AND ACCESSORIES

## Accessories

Catalog Number	Description
80807701	Splice Tray, COYOTE Legacy Short, Low Profile, 12 CT., Single Fusion
80806033	Splice Tray, COYOTE Legacy Short, Standard Profile, 12 CT., Single Fusion
8003468	Splice Tray, COYOTE Legacy Short, Standard Profile, 24 CT., Single Fusion
8001127	Splice Tray, COYOTE Legacy Long, Low Profile, 36 <sup>1</sup> CT., Single Fusion
80805514	Splice Tray, COYOTE Legacy Long, Standard Profile, 36 <sup>1</sup> CT., Single Fusion
80805515	Splice Tray, COYOTE Legacy Long, Deep Profile, 144 CT., Mass Fusion
800014149B	Rodent Protection Kit for RDC3 and RDC6 – Requires Grommet Port Adapter
800014150B	Rodent Protection Kit for RDC12 – Requires Grommet Port Adapter
80812784B	Rodent Protection Kit for WDC2 and WDC4 – Requires Grommet Port Adapter
80812785B	Rodent Protection Kit for WDC8 – Requires Grommet Port Adapter
8003827	1-Hole Grommet Port Adapter 0.40" – 0.60" (10.2 mm – 15.2 mm)
8003826	1-Hole Grommet Port Adapter 0.60" – 0.825" (15.2 mm – 21.0 mm)
8003825	1-Hole Grommet Port Adapter 0.825" – 1.00" (21.0 mm – 25.4 mm)
8003828	2-Hole Grommet Port Adapter 0.275" – 0.500" (7.0 mm – 12.7 mm)
8003812	4-Hole Grommet Port Adapter 0.120" – 0.275" (3.0 mm – 7.0 mm)
8003818	8-Hole Grommet Port Adapter 0.120" – 0.200" (3.0 mm – 5.1 mm)
80808618	Stepped Grommet Kit 0.070" – 1.00" (1.8 mm – 25.4 mm)

<sup>1</sup>24 CT. in pre-terminated cabinets

## ORDERING INFORMATION

### COYOTE Access Solutions Pre-Terminated Cabinets

X X X X X  
 (Section 1) (Section 2) (Section 3) (Section 4) (Section 5)

Catalog Number Example: RDC24A96SCU3

#### Section 1

Cabinet Selection (Select 1)	Description
WDC2	Wall Mount Cabinet up to 24 Fiber Connections and Splices
WDC4	Wall Mount Cabinet up to 48 Fiber Connections and Splices
WDC8	Wall Mount Cabinet up to 96 Fiber Connections and Splices
WDC12	Wall Mount Cabinet up to 144 Fiber Connections and Splices
RDC2	Rack Mount Cabinet up to 12 Fiber Connections and Splices
RDC3	Rack Mount Cabinet up to 36 Fiber Connections and Splices
RDC6	Rack Mount Cabinet up to 72 Fiber Connections and Splices
RDC12	Rack Mount Cabinet up to 144 Fiber Connections and Splices
RDC12X	Rack Mount Cabinet up to 144 Fiber Connections and Splices
RDC24	Rack Mount Cabinet up to 288 Fiber Connections and Splices
RDC36	Rack Mount Cabinet up to 432 Fiber Connections and Splices

#### Section 2

Color Options (Select 1)	
A	Almond
B	Black

#### Section 3

Adapter Port Quantity
0 to 432

#### Section 4

Connector Type (Select 1)	
SCA	SC/APC
SCU	SC/UPC
LCA	LC/APC
LCU	LC/UPC
ST	ST/UPC

#### Section 5

Pigtail Length (Select 1)	
Blank	No Pigtails
3	3 meters

**NOTE:** Pre-terminated means factory assembled with all optical ports labeled and tested for insertion loss after assembly



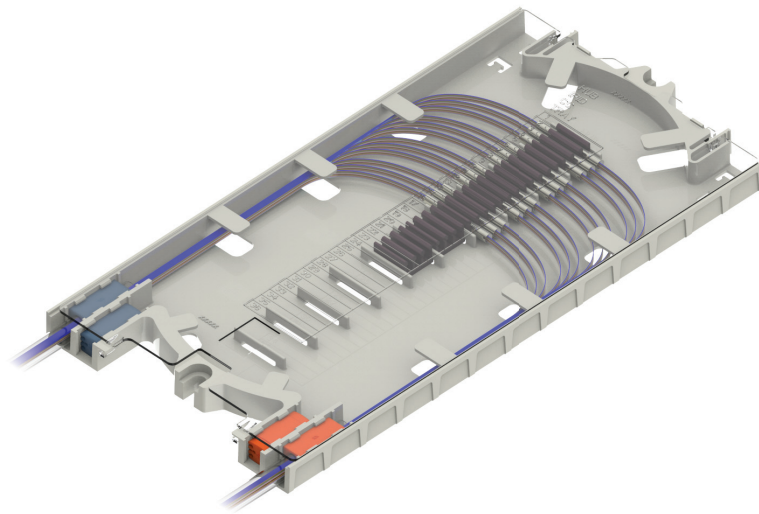

## SECTION 6 CLOSURE ACCESSORIES

COYOTE® FIBER OPTIC SOLUTIONS

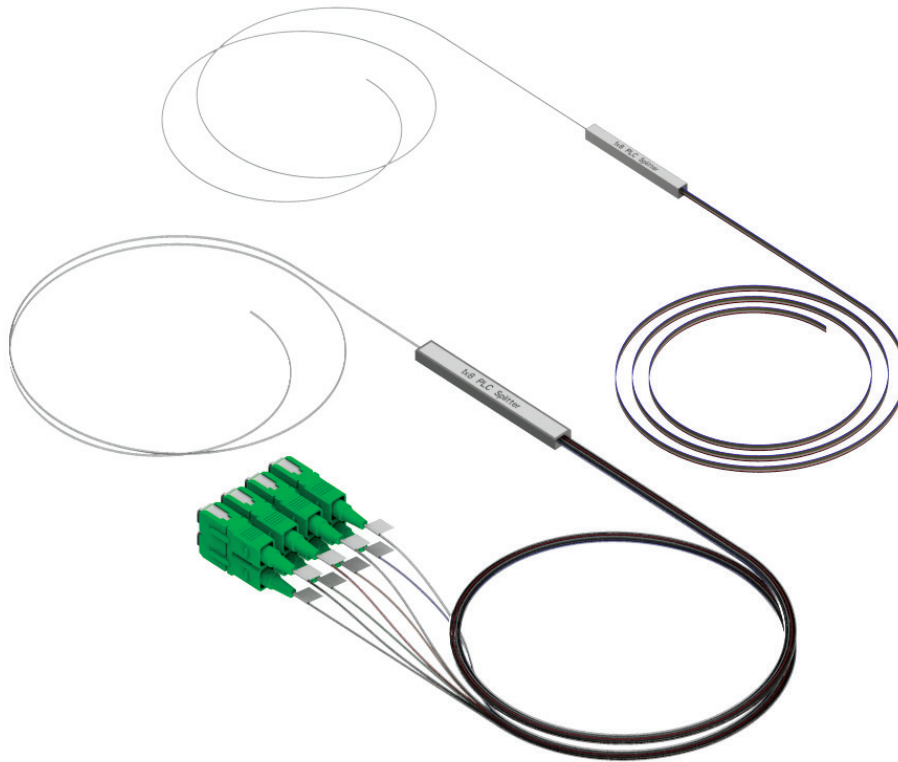

## COYOTE® PASSIVE OPTICAL COMPONENTS

**COYOTE Passive Optical Components** are the essential pieces needed to build a reliable passive optical network. With the use of components such as fiber optic splitters, connectorized pigtails, and adapters, a single fiber can provide services to multiple customers at the same time. These components also create a plug and play network that allows services to be redirected or tested without having to break and resplice fibers. COYOTE Passive Optical Components are used with COYOTE Cross-Connect Closures and COYOTE Access Solutions™ Cabinets to ensure protected splicing and connectivity.

### FEATURES AND BENEFITS

- Adapters and connectors are available in SC, LC, FC and ST styles
- Pigtail kits are available with either 2 mm jacketed or 900 µm color coded fibers
- Field installable connectors can be assembled without a special connector holder
- Bare fiber or connectorized PLC splitters provide split ratios of 1x2, 1x4, 1x8, 1x16, or 1x32

## COYOTE® ADAPTERS

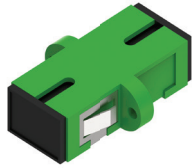

SC/APC Simplex Adapter

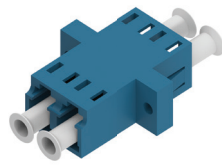

LC/UPC Duplex Adapter

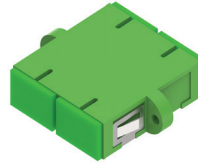

SC/APC Duplex Adapter

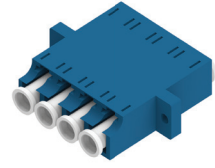

LC/UPC Quad Adapter

### COYOTE Adapter Kits

Catalog Number	Description
80813593	Adapter Kit – Includes (8) SC/APC Simplex Adapters
80813594	Adapter Kit – Includes (8) SC/UPC Simplex Adapters
80813595	Adapter Kit – Includes (8) SC/APC Duplex Adapters
80813596	Adapter Kit – Includes (8) SC/UPC Duplex Adapters
80813597	Adapter Kit – Includes (8) LC/APC Duplex Adapters
80813598	Adapter Kit – Includes (8) LC/UPC Duplex Adapters
80813599	Adapter Kit – Includes (8) LC/APC Quad Adapters
80813600	Adapter Kit – Includes (8) LC/UPC Quad Adapters

## COYOTE® ADAPTER MODULES

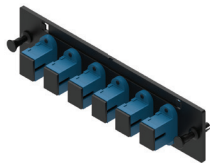
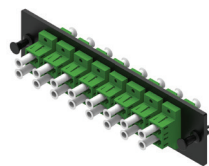
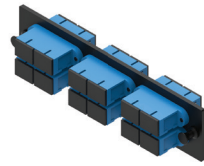
6-Port SC/UPC  
Adapter Module16-Port LC/APC  
Adapter Module12-Port SC/UPC  
Adapter Module6-Port ST  
Adapter Module

### COYOTE Adapter Module Kits

Catalog Number	Description
6SCAPC	Adapter Module Kit – Includes (1) 6-Port SC/APC Adapter Module
6SMSC	Adapter Module Kit – Includes (1) 6-Port SC/UPC Adapter Module
8SCAPC	Adapter Module Kit – Includes (1) 8-Port SC/APC Adapter Module
8SMSC	Adapter Module Kit – Includes (1) 8-Port SC/UPC Adapter Module
12SMDSCA	Adapter Module Kit – Includes (1) 12-Port SC/APC Adapter Module
12SMDSC	Adapter Module Kit – Includes (1) 12-Port SC/UPC Adapter Module
12SMLCA	Adapter Module Kit – Includes (1) 12-Port LC/APC Adapter Module
12SMLC	Adapter Module Kit – Includes (1) 12-Port LC/UPC Adapter Module
16SMLCA	Adapter Module Kit – Includes (1) 16-Port LC/APC Adapter Module
16SMLC	Adapter Module Kit – Includes (1) 16-Port LC/UPC Adapter Module
24LCAPC	Adapter Module Kit – Includes (1) 24-Port LC/APC Adapter Module
24SMLC	Adapter Module Kit – Includes (1) 24-Port LC/UPC Adapter Module
6SMST	Adapter Module Kit – Includes (1) 6-Port ST Adapter Module
8SMST	Adapter Module Kit – Includes (1) 8-Port ST Adapter Module
12SMST	Adapter Module Kit – Includes (1) 12-Port ST Adapter Module
6SMFC	Adapter Module Kit – Includes (1) 6-Port FC Adapter Module
8SMFC	Adapter Module Kit – Includes (1) 8-Port FC Adapter Module

## COYOTE® 2 MM JACKETED PIGTAIL KITS – SHORT BOOT CONNECTORS

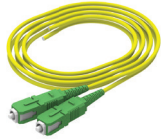

**2-Pack of 2 mm Jacketed SC/APC Pigtailed with Short Boot Connectors**

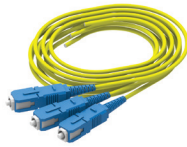

**3-Pack of 2 mm Jacketed SC/UPC Pigtailed with Short Boot Connectors**

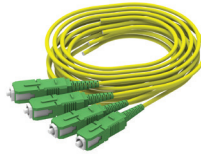

**4-Pack of 2 mm Jacketed SC/APC Pigtailed with Short Boot Connectors**



**4-Pack of 2 mm Jacketed LC/UPC Pigtailed with Short Boot Connectors**

### Short Boot Connectors

Catalog Number	Description
COYTRM-2PK-SCA-SB	Pigtail Kit – Includes (2) SC/APC 2 mm Jacketed Pigtailed with Short Boot Connectors
COYTRM-2PK-SCU-SB	Pigtail Kit – Includes (2) SC/UPC 2 mm Jacketed Pigtailed with Short Boot Connectors
COYTRM-3PK-SCA-SB	Pigtail Kit – Includes (3) SC/APC 2 mm Jacketed Pigtailed with Short Boot Connectors
COYTRM-3PK-SCU-SB	Pigtail Kit – Includes (3) SC/UPC 2 mm Jacketed Pigtailed with Short Boot Connectors
COYTRM-4PK-SCA-SB	Pigtail Kit – Includes (4) SC/APC 2 mm Jacketed Pigtailed with Short Boot Connectors
COYTRM-4PK-SCU-SB	Pigtail Kit – Includes (4) SC/UPC 2 mm Jacketed Pigtailed with Short Boot Connectors
COYTRM-4PK-LCA-SB	Pigtail Kit – Includes (4) LC/APC 2 mm Jacketed Pigtailed with Short Boot Connectors
COYTRM-4PK-LCU-SB	Pigtail Kit – Includes (4) LC/UPC 2 mm Jacketed Pigtailed with Short Boot Connectors

## COYOTE® 2 MM JACKETED PIGTAIL KITS – STANDARD BOOT CONNECTORS



**2-Pack of 2 mm Jacketed SC/UPC Pigtailed with Standard Boot Connectors**

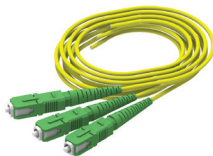

**3-Pack of 2 mm Jacketed SC/APC Pigtailed with Standard Boot Connectors**

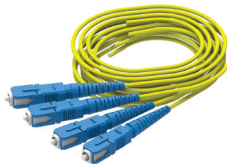

**4-Pack of 2 mm Jacketed SC/UPC Pigtailed with Standard Boot Connectors**



**4-Pack of 2 mm Jacketed LC/APC Pigtailed with Standard Boot Connectors**

### Standard Boot Connectors

Catalog Number	Description
COYTRM-2PK-SCA	Pigtail Kit – Includes (2) SC/APC 2 mm Jacketed Pigtailed with Standard Boot Connectors
COYTRM-2PK-SCU	Pigtail Kit – Includes (2) SC/UPC 2 mm Jacketed Pigtailed with Standard Boot Connectors
COYTRM-3PK-SCA	Pigtail Kit – Includes (3) SC/APC 2 mm Jacketed Pigtailed with Standard Boot Connectors
COYTRM-3PK-SCU	Pigtail Kit – Includes (3) SC/UPC 2 mm Jacketed Pigtailed with Standard Boot Connectors
COYTRM-4PK-SCA	Pigtail Kit – Includes (4) SC/APC 2 mm Jacketed Pigtailed with Standard Boot Connectors
COYTRM-4PK-SCU	Pigtail Kit – Includes (4) SC/UPC 2 mm Jacketed Pigtailed with Standard Boot Connectors
COYTRM-4PK-LCA	Pigtail Kit – Includes (4) LC/APC 2 mm Jacketed Pigtailed with Standard Boot Connectors
COYTRM-4PK-LCU	Pigtail Kit – Includes (4) LC/UPC 2 mm Jacketed Pigtailed with Standard Boot Connectors

## COYOTE® FIBER PIGTAIL CABLE ASSEMBLIES

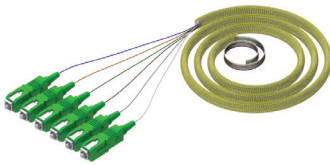

**6-Fiber SC/APC Pigtail Cable Assembly**

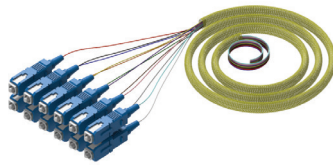

**12-Fiber SC/UPC Pigtail Cable Assembly**

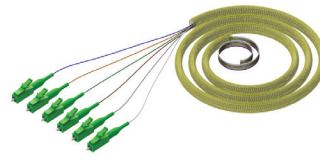

**6-Fiber LC/APC Pigtail Cable Assembly**

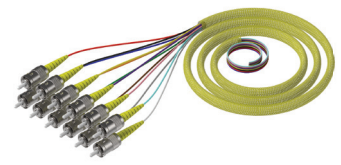

**12-Fiber ST Pigtail Cable Assembly**

### Assembly Kits

Catalog Number	Description
P6SCA3	3 m Pigtail Cable Assembly Kit – Includes (6) Bundled SC/APC 900 µm Pigtails in Sleeving
P6SCU3	3 m Pigtail Cable Assembly Kit – Includes (6) Bundled SC/UPC 900 µm Pigtails in Sleeving
P12SCA3	3 m Pigtail Cable Assembly Kit – Includes (12) Bundled SC/APC 900 µm Pigtails in Sleeving
P12SCU3	3 m Pigtail Cable Assembly Kit – Includes (12) Bundled SC/UPC 900 µm Pigtails in Sleeving
P6LCA3	3 m Pigtail Cable Assembly Kit – Includes (6) Bundled LC/APC 900 µm Pigtails in Sleeving
P6LC3	3 m Pigtail Cable Assembly Kit – Includes (6) Bundled LC/UPC 900 µm Pigtails in Sleeving
P12LCA3	3 m Pigtail Cable Assembly Kit – Includes (12) Bundled LC/APC 900 µm Pigtails in Sleeving
P12LC3	3 m Pigtail Cable Assembly Kit – Includes (12) Bundled LC/UPC 900 µm Pigtails in Sleeving
P6ST3	3 m Pigtail Cable Assembly Kit – Includes (6) Bundled ST 900 µm Pigtails in Sleeving
P12ST3	3 m Pigtail Cable Assembly Kit – Includes (12) Bundled ST 900 µm Pigtails in Sleeving
P6FC3	3 m Pigtail Cable Assembly Kit – Includes (6) Bundled FC 900 µm Pigtails in Sleeving
P12FC3	3 m Pigtail Cable Assembly Kit – Includes (12) Bundled FC 900 µm Pigtails in Sleeving

## COYOTE® 900 µm FIBER PIGTAIL KITS

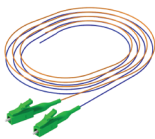

**2-Pack of 1.5 Meter SC/APC 900 µm Color Coded Pigtails**

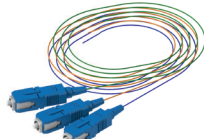

**3-Pack of 1.5 Meter SC/UPC 900 µm Color Coded Pigtails**

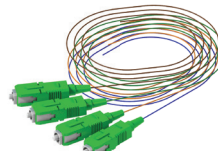

**4-Pack of 1.5 Meter SC/APC 900 µm Color Coded Pigtails**

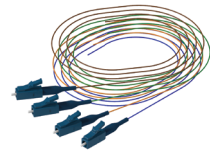

**4-Pack of 1.5 Meter LC/UPC 900 µm Color Coded Pigtails**

### Fiber Pigtail Kits

Catalog Number	Description
800013979	Fiber Pigtail Kit – Includes (2) 1.5 m SC/APC 900 µm Color Coded Pigtails
800014109	Fiber Pigtail Kit – Includes (2) 1.5 m SC/UPC 900 µm Color Coded Pigtails
800013980	Fiber Pigtail Kit – Includes (3) 1.5 m SC/APC 900 µm Color Coded Pigtails
800014110	Fiber Pigtail Kit – Includes (3) 1.5 m SC/UPC 900 µm Color Coded Pigtails
800015055	Fiber Pigtail Kit – Includes (4) 1.5 m SC/APC 900 µm Color Coded Pigtails
80812558	Fiber Pigtail Kit – Includes (4) 1.5 m SC/UPC 900 µm Color Coded Pigtails
80812983	Fiber Pigtail Kit – Includes (2) 1.5 m LC/APC 900 µm Color Coded Pigtails
80812985	Fiber Pigtail Kit – Includes (2) 1.5 m LC/UPC 900 µm Color Coded Pigtails
80812559	Fiber Pigtail Kit – Includes (4) 1.5 m LC/APC 900 µm Color Coded Pigtails
80812560	Fiber Pigtail Kit – Includes (4) 1.5 m LC/UPC 900 µm Color Coded Pigtails

## COYOTE® FIELD INSTALLABLE CONNECTORS

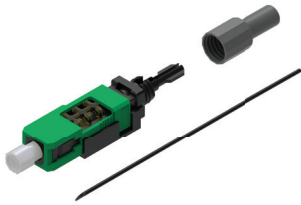

**SC/APC Field Installable Connectors**

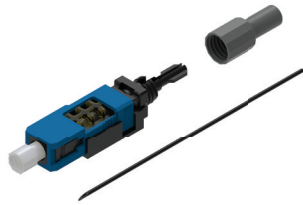

**SC/UPC Field Installable Connectors**



**LC/APC Field Installable Connectors**

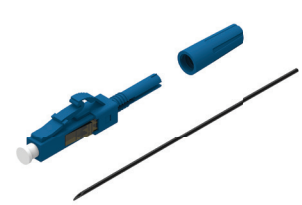

**LC/UPC Field Installable Connectors**

### Specifications

Item	Performance
Standard	TIA / EIA 604-3 (SC) and TIA / EIA 604-10 (LC)
Insertion Loss	Typ. 0.3dB / Max. 0.5dB
Return Loss	Typ. 50dB / Max. 55dB (PC) Typ. 55dB / Max. 60dB (APC)
Endurance	≤ 0.3dB, 500 times reconnection
Tension	≤ 0.2dB change, 3.0kg
Temperature Change	≤ 0.3dB change, 21 times / -40°C to +75°C

### COYOTE Field Installable Connector Kits for 250 μm and 900 μm Cable Types

Catalog Number	Description
80813501	Field Installable Connector Kit – Includes (6) SC/APC Field Installable Connectors
80813502	Field Installable Connector Kit – Includes (12) SC/APC Field Installable Connectors
80813503	Field Installable Connector Kit – Includes (6) SC/UPC Field Installable Connectors
80813504	Field Installable Connector Kit – Includes (12) SC/UPC Field Installable Connectors
80813505	Field Installable Connector Kit – Includes (6) LC/APC Field Installable Connectors
80813506	Field Installable Connector Kit – Includes (12) LC/APC Field Installable Connectors
80813507	Field Installable Connector Kit – Includes (6) LC/UPC Field Installable Connectors
80813508	Field Installable Connector Kit – Includes (12) LC/UPC Field Installable Connectors

# COYOTE® PLC SPLITTERS

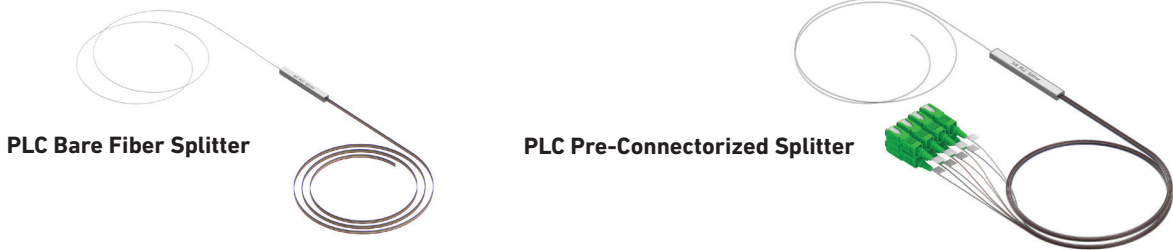

## COYOTE Bare Fiber Splitters

Catalog Number	Description
COYSP1X2	COYOTE Bare Fiber Splitter – 1x2
COYSP1X4	COYOTE Bare Fiber Splitter – 1x4
COYSP1X8	COYOTE Bare Fiber Splitter – 1x8
COYSP1X16	COYOTE Bare Fiber Splitter – 1x16
COYSP1X32	COYOTE Bare Fiber Splitter – 1x32

Add Suffix: -S for 250um Output Legs

## COYOTE Pre-Connectorized Splitters

Catalog Number	Description
COYSP1X2SCA	COYOTE Pre-Connectorized Splitter – 1x2 SC/APC
COYSP1X4SCA	COYOTE Pre-Connectorized Splitter – 1x4 SC/APC
COYSP1X8SCA	COYOTE Pre-Connectorized Splitter – 1x8 SC/APC
COYSP1X16SCA	COYOTE Pre-Connectorized Splitter – 1x16 SC/APC
COYSP1X32SCA	COYOTE Pre-Connectorized Splitter – 1x32 SC/APC

## Specifications: Bare Fiber and Pre-Connectorized Splitters

	Units	1x2	1x4	1x8	1x16	1x32
Operating Wavelength	nm	1260 – 1650	1260 – 1650	1260 – 1650	1260 – 1650	1260 – 1650
Insertion Loss (Maximum)	dB	3.6 <sup>1</sup>	7.2 <sup>1</sup>	10.5 <sup>1</sup>	13.5 <sup>1</sup>	16.5 <sup>1</sup>
		Max. 4.0 <sup>2</sup> Typ. 3.6 <sup>2</sup>	Max. 8.0 <sup>2</sup> Typ. 7.7 <sup>2</sup>	Max. 11.5 <sup>2</sup> Typ. 11.0 <sup>2</sup>	Max. 14.5 <sup>2</sup> Typ. 14.2 <sup>2</sup>	Max. 17.5 <sup>2</sup> Typ. 17.2 <sup>2</sup>
Uniformity (Maximum)	dB	0.4 <sup>1</sup>	0.6 <sup>1</sup>	0.8 <sup>1</sup>	1.2 <sup>1</sup>	1.7 <sup>1</sup>
PDL (Maximum)	dB	0.2 <sup>1</sup>	0.2 <sup>1</sup>	0.3 <sup>1</sup>	0.3 <sup>1</sup>	0.3 <sup>1</sup>
Return Loss (Minimum)	dB	55.0 <sup>1</sup>	55.0 <sup>1</sup>	55.0 <sup>1</sup>	55.0 <sup>1</sup>	55.0 <sup>1</sup>
Directivity (Minimum)	dB	55.0	55.0	55.0	55.0	55.0
Operating Temperature	°C	-40 to +85	-40 to +85	-40 to +85	-40 to +85	-40 to +85
Input/Output Legs	m	1 (Standard) or Custom Length Available (Input/250 µm, Output/Ribbon fiber)				
Dimensions – Bare Fiber	mm	40 L x 4 W x 4 H	40 L x 4 W x 4 H	40 L x 4 W x 4 H	40 L x 4 W x 4 H	50 L x 7 W x 4 H
Dimensions – Connectorized	mm	60 L x 7 W x 4 H	60 L x 7 W x 4 H	60 L x 7 W x 4 H	60 L x 12 W x 5 H	80 L x 20 W x 6 H

<sup>1</sup>Excluding WDL (Wavelength Dependant Loss) and TDL (Temperature Dependant Loss). Measured at room temp.1310 nm and 1550 nm.

<sup>2</sup>Including WDL and TDL. 1 x 2 FBT Splitters and 1 x 64 PLC Splitter Modules are available upon request.

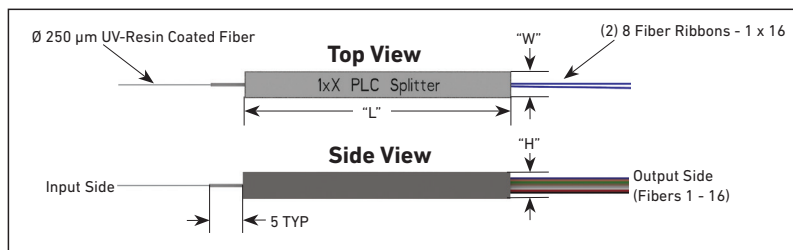

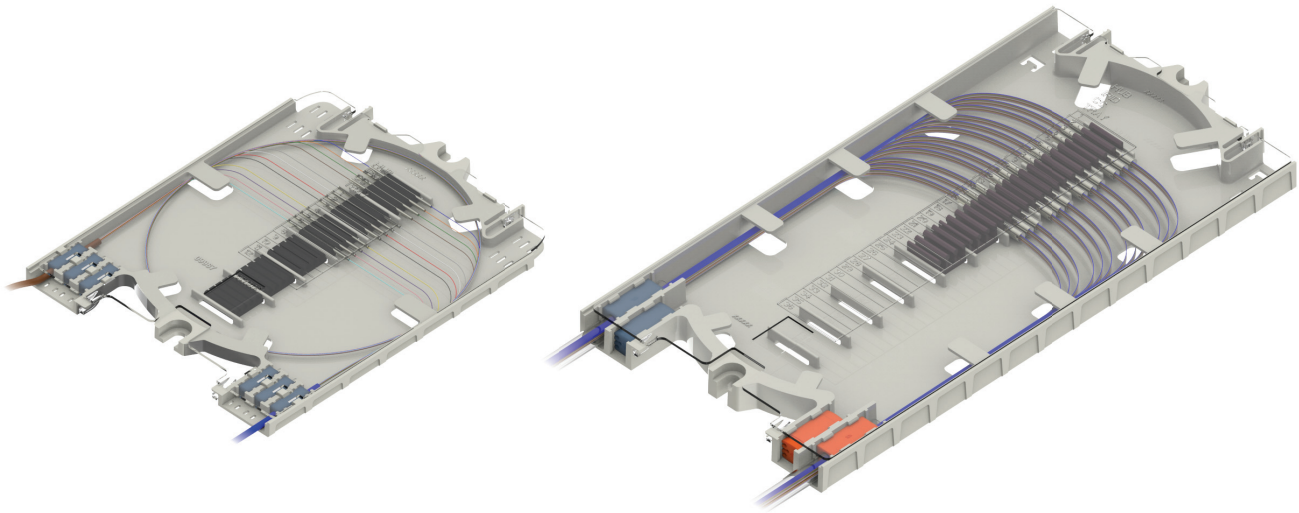

## COYOTE® SPLICE TRAYS

**COYOTE Splice Trays** are necessary components within most COYOTE fiber optic closures to manage, store, and protect fibers and splices. COYOTE splice trays are injection molded and have hinged, clear plastic covers to protect and allow for visible inspection of the fibers. They are available in Legacy and LITE-GRIP® styles, each providing unique features and benefits to best fit the fiber management and splice capacity requirements of the closure. Both splice tray styles come in short and long versions for either single fusion or mass fusion/ribbon splicing. Short splice trays are used in the COYOTE In-Line RUNT, ONE, Terminal Closures, 6.5" x 17" Dome Closure, 9.5" x 19" Dome Closure, and COYOTE GLC 17". Long splice trays are used in the COYOTE 6.5" x 22" Dome Closure, 9.5" x 28" Dome Closure, and COYOTE GLC 28".

### FEATURES AND BENEFITS

#### Legacy Splice Tray

- Routing channels allow fibers to enter the splice tray at the same entrance point, allowing buffer tubes and transportation tubes to coil easy within the closure
- Buffer tubes or transportation tubes are secured to the splice trays with felt and tie wraps
- Available in low profile, standard, and deep profile heights to achieve the desired splice count within the closure

#### LITE-GRIP Splice Tray

- Routing channels of the splice tray accept LITE-GRIP Retention Sleeves that are designed to grip buffer tubes, pigtails, or transportation tubing without the possibility of attenuation during installation and eliminates the need for tie wraps, reducing installation time
- Removable splice blocks provide the flexibility to interchange splice blocks to store single fusion splices, mass fusion/ribbon splices, mechanical splices, or PLC splitters on the same splice tray
- Available in low profile, standard, and deep profile heights to achieve the desired splice count within the closure

## COYOTE® LEGACY SHORT SPLICE TRAY KITS

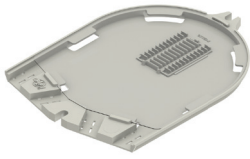

COYOTE Legacy Short Low Profile Splice Tray Kit for Single Fusion Splices (12 Splice CT.)  
**Catalog Number: 80807701**

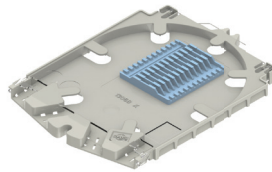

COYOTE Legacy Short Standard Profile Splice Tray Kit for Single Fusion Splices (12 Splice CT.)  
**Catalog Number: 80806033**

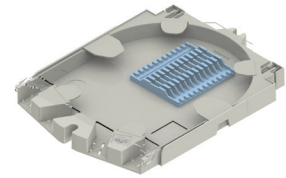

COYOTE Legacy Short Deep Profile Splice Tray Kit for Ribbon/Mass Fusion Splices (72 Splice CT.)  
**Catalog Number: 80807114**

## COYOTE® LITE-GRIP® SHORT SPLICE TRAY KITS

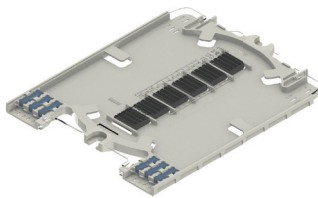

COYOTE LITE-GRIP Short Low Profile Splice Tray Kit for Single Fusion Splices (24 Splice CT.)  
**Catalog Number: 80809958**

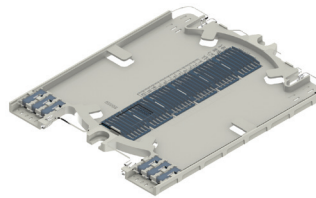

COYOTE LITE-GRIP Short Low Profile Splice Tray Kit for Single Fusion Splices (36 Splice CT.)  
**Catalog Number: 80813152**

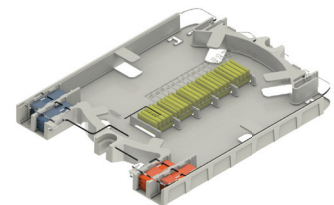

COYOTE LITE-GRIP Short Deep Profile Splice Tray Kit for Double Stacked Single Fusion Splices (40 Splice CT.)  
**Catalog Number: 80808945**

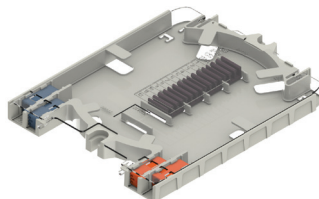

COYOTE LITE-GRIP Short Deep Profile Splice Tray Kit for Ribbon/Mass Fusion Splices (144 Splice CT.)  
**Catalog Number: LGSTR144**

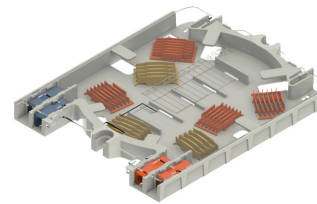

COYOTE LITE-GRIP Short Deep Profile Splice Tray Kit for (48 CT. Single Fusion) (144 CT. Mass Fusion)  
**Catalog Number: 80814649**

## COYOTE® LITE-GRIP® SHORT SPLITTER TRAY KITS

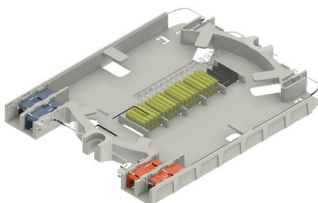

COYOTE LITE-GRIP Short Deep Profile Splice Tray Kit for Single Fusion Splices, Bare Fiber Splitters, & 1x4 Pre-Connectorized Splitters (32 Splice CT.)  
**Catalog Number: LGSTS-SPLIT**

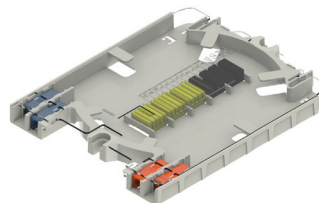

COYOTE LITE-GRIP Short Deep Profile Splice Tray Kit for Single Fusion Splices, 1x8 Pre-Connectorized Splitters, & 1x16 Pre-Connectorized Splitters (32 Splice CT.)  
**Catalog Number: LGSTS1x816PC**

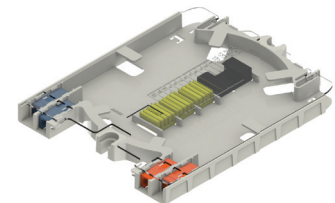

COYOTE LITE-GRIP Short Deep Profile Splice Tray Kit for Single Fusion Splices & 1x32 Pre-Connectorized Splitters (24 Splice CT.)  
**Catalog Number: LGSTS1x32PC**



## COYOTE® LEGACY LONG SPLICE TRAY KITS

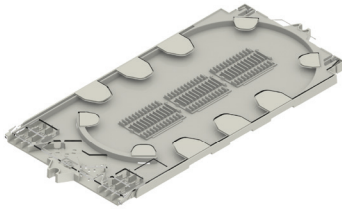

COYOTE Legacy Long Low Profile Splice Tray Kit for Single Fusion Splices (36 Splice CT.)  
**Catalog Number: 8001127**

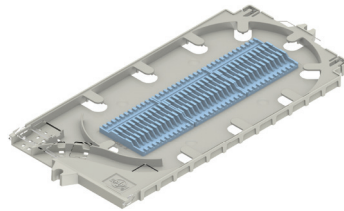

COYOTE Legacy Long Standard Profile Splice Tray Kit for Single Fusion Splices (36 Splice CT.)  
**Catalog Number: 80805514**

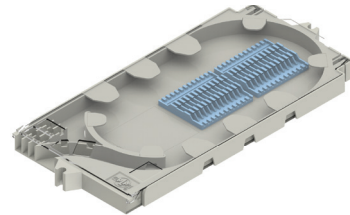

COYOTE Legacy Long Deep Profile Splice Tray Kit for Ribbon/Mass Fusion Splices (144 Splice CT.)  
**Catalog Number: 80805515**

## COYOTE® LITE-GRIP® LONG SPLICE TRAY KITS

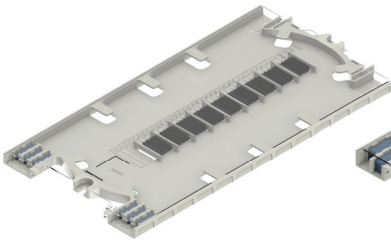

COYOTE LITE-GRIP Long Standard Profile Splice Tray Kit for Single Fusion Splices (36 Splice CT.)  
**Catalog Number: 80810086**

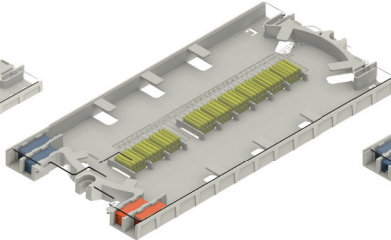

COYOTE LITE-GRIP Long Deep Profile Splice Tray Kit for Double Stacked Single Fusion Splices (72 Splice CT.)  
**Catalog Number: LGSTS72**

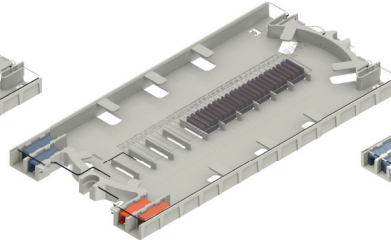

COYOTE LITE-GRIP Long Deep Profile Splice Tray Kit for Ribbon/Mass Fusion Splices (216 Splice CT.)  
**Catalog Number: LGSTR216**

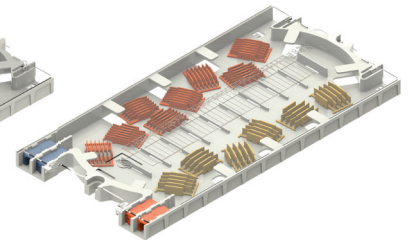

COYOTE LITE-GRIP Long Deep Profile Splice Tray Kit for Ribbon/Mass Fusion Splices (96 CT. Single Fusion) (288 CT. Mass Fusion)  
**Catalog Number: 80814650**

## COYOTE® LITE-GRIP® LONG SPLITTER TRAY KITS

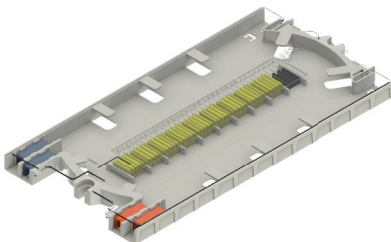

COYOTE LITE-GRIP Long Deep Profile Splice Tray Kit for Single Fusion Splices, Bare Fiber Splitters, & 1x4 Pre-Connectorized Splitters (72 Splice CT.)  
**Catalog Number: LGSTL-SPLIT**

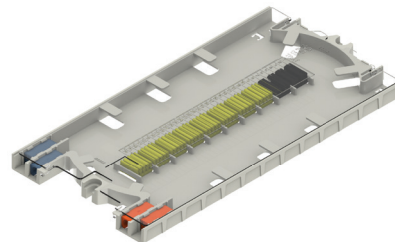

COYOTE LITE-GRIP Long Deep Profile Splice Tray Kit for Single Fusion Splices, 1x8 Pre-Connectorized Splitters, & 1x16 Pre-Connectorized Splitters (64 Splice CT.)  
**Catalog Number: 800013831**

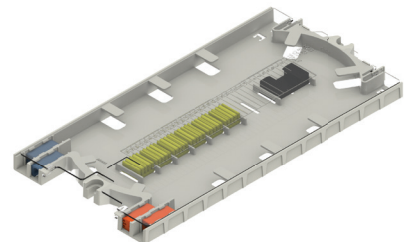

COYOTE LITE-GRIP Long Deep Profile Splice Tray Kit for Single Fusion Splices & 1x32 Pre-Connectorized Splitters (48 Splice CT.)  
**Catalog Number: LGSTL1x32PC**

## ACCESSORIES



**LITE-GRIP® 4 CT. Low Profile Splice Block for Single Fusion Splices (Black)**

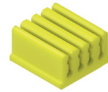

**LITE-GRIP 8 CT. Splice Block for Single Fusion Splices (Yellow)**



**LITE-GRIP 36 CT. Splice Block for Ribbon/Mass Fusion Splices (Purple)**

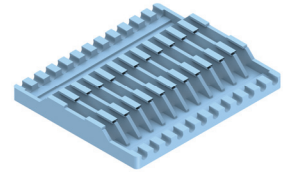

**Elastomeric 12 CT. Splice Block for Single or Ribbon/Mass Fusion Splices (Light Blue)**

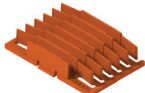

**Plastic 12 CT. Splice Block for Single Fusion Splices (Orange)**

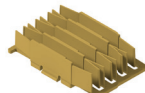

**Plastic 48 CT. Splice Block for Ribbon/Mass Fusion Splices (Mustard)**

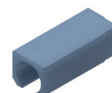

**LITE-GRIP 1-Hole Retention Sleeve (Blue)**



**LITE-GRIP 1-Hole Retention Sleeve (Orange)**

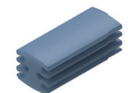

**LITE-GRIP 6-Hole Retention Sleeve (Blue)**



**LITE-GRIP 6-Hole Retention Sleeve (Orange)**

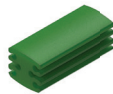

**LITE-GRIP 6-Hole Retention Sleeve (Green)**



**40 mm Heat Shrink Splice Protector - Single Fusion**



**60 mm Heat Shrink Splice Protector - Single Fusion**







**40 mm Heat Shrink Splice Protector - Mass Fusion**

### COYOTE Splice Tray Accessory Kits



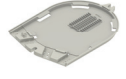

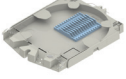
Catalog Number	Description
LGSBS4-5	Splice Block Kit – Includes (5) LITE-GRIP® Low Profile 4 CT. Single Fusion Splice Blocks, Black
LGSBS8-5	Splice Block Kit – Includes (5) LITE-GRIP 8 CT. Single Fusion Splice Blocks, Yellow
LGSBS8-50	Splice Block Kit – Includes (50) LITE-GRIP 8 CT. Single Fusion Splice Blocks, Yellow
LGSBR3-5	Splice Block Kit – Includes (5) LITE-GRIP 36 CT. Mass Fusion Splice Blocks, Purple
LGSBR3-50	Splice Block Kit – Includes (50) LITE-GRIP 36 CT. Mass Fusion Splice Blocks, Purple
8003381	Splice Block Kit – Includes (3) 12 CT. Elastomeric Single Fusion Splice Blocks, Light Blue
80813362	Splice Block Kit – Includes (6) 12 CT. Plastic Single Fusion Splice Blocks, Orange
8004153	Splice Block Kit – Includes (6) 48 CT. Plastic Single Fusion Splice Blocks, Mustard
LGRS1-25B	Retention Sleeve Kit – Includes (25) LITE-GRIP 1-Hole Retention Sleeve, Blue
LGRS1-25OR	Retention Sleeve Kit – Includes (25) LITE-GRIP 1-Hole Retention Sleeve, Orange
LGRS6-25B	Retention Sleeve Kit – Includes (25) LITE-GRIP 6-Hole Retention Sleeve, Blue
LGRS6-25OR	Retention Sleeve Kit – Includes (25) LITE-GRIP 6-Hole Retention Sleeve, Orange
LGRS6-25G	Retention Sleeve Kit – Includes (25) LITE-GRIP 6-Hole Retention Sleeve, Green
LGRSF2-25	Retention Sleeve Kit - Includes (25) 2-Slot Foam Microtube Retention Sleeve, Black
80808187	Heat Shrink Splice Protector Kit – Includes (12) 40 mm Single Fusion
8004095	Heat Shrink Splice Protector Kit – Includes (50) 40 mm Single Fusion
8003509	Heat Shrink Splice Protector Kit – Includes (12) 60 mm Single Fusion
8003717	Heat Shrink Splice Protector Kit – Includes (50) 60 mm Single Fusion
8003993	Heat Shrink Splice Protector Kit – Includes (12) 40 mm Mass Fusion
8004160	Heat Shrink Splice Protector Kit – Includes (50) 40 mm Mass Fusion
8003490	Felt Tape Kit – Includes (6) Buffer Tube Felt Strips
80808613	Express Fiber Storage Ring – For Deep Profile LITE-GRIP Splice Trays ONLY

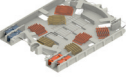

## COYOTE® SHORT SPLICE TRAY CAPACITIES FOR COYOTE® CLOSURES

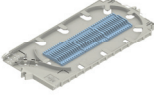
COYOTE Short Splice Trays	COYOTE Closures													
	Organizer Type	In-Line RUNT	ONE		6.5" x 17" Dome		9.5" x 19" Dome		Terminal Closure		9.5" x 17" GLC			
			Buffer Tube	Universal	Buffer Tube	Unitube/Ribbon	Buffer Tube	Unitube/Ribbon	Single Chamber	Dual Chamber	Universal	Max. Tray	Cross-Connect	OptiTap®
<b>Single Fusion Splice Trays (Listed from Lowest to Highest Splice CT.)</b>														
 Cat. No. 80806033 (12 Splice CT.)	2 Trays (24 CT.)	3 Trays (36 CT.)	3 Trays (36 CT.)	4 Trays (48 CT.)	4 Trays (48 CT.)	9 Trays (108 CT.)	8 Trays (96 CT.)	2 Trays (24 CT.)	4 Trays (48 CT.)	3 Trays (36 CT.)	8 Trays (96 CT.)	3 Trays (36 CT.)	3 Trays (36 CT.)	
 Cat. No. 80807701 (12 Splice CT.)	4 Trays (48 CT.)	4 Trays (48 CT.)	3 Trays (36 CT.)	6 Trays (72 CT.)	6 Trays (72 CT.)	12 Trays (144 CT.)	12 Trays (144 CT.)	4 Trays (48 CT.)	8 Trays (96 CT.)	4 Trays (48 CT.)	13 Trays (156 CT.)	4 Trays (48 CT.)	4 Trays (48 CT.)	
 Cat. No. 80808945 (40 Splice CT.)	2 Trays (80 CT.)	2 Trays (80 CT.)	2 Trays (80 CT.)	3 Trays (120 CT.)	3 Trays (120 CT.)	6 Trays (240 CT.)	6 Trays (240 CT.)	2 Trays (80 CT.)	4 Trays (160 CT.)	2 Trays (80 CT.)	6 Trays (240 CT.)	2 Trays (80 CT.)	2 Trays (80 CT.)	
 Cat. No. 80809958 (24 Splice CT.)	4 Trays (96 CT.)	4 Trays (96 CT.)	3 Trays (72 CT.)	6 Trays (144 CT.)	6 Trays (144 CT.)	12 Trays (288 CT.)	12 Trays (288 CT.)	4 Trays (96 CT.)	8 Trays (192 CT.)	4 Trays (96 CT.)	13 Trays (312 CT.)	4 Trays (96 CT.)	4 Trays (96 CT.)	
 Cat. No. 80813152 (36 Splice CT.)	4 Trays (144 CT.)	4 Trays (144 CT.)	3 Trays (108 CT.)	6 Trays (216 CT.)	6 Trays (216 CT.)	12 Trays (432 CT.)	12 Trays (432 CT.)	4 Trays (144 CT.)	8 Trays (288 CT.)	4 Trays (144 CT.)	13 Trays (468 CT.)	4 Trays (144 CT.)	4 Trays (144 CT.)	
<b>Ribbon/Mass Fusion Splice Trays (Listed from Lowest to Highest Splice CT.)</b>														
 Cat. No. 80807114 (72 Splice CT.)	2 Trays (144 CT.)	N/A	2 Trays (144 CT.)	N/A	3 Trays (216 CT.)	N/A	6 Trays (432 CT.)	2 Trays (144 CT.)	4 Trays (288 CT.)	2 Trays (144 CT.)	N/A	2 Trays (144 CT.)	2 Trays (144 CT.)	
 Cat. No. LGSTR144 (144 Splice CT.)	2 Trays (288 CT.)	N/A	2 Trays (288 CT.)	N/A	3 Trays (432 CT.)	N/A	6 Trays (864 CT.)	2 Trays (288 CT.)	4 Trays (576 CT.)	2 Trays (288 CT.)	N/A	2 Trays (288 CT.)	2 Trays (288 CT.)	
<b>Single Fusion and/or Mass Fusion/Ribbon Splice Tray</b>														
 Cat. No. 80814649 (48 CT. Single Fusion) (144 CT. Mass Fusion)	2 Trays (288 CT.)	N/A	2 Trays (288 CT.)	N/A	3 Trays (432 CT.)	N/A	6 Trays (864 CT.)	2 Trays (288 CT.)	4 Trays (576 CT.)	2 Trays (288 CT.)	N/A	2 Trays (288 CT.)	2 Trays (288 CT.)	

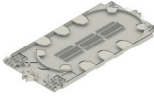
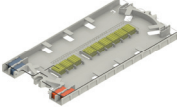
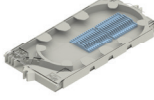
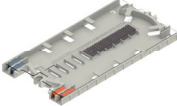
# COYOTE® LONG SPLICE TRAY CAPACITIES FOR COYOTE® CLOSURES

COYOTE Long Splice Trays	COYOTE Closures							
	6.5" x 22" Dome		9.5" x 28" Dome			9.5" x 28" GLC		
	Buffer Tube	Unitube/ Ribbon	Buffer Tube	Unitube/ Ribbon	Max. Tray	Universal	Max. Tray	Cross-Connect
<b>Single Fusion Splice Trays (Listed from Lowest to Highest Splice CT.)</b>								
 Cat. No. 80805514 (36 Splice CT.)	4 Trays (144 CT.)	4 Trays (144 CT.)	10 Trays (360 CT.)	11 Trays (396 CT.)	15 Trays (540 CT.)	5 Trays (180 CT.)	9 Trays (324 CT.)	5 Trays (180 CT.)
 Cat. No. 80810086 (36 Splice CT.)	4 Trays (144 CT.)	4 Trays (144 CT.)	10 Trays (360 CT.)	11 Trays (396 CT.)	15 Trays (540 CT.)	5 Trays (180 CT.)	9 Trays (324 CT.)	5 Trays (180 CT.)
 Cat. No. 8001127 (36 Splice CT.)	6 Trays (216 CT.)	6 Trays (216 CT.)	12 Trays (432 CT.)	16 Trays (576 CT.)	20 Trays (720 CT.)	8 Trays (288 CT.)	12 Trays (432 CT.)	8 Trays (288 CT.)
 Cat. No. LGSTS72 (72 Splice CT.)	3 Trays (216 CT.)	3 Trays (216 CT.)	6 Trays (432 CT.)	8 Trays (576 CT.)	10 Trays (720 CT.)	4 Trays (288 CT.)	6 Trays (432 CT.)	4 Trays (288 CT.)
<b>Ribbon/Mass Fusion Splice Trays (Listed from Lowest to Highest Splice CT.)</b>								
 Cat. No. 80805515 (144 Splice CT.)	N/A	3 Trays (432 CT.)	N/A	8 Trays (1152 CT.)	10 Trays (1440 CT.)	4 Trays (576 CT.)	N/A	N/A
 Cat. No. LGSTR216 (216 Splice CT.)	N/A	3 Trays (648 CT.)	N/A	8 Trays (1728 CT.)	10 Trays (2160 CT.)	4 Trays (864 CT.)	N/A	N/A
<b>Single Fusion and/or Mass Fusion/Ribbon Splice Tray</b>								
 Cat. No. 80814650 (96 CT. Single Fusion) (288 CT. Mass Fusion)	N/A	3 Trays (864 CT.)	N/A	8 Trays (2304 CT.)	10 Trays (2880 CT.)	4 Trays (1152 CT.)	N/A	N/A

## SLEEVING AND TUBING KITS FOR CABLE MANAGEMENT

The COYOTE closures are designed to manage a variety of fiber optic cable types.

Buffered ribbon cables are stored and routed in the side storage brackets or buffer tube brackets of the organizer. Cables with pliable subunits can take advantage of the large bend radius created by these side storage brackets and store expressed subunits without having to be concerned about tube fatigue. In addition, this style of tube can be routed directly to the splice trays. Rigid tubes need to be broken out and transitioned to the splice trays. This can be accomplished with either expandable braided sleeving or split braided wrap.

### Expandable Braided Sleeving

Ideal for cut cable applications

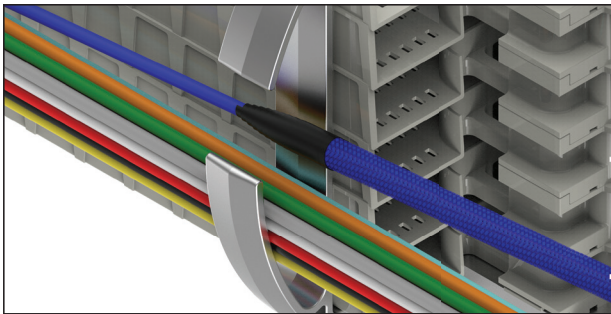

### Split Braided Wrap

Ideal for expressed cable applications

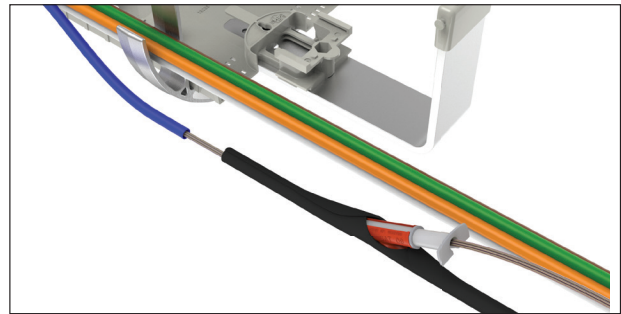

If needed, the Wire Loom Insertion Tool (**Catalog Number: 80813518**) can be used to install the split braided wrap onto the bare fibers/ribbons.

## COYOTE® SPLIT BRAIDED WRAP

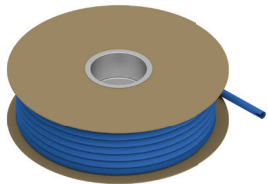

100' Spool of Split Braided Wrap – Blue  
Catalog Number: 8004174

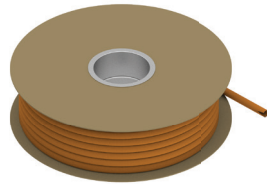

100' Spool of Split Braided Wrap – Orange  
Catalog Number: 8004175

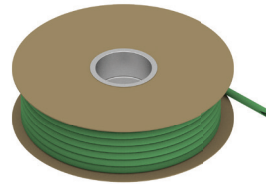

100' Spool of Split Braided Wrap – Green  
Catalog Number: 8004176

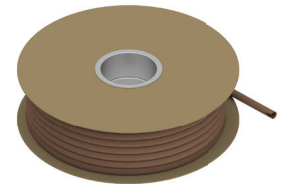

100' Spool of Split Braided Wrap – Brown  
Catalog Number: 8004177

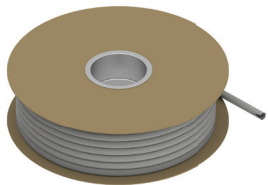

100' Spool of Split Braided Wrap – Slate  
Catalog Number: 8004178

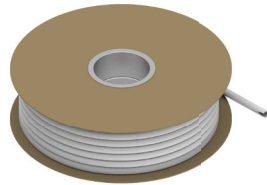

100' Spool of Split Braided Wrap – White  
Catalog Number: 8004167

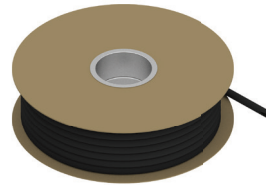

100' Spool of Split Braided Wrap – Black  
Catalog Number: 8004168



Wire Loom Insertion Tool  
Catalog Number: 80813518

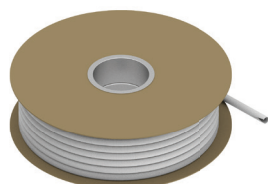

200' Spool of Split Wrap, 1/4" Diameter, White  
Catalog Number: 8004231

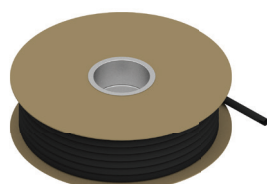

200' Spool of Split Wrap, 1/4" Diameter, Black  
Catalog Number: 8004232

## COYOTE® TUBING AND SLEEVING KITS



Transport Tubing – 0.25" ID



Spiral Tubing – 0.50" ID

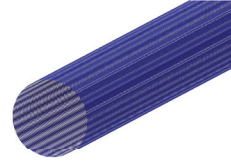

Braided Expandable Sleeving –  
3/8" Diameter



Split Braided Wrap –  
3/8" Diameter

6

CLOSURE ACCESSORIES

### COYOTE Tubing and Sleeving Kits

Catalog Number	Description
80805293	Tubing Kit – Includes (6) 0.135" ID x 35" Long Tubes
8003176	Tubing Kit – Includes (8) 0.135" ID x 35" Long Tubes
80806439	Tubing Kit – Includes (6) 0.170" ID x 35" Long Tubes
80812618	Tubing Kit – Includes (4) 0.25" ID x 25" Long Tubes
80813227	Tubing Kit – Includes (6) 0.25" ID x 36" Long Tubes
8003280	Tubing Kit – Includes (1) 0.135" ID x 25" Long Tube, (1) 0.170" ID x 25" Long Tube and (1) 0.25" ID x 25" Long Tube
80807989	100' Roll of 0.17" ID Tubing
80807991	100' Roll of 0.25" ID Tubing
80812881	100' Roll of 0.50" ID Spiral Wrap Tubing
8004154	125' Spool of Braided Expandable Sleeving, 3/8" Diameter, Blue
8004155	125' Spool of Braided Expandable Sleeving, 3/8" Diameter, Orange
8004156	125' Spool of Braided Expandable Sleeving, 3/8" Diameter, Green
8004157	125' Spool of Braided Expandable Sleeving, 3/8" Diameter, Brown
8004158	125' Spool of Braided Expandable Sleeving, 3/8" Diameter, Slate
8004159	125' Spool of Braided Expandable Sleeving, 3/8" Diameter, White
8004206	125' Spool of Braided Expandable Sleeving, 3/8" Diameter, Red
8004207	125' Spool of Braided Expandable Sleeving, 3/8" Diameter, Black
8004044	125' Spool of Braided Expandable Sleeving, 3/8" Diameter, Yellow
8004208	125' Spool of Braided Expandable Sleeving, 3/8" Diameter, Violet
8004209	125' Spool of Braided Expandable Sleeving, 3/8" Diameter, Rose
8004210	125' Spool of Braided Expandable Sleeving, 3/8" Diameter, Aqua
80813680	Braided Expandable Sleeving Kit – Includes (6) 125' Spools of Braided Expandable Sleeving: Blue, Orange, Green, Brown, Slate, White
80813928	Braided Expandable Sleeving Kit – Includes (6) 125' Spools of Braided Expandable Sleeving: Red, Black, Yellow, Violet, Rose, Aqua
80813929	Braided Expandable Sleeving Kit – Includes (12) 125' Spools of Braided Expandable Sleeving: Blue, Orange, Green, Brown, Slate, White, Red, Black, Yellow, Violet, Rose, Aqua

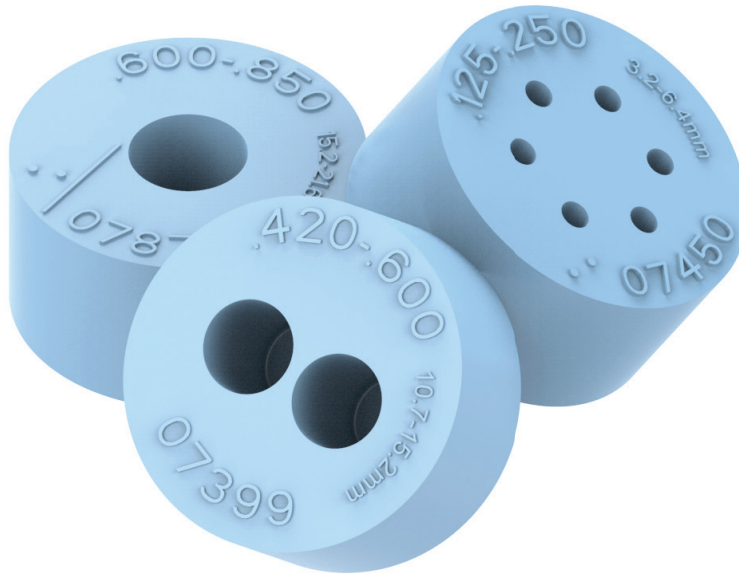

## COYOTE® SILICONE GROMMETS

**COYOTE Silicone Grommets** are manufactured from a weather-resistant silicone material that is designed to ensure a tight seal around various cable diameters and styles. They are available in single hole and multi-hole designs which can be slit to accommodate terminated or expressed cables without degrading the integrity of the seal. COYOTE Silicone Grommets are interchangeable throughout all of the COYOTE fiber optic closures and provide the ability for these closures to be re-entered and re-used.

### FEATURES AND BENEFITS

- Single and multi-hole designs available to cover cable diameter ranges from 0.093" – 1.25" (2.4 – 31.8 mm)
- Multi-hole designs allow for increased cable or drop capacity without the need to buy additional cable sealing and restraint kits
- Silicone grommet can be slit per the application procedure to accommodate terminated or expressed cables
- Eliminates the need for scuffing, adhesives, sealing tapes, or cure times
- Can be used across the COYOTE Fiber Optic Closure product line including the COYOTE LCC, In-Line RUNT, ONE, 6.5" and 9.5" Domes, Terminals, Terminal Domes, and GLC
- Designed and tested in accordance to Telcordia® GR-771-CORE, Buried, Underground; field proven since 2005
- COYOTE Silicone Grommet Kits include: (1) Grommet, (1) Cable Measure Tape, (1) Silicone Lubricant Pack, and Plugs (where applicable)

# COYOTE® SILICONE GROMMET KITS

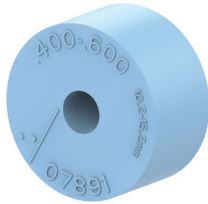

For Cable Diameters  
0.40" – 0.60" (10.2 – 15.2 mm)  
**Catalog Number: 8003691**

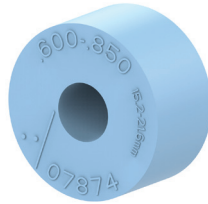

For Cable Diameters  
0.60" – 0.85" (15.2 – 21.6 mm)  
**Catalog Number: 8003692**

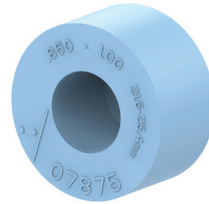

For Cable Diameters  
0.85" – 1.00" (21.6 – 25.4 mm)  
**Not for use in the COYOTE ONE**  
**Catalog Number: 8003693**

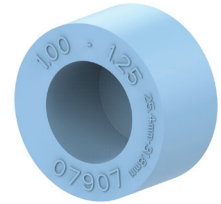

For Cable Diameters  
1.00" – 1.25" (25.4 – 31.8 mm)  
**Not for use in the COYOTE ONE or COYOTE LCC**  
**Catalog Number: 8003694**



For Cable Diameters  
0.42" – 0.60" (10.7 – 15.2 mm)  
**Catalog Number: 8003663**

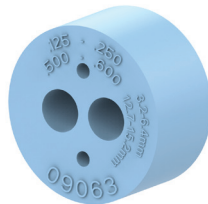

For Cable Diameters  
0.50" – 0.60" (12.7 – 15.2 mm),  
0.125" – 0.250" (3.2 – 6.4 mm),  
and Flat Drop Cable  
**Catalog Number: 8003990**

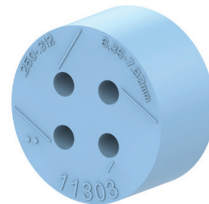

For Cable Diameters  
0.250" – 0.312" (6.4 – 7.9 mm)  
**Catalog Number: 8004065**

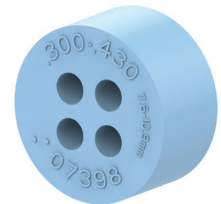

For Cable Diameters  
0.30" – 0.43" (7.6 – 10.9 mm)  
**Catalog Number: 8003664**

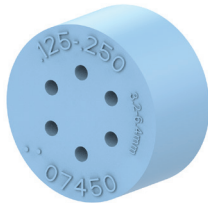

For Cable Diameters  
0.125" – 0.250" (3.2 – 6.4 mm)  
and Flat Drop Cable  
**Catalog Number: 8003665**

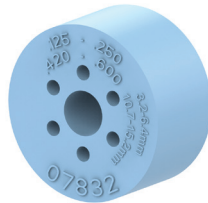

For Cable Diameters  
0.42" – 0.60" (10.7 – 15.2 mm),  
0.125" – 0.250" (3.2 – 6.4 mm),  
and Flat Drop Cable  
**Catalog Number: 8003676**

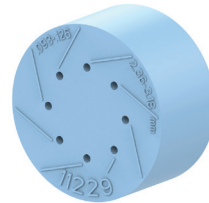

For Cable Diameters  
0.093" – 0.125" (2.4 – 3.2 mm)  
**Catalog Number: 8004094**



For Cable Diameters  
0.125" – 0.250" (3.2 – 6.4 mm)  
and Flat Drop Cable  
**Catalog Number: 8003677**

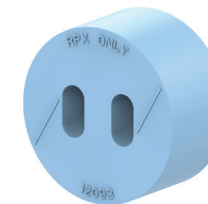

For RPX Cable ONLY  
**Catalog Number: 8004122**



For RPX Cable and Cable Diameters  
0.125" – 0.250" (3.2 – 6.4 mm)  
and Flat Drop Cable  
**For use in the COYOTE LCC for aerial applications only**  
**Catalog Number: 8004152**

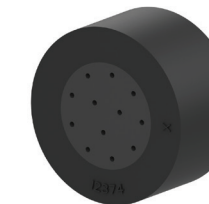

For Bow-Tie Drop Cable ONLY  
**For use in the COYOTE In-Line RUNT and 6.5" Domes with a max. flash test pressure of 5 PSI**  
**Catalog Number: 8004102**

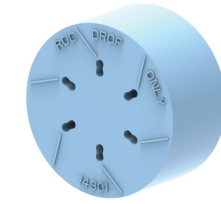

ROCTM Drop Cable  
**For Dielectric Cables Only**  
**Catalog Number: 8004240**

## COYOTE Silicone Grommet Kit Accessories

Catalog Number	Description
8003853	Silicone Lubricant Kit – Includes (6) 5 Gram Packets
8003734	Silicone Lubricant Kit – Includes (50) 5 Gram Packets
80811037	4-Port Cable Retention Bobbin Kit
80811036	6-Port Drop Cable Retention Bobbin Kit
80812163	6-Port Drop Cable Retention Bobbin and Grommet Kit - Includes (1) 6-Hole Grommet 0.125" – 0.250" and Flat Drop Cables and (1) 6-Hole Drop Cable Retention Bobbin Kit
80812928	6/8-Port Drop Cable Retention Bobbin Kit



## COYOTE® DTC4/6 MOUNTING BRACKET KITS



COYOTE DTC4/6 Aerial Mounting Bracket Kit for Strand Applications  
**Catalog Number: 8004111**

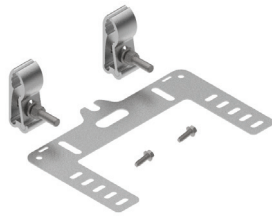

COYOTE DTC4/6 Aerial Mounting Bracket Kit for ADSS Applications  
**Catalog Number: 8004112**

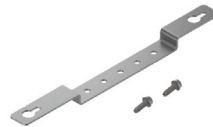

COYOTE DTC4/6 Pole/Wall Mounting Bracket Kit  
**Catalog Number: 8004109**

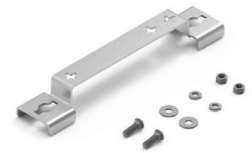

COYOTE DTC4/6 Mounting Bracket Kit for FIBERLIGN® ADSS Cable Storage Bracket Applications  
**Catalog Number: 8004172**

## COYOTE® DTC8 MOUNTING BRACKET KITS



COYOTE DTC8 Aerial Mounting Bracket Kit for Strand Applications  
**Catalog Number: 8004111**

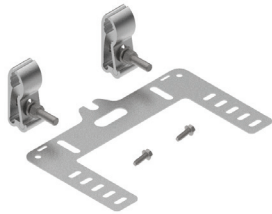

COYOTE DTC8 Aerial Mounting Bracket Kit for ADSS Applications  
**Catalog Number: 8004112**



COYOTE DTC8 Pole/Wall Mounting Bracket Kit  
**Catalog Number: 8004104**



COYOTE DTC8 Mounting Bracket Kit for FIBERLIGN® ADSS Cable Storage Bracket Applications  
**Catalog Number: 8004172**

## COYOTE® LCC MOUNTING BRACKET KITS



COYOTE LCC Aerial Mounting Bracket Kit for Strand Applications  
**Catalog Number: 8003832**



COYOTE LCC Aerial Mounting Bracket Kit for ADSS Applications  
**Catalog Number: 8003852**

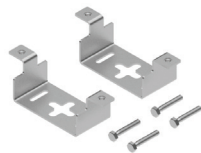

COYOTE LCC Pole/Wall Mounting Bracket Kit  
**Catalog Number: 8003830**

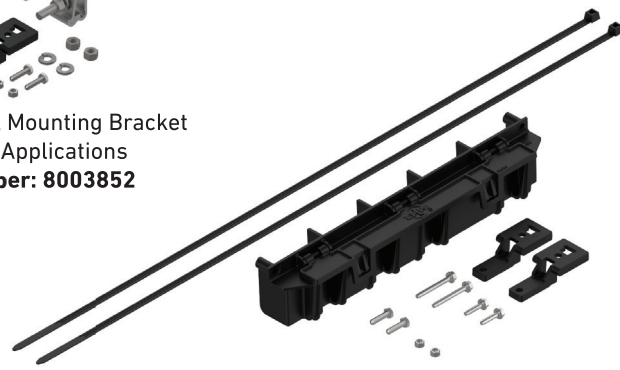

COYOTE Universal Mounting Bracket Kit for Handhole Applications  
**Catalog Number: 8003835**

## COYOTE® STP-L AND STP-XL MOUNTING BRACKET KITS



Aerial Mounting Bracket Kit - Strand Applications  
**Catalog Number: 7400033**

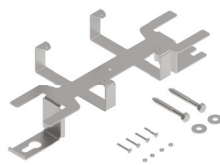

Pole/Wall Mounting Bracket with Integrated Slack Storage  
**Catalog Number: 8004214**

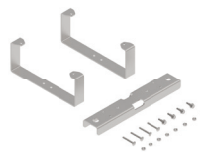

Pole/Wall Mounting Bracket  
**Catalog Number: 8004248**

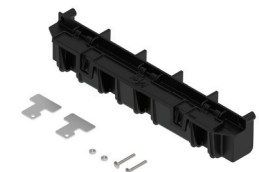

Manhole Mounting Bracket  
**Catalog Number: 80061735**

## COYOTE® IN-LINE RUNT & TERMINAL CLOSURE (SINGLE CHAMBER) MOUNTING BRACKET KITS



COYOTE In-Line RUNT & Terminal Closure (Single Chamber) Aerial Mounting Bracket Kit for Strand Applications  
**Catalog Number: 8003797**

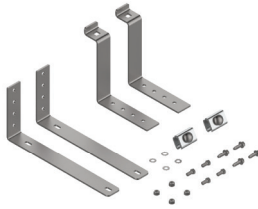

COYOTE In-Line RUNT & Terminal Closure (Single Chamber) Horizontal Mounting Bracket Kit for Strand Applications  
**Catalog Number: 8004179**

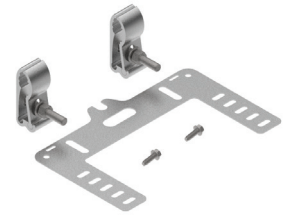

COYOTE In-Line RUNT & Terminal Closure (Single Chamber) Aerial Mounting Bracket Kit for ADSS Applications  
**Catalog Number: 8003864**

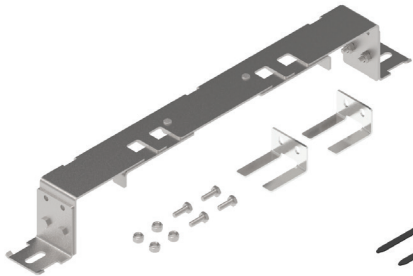

COYOTE In-Line RUNT & Terminal Closure Pole/Wall Mounting Bracket Kit  
**Catalog Number: 8003703**

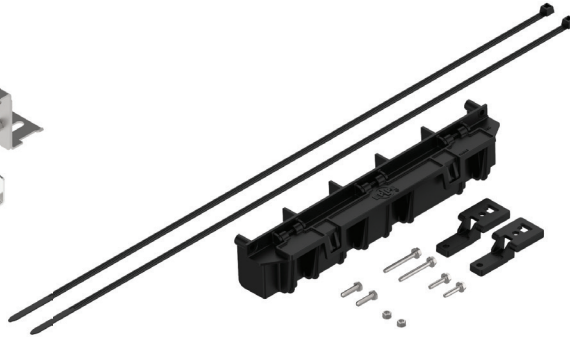

COYOTE Universal Mounting Bracket Kit for Handhole Applications  
**Catalog Number: 8003835**

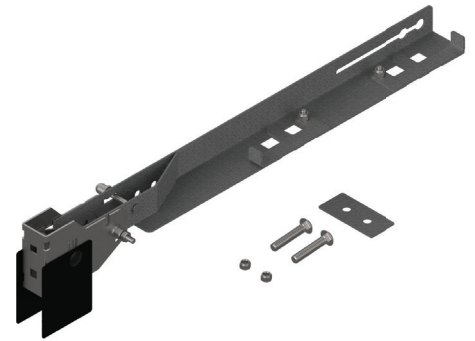

COYOTE In-Line RUNT & Terminal Closure Swing Arm for Handhole Applications  
**Catalog Number: 8003706**

## COYOTE® TERMINAL CLOSURE (DUAL CHAMBER) MOUNTING BRACKET KITS

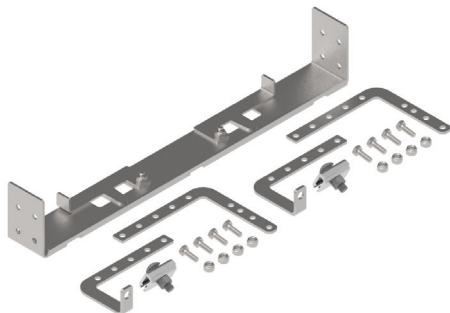

COYOTE Terminal Closure (Dual Chamber) Adjustable Offset Aerial Mounting Bracket Kit for Strand Applications  
**Catalog Number: 8003705**

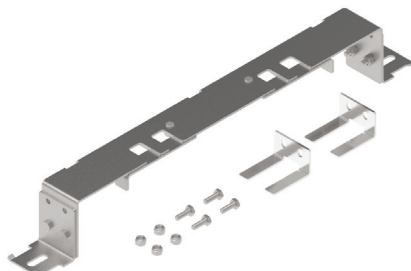

COYOTE In-Line RUNT & Terminal Closure Pole/Wall Mounting Bracket Kit  
**Catalog Number: 8003703**

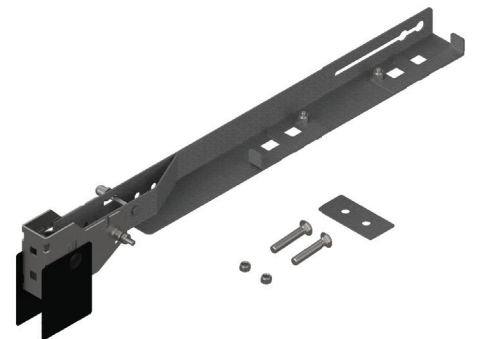

COYOTE In-Line RUNT & Terminal Closure Swing Arm for Handhole Applications  
**Catalog Number: 8003706**



## COYOTE® ONE MOUNTING BRACKET KITS



COYOTE ONE Low Clearance Aerial Mounting Bracket Kit for Strand Applications  
**Catalog Number: EVOBKT-ALC**

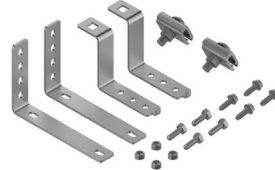

COYOTE ONE Adjustable Offset Aerial Mounting Bracket Kit for Strand Applications  
**Catalog Number: EVOBKT-AE**



COYOTE ONE Low Clearance Aerial Mounting Bracket Kit for ADSS Applications  
**Catalog Number: 8004031**

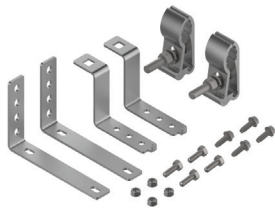

COYOTE ONE Adjustable Offset Aerial Mounting Bracket Kit for ADSS Applications  
**Catalog Number: 8004032**

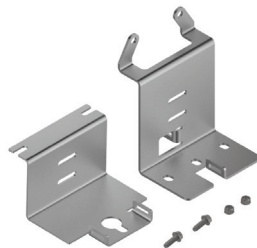

COYOTE ONE Pole/Wall Mounting Bracket Kit  
**Catalog Number: EVOBKT-PWM**

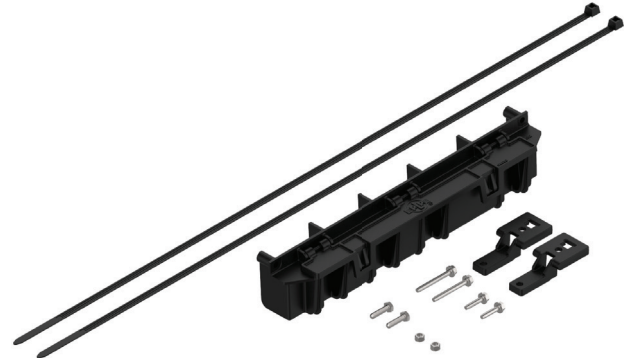

COYOTE Universal Mounting Bracket Kit for Handhole Applications  
**Catalog Number: 8003835**

## COYOTE® 6.5" DOME & TERMINAL DOME MOUNTING BRACKET KITS



COYOTE 6.5" Dome & Terminal Dome Adjustable Offset Aerial Mounting Bracket Kit for Strand Applications  
**Catalog Number: 8004035**

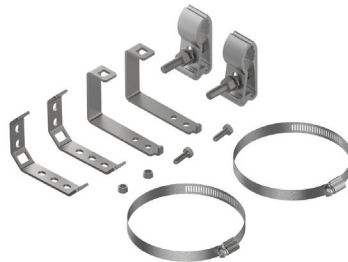

COYOTE 6.5" Dome & Terminal Dome Adjustable Offset Aerial Mounting Bracket Kit for ADSS Applications  
**Catalog Number: 8004036**

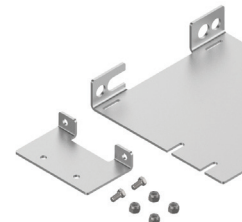

COYOTE 6.5" Dome & Terminal Dome Pole/Wall Mounting Bracket Kit  
**Catalog Number: 8003702**

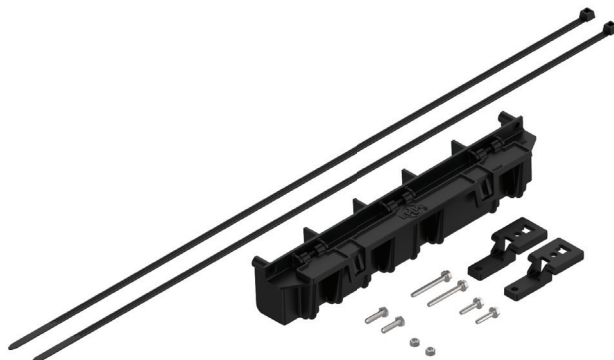

COYOTE Universal Mounting Bracket Kit for Handhole Applications  
**Catalog Number: 8003835**

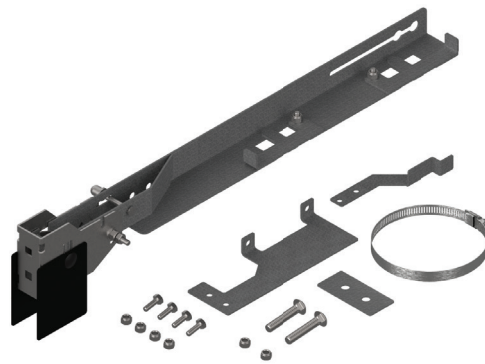

COYOTE 6.5" Dome & Terminal Dome Swing Arm for Handhole Applications  
**Catalog Number: 8003707**

# COYOTE® 9.5" DOME, HD DOME & TERMINAL DOME MOUNTING BRACKET KITS

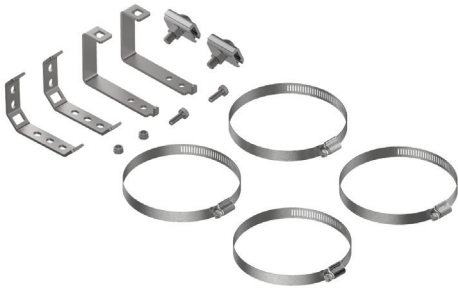

COYOTE 9.5" Dome & Terminal Dome Adjustable Offset Aerial Mounting Bracket Kit for Strand Applications  
**Catalog Number: 8004037**

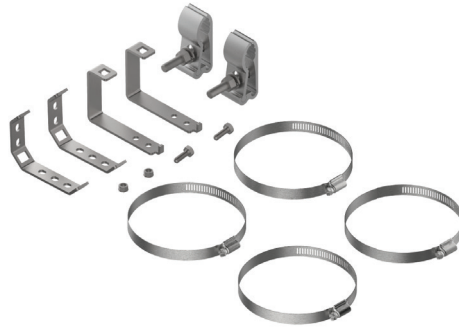

COYOTE 9.5" Dome & Terminal Dome Adjustable Offset Aerial Mounting Bracket Kit for ADSS Applications  
**Catalog Number: 8004038**

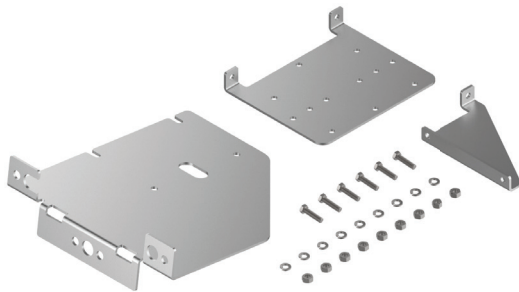

COYOTE 9.5" Dome & Terminal Dome Pole/Wall Mounting Bracket Kit  
**Catalog Number: 8003942**

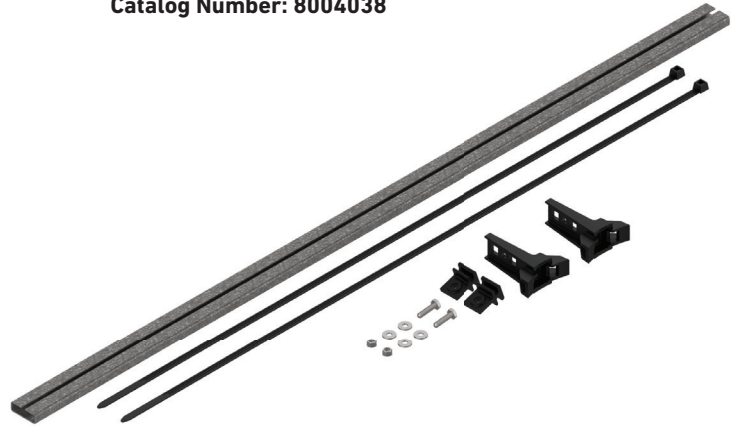

COYOTE Dome Manhole Support Bracket Kit  
**Catalog Number: 8004003**





INDEX#	Page#	Catalog Number	Page#
00065474.....	11, 17, 19	00070250.....	39
00066114.....	11, 19	00070251.....	39
00070052.....	43	00070253.....	39
00070056.....	43	00070255.....	39
00070059.....	43	00070256.....	39
00070061.....	43	00070257.....	47, 52, 120, 118
00070083.....	43	00070258.....	47, 52, 118
00070107.....	43	00070446.....	47, 52, 118
00070108.....	43	00070447.....	47, 52, 118
00070109.....	43	00070448.....	47, 52, 118
00070110.....	43	00070449.....	47, 52, 118
00070111.....	43	00070450.....	47, 52, 118
00070112.....	43	00070451.....	47, 52, 118
00070113.....	120, 118	00070452.....	47, 52, 118
00070125.....	120, 118	00070453.....	47, 52, 118
00070126.....	120, 118	00070454.....	53
00070127.....	120, 118	00070454A.....	47, 52, 118
00070128.....	120, 118	00070455.....	47, 52, 118
00070129.....	120, 118	00070455A.....	47, 52, 118
00070130.....	120, 118	00070456.....	53
00070131.....	120, 118	00070456A.....	47, 52, 118
00070132.....	120, 118	00070457.....	47, 52, 118
00070133.....	120, 118	00070457A.....	53
00070134.....	120, 118	00070458.....	47, 52, 118
00070135.....	120, 118	00070458A.....	53
00070136.....	120, 118	00070459.....	80, 86, 92
00070137.....	43	1000172.....	80, 86, 92
00070138.....	43	1000173.....	80, 86, 92
00070147.....	39	1000174.....	80, 86, 92
00070154.....	39	1000175.....	80, 86, 92
00070176.....	39	1000176.....	80, 86, 92
00070177.....	39	1000177.....	80, 86, 92
00070178.....	39	1000178.....	80, 86, 92
00070179.....	39	1000179.....	26
00070180.....	39	2872000.....	26
00070181.....	39	2872001.....	26
00070182.....	39	2872001C1E1B1.....	26
00070183.....	39	2872002.....	26
00070184.....	39	2872003.....	26
00070185.....	39	2872004.....	26
00070188.....	39	2872005.....	26
00070190.....	39	2872006.....	26
00070192.....	39	2872007.....	26
00070194.....	39	2872008.....	26
00070195.....	39	2872009.....	26
00070216.....	39	2872010.....	26
00070217.....	39	2872011.....	26
00070218.....	39	2872012.....	26
00070219.....	39	2872013.....	26
00070220.....	39	2872014.....	26
00070221.....	39	2872015.....	26
00070222.....	39	2872016.....	26
00070223.....	39	2872017.....	26
00070224.....	120, 118	2872018.....	26
00070225.....	120, 118	2872019.....	27
00070236.....	120, 118	2872099.....	27
00070237.....	120, 118	2872100.....	27
00070238.....	120, 118	2872100C1E1B1.....	27
00070239.....	120, 118	2872101.....	27
00070241.....	120, 118		

SECTION 6  
INDEX

COYOTE® FIBER OPTIC SOLUTIONS



# INDEX

Catalog Number	Page	Catalog Number	Page
6SCAPC.....	110, 136, 141	8003839.....	62, 67
6SMFC.....	141	8003843.....	25
6SMLC.....	136	8003852.....	25
6SMSC.....	110, 136, 141	8003853.....	155
6SMST.....	136, 141	8003864.....	41, 85
8SCAPC.....	110, 136, 141	8003869.....	57, 63, 91
8SMFC.....	141	8003870.....	125
8SMSC.....	110, 136, 141	8003940.....	57, 63, 91
8SMST.....	136, 141	8003941.....	57, 63, 91
12SMDSC.....	110, 136, 141	8003942.....	57, 63, 91
12SMDSCA.....	110, 136, 141	8003993.....	17, 81, 85, 90, 149
12SMLC.....	110, 136, 141	8004003.....	47, 51, 57, 63, 91
12SMLCA.....	110, 136, 141	8004031.....	47
12SMST.....	136, 141	8004032.....	47
16SMLC.....	110, 136, 141	8004034.....	129
16SMLCA.....	110, 136, 141	8004035.....	51, 91
24LCAPC.....	110, 136, 141	8004036.....	51, 91
24SMLC.....	110, 136, 141	8004037.....	57, 63, 91
7400033.....	31, 35, 156	8004038.....	57, 63, 91
8000420.....	67	8004044.....	153
8000428.....	67	8004060.....	81, 85, 90, 113
8001127.....	133, 134, 135, 137, 148, 151	8004095.....	40, 46, 51, 57, 62, 67, 113, 149
8003176.....	153	8004104.....	21
8003280.....	153	8004105.....	21
8003381.....	149	8004108.....	21
8003426.....	67	8004109.....	19
8003468.....	133, 137	8004110.....	19
8003490.....	149	8004111.....	19, 21
8003509.....	17, 81, 85, 90, 149	8004112.....	19, 21
8003702.....	51, 91	8004115.....	81, 85, 90, 101, 113
8003703.....	41, 85	8004121.....	37
8003705.....	85	8004153.....	31, 34, 81, 149
8003706.....	41, 85	8004154.....	153
8003707.....	51, 91	8004155.....	153
8003715.....	81, 85, 90, 101, 113	8004156.....	153
8003717.....	40, 46, 51, 57, 62, 67, 113, 149	8004157.....	153
8003724.....	81, 85, 90, 113	8004158.....	153
8003733.....	40	8004159.....	153
8003734.....	155	8004160.....	40, 46, 51, 57, 62, 67, 113, 149
8003797.....	41, 85	8004167.....	152
8003811.....	125	8004168.....	152
8003812.....	125, 137	8004172.....	19, 21
8003813.....	125	8004174.....	152
8003818.....	125, 137	8004175.....	152
8003824.....	125	8004176.....	152
8003825.....	125, 137	8004177.....	152
8003826.....	125, 137	8004178.....	152
8003827.....	125, 137	8004179.....	41, 85
8003828.....	125, 137	8004180.....	40
8003829.....	125	8004181.....	40
8003830.....	25, 27	8004203.....	67
8003831.....	51, 91	8004206.....	153
8003832.....	25, 27	8004207.....	153
8003833.....	51, 91	8004208.....	153
8003835.....	25, 27, 41, 47, 51, 57, 63, 85, 91	8004209.....	153

Catalog Number	Page	Catalog Number	Page
8004210	153	80061735	31, 35, 156
8004214	31, 35, 156	80801151	67
8004231	152	80803967	67
8004232	152	80803989	113
8004240	155	80805293	40, 153
8004248	31, 35, 156	80805514	133, 134, 135, 137, 148, 151
8004279	15	80805515	137, 148, 151
8004284	31, 34	80806033	133, 134, 137, 147, 150
8006876	23	80806439	153
8006877	50	80807114	147, 150
8006878	50	80807332	51, 90
8006914	23	80807701	137, 147, 150
8006944	49	80807794	40
8006945	49	80807972	81, 85, 90, 101, 113
8006947	53	80807989	153
8006951	39	80807991	153
8006952	39	80808187	17, 81, 85, 90, 149
8006953	83	80808508	125
8006954	83	80808613	113, 149
8006955	83	80808618	125, 137
8006956	70, 84	80808633	25
8006991	84	80808639	40
8006992IV	131	80808651	51, 57, 62, 67, 90, 113
8006992W	131	80808853	125
8006993	83	80808878	51, 57, 90
80061029	84	80808916	125
80061045	131	80808945	40, 46, 49, 51, 55, 57, 71, 72, 73, 83, 85, 87, 90, 99, 105, 106, 113, 123, 124, 125, 147, 150
80061049	39	80808960	125
80061055	56	80808982	125
80061056	56	80808997	51, 90
80061057	56	80809054	40
80061067	83	80809205	46, 51, 57, 62, 67, 90, 113
80061172	70	80809781	108
80061173	70	80809788	113
80061200	51	80809851	25
80061201	57, 62, 67	80809958	40, 46, 49, 51, 55, 57, 71, 72, 73, 83, 85, 87, 90, 105, 106, 113, 23, 124, 125, 134, 147, 150
80061322	13	80810072	46
80061323	13	80810086	50, 51, 56, 57, 72, 73, 88, 90, 107, 108, 113, 148, 151
80061335	57	80811036	25, 46, 51, 57, 90, 113, 155
80061406	59	80811037	25, 46, 51, 57, 90, 113, 155
80061407	59	80811123	40
80061408	60	80811124	40
80061409	60	80811125	40
80061477	57, 62, 90	80811126	40
80061488	61	80811135	129
80061495	57	80811215	129
80061500	62, 67	80811216	129
80061594	59	80812152	129
80061637	65, 66	80812163	155
80061637FR	65, 66	80812456	21
80061638	65, 66	80812533	17
80061638FR	65, 66	80812558	143
80061639	65, 66	80812559	143
80061639FR	65, 66	80812560	143
80061728	127		
80061729	127		



Catalog Number	Page	Catalog Number	Page
80812618	153	80814576	34
80812784B	137	80814614	34
80812785B	137	80814649	51, 85, 90, 99, 147, 150
80812881	153	80814650	51, 90, 99, 148, 151
80812916	21	80821085	17
80812928	46, 51, 57, 90, 113, 155	800011830	84
80812983	143	800011839	84
80812985	143	800012002	83
80813121	59, 60, 62, 65, 67	800012003	83
80813122	59, 60, 62, 65, 67	800012140	84
80813123	59, 60, 61, 62, 65, 67	800012605	84
80813124	62, 67	800013831	148
80813125	62	800013853	69
8081315240, 46, 49, 51, 55, 57, 71, 72, 73, 83, 85, 87, 90, 99, 105,	106, 113, 123, 124, 125, 147, 150	800013854	69
80813227	153	800013856	71
80813238	99	800013911	69
80813267	62, 67	800013979	129, 143
80813301	61, 62, 67	800013980	129, 143
80813361	62	800014109	129, 143
80813362	17, 149	800014110	129, 143
80813501	112, 144	800014114	129
80813502	112, 144	800014115	129
80813503	112, 144	800014149B	137
80813504	112, 144	800014150B	137
80813505	112, 144	800015055	143
80813506	112, 144	800015236	57, 62, 67
80813507	112, 144	<b>C</b>	
80813508	112, 144	COY1-001	45
80813518	152	COY1-002	45
80813593	141	COY1U-000	45
80813594	141	COYACE	129
80813595	100, 141	COYACE-000	129
80813596	100, 141	COYACE-001	129
80813597	141	COYACE-002	129
80813598	141	COYACE-003	129
80813599	100, 141	COYACE-004	129
80813600	100, 141	COYACE-005	129
80813611	129	COYACE-006	129
80813612	129	COYACE-007	129
80813613	129	COYACE-008	129
80813614	129	COYBGC-001	27
80813680	153	COYBGC-002	27
80813747	31, 34, 81	COYBGC-003	27
80813770	62, 67	COYBGC-003	27
80813779	59, 60, 62, 65, 67	COYBGC-001	27
80813787	40	COYBGC-002	27
80813928	153	COYBGC-003	27
80813929	153	COYBGC-001	27
80813988	35, 100	COYBGC-002	27
80813989	35, 100	COYBGC-003	27
80813990	35, 100	COYBGC-001	27
80813991	35, 100	COYBGC-002	27
80814403	127	COYBGC-003	27
80814404	127	COYBGC-001	27
80814405	99	COYBGC-002	27
80814406	99	COYBGC-003	27
80814575	34, 81	COYBGC-001	27
		COYBGC-002	27
		COYBGC-003	27
		COYD617U-000	49
		COYD622-000	50
		COYD919B-000	55
		COYD919R-000	55
		COYD919U-000	55
		COYD928U-000	56
		COYDEN2-SPL	118
		COYDEN2-XC	118
		COYDEN3-SPL	119
		COYDEN3-XC	119
		COYDEN5-CSTE2	121
		COYDEN5-CSTE4	121

Catalog Number	Page	Catalog Number	Page
COYDEN5-SPL .....	120	COYGLC-F6-000 .....	107
COYDRC2-001 .....	15	COYGLC-F6-100 .....	107
COYDRC2-002 .....	15	COYGLC-F7-000 .....	108
COYDRC4-001 .....	15	COYGLC-F7-100 .....	108
COYDRC4-002 .....	15	COYGLC-S1-000 .....	109
COYDTC-001 .....	17	COYGLC-S2-000 .....	109
COYDTC-002 .....	17	COYGLC-S3-000 .....	109
COYDTC-003 .....	17	COYLCC-F001 .....	25
COYDTC-004 .....	17	COYLCC-F002 .....	25
COYDTC-009 .....	17	COYLCC-F004 .....	25
COYEPFIX1 .....	51, 57, 62, 67, 90	COYLCC-F005 .....	25
COYGLC-1X8-LCA .....	110	COYLCC-F006 .....	25
COYGLC-1X8-LCU .....	110	COYLCC-F008 .....	25
COYGLC-1X8-SCA .....	110	COYLCC-F012 .....	25
COYGLC-1X8-SCU .....	110	COYLCC-F014 .....	25
COYGLC-1X16-LCA .....	110	COYLCC-F015 .....	25
COYGLC-1X16-LCU .....	110	COYMPC-000 .....	123
COYGLC-1X16-SCA .....	110	COYMPC-001 .....	123
COYGLC-1X16-SCU .....	110	COYMPC-002 .....	123
COYGLC-1X32-LCA .....	110	COYMPC-004 .....	123
COYGLC-1X32-LCU .....	110	COYMPC-005 .....	123
COYGLC-1X32-SCA .....	110	COYMPC-006 .....	123
COYGLC-1X32-SCU .....	110	COYMPC-D000 .....	124
COYGLC-4FB-LCA .....	112	COYMPC-D001 .....	124
COYGLC-4FB-LCU .....	112	COYMPC-D005 .....	124
COYGLC-4FB-SCA .....	112	COYPED6-BLKHDTRM .....	101
COYGLC-4FB-SCU .....	112	COYPED6-CWH .....	101
COYGLC-8FB-LCA .....	112	COYPED6-FLIPTK .....	99
COYGLC-8FB-LCU .....	112	COYPED6-IXC .....	100
COYGLC-8FB-SCA .....	112	COYPED6-MBPN .....	95
COYGLC-8FB-SCU .....	112	COYPED6-MBPS .....	95
COYGLC-12FB-LCA .....	112	COYPED6-MD5 .....	103
COYGLC-12FB-LCU .....	112	COYPED6-MD7 .....	103
COYGLC-12FB-SCA .....	112	COYPED6-UON .....	95
COYGLC-12FB-SCU .....	112	COYPED6-UOS .....	95
COYGLC-16FB-LCA .....	112	COYPED8-BASE .....	102
COYGLC-16FB-LCU .....	112	COYPED8-BLKHDTRM .....	101
COYGLC-16FB-SCA .....	112	COYPED8-DOME .....	102
COYGLC-16FB-SCU .....	112	COYPED8-FLIPTK .....	99
COYGLC-32FB-LCA .....	112	COYPED8-GRDPLT .....	102
COYGLC-32FB-LCU .....	112	COYPED8-LGTK .....	99
COYGLC-32FB-SCA .....	112	COYPED8-MBPN .....	96
COYGLC-32FB-SCU .....	112	COYPED8-MBPS .....	96
COYGLC-B-000 .....	108	COYPED8-UON .....	96, 97
COYGLC-F1-000 .....	105	COYPED8-UOS .....	96, 97
COYGLC-F1B-000 .....	105	COYPED10-BLKHDTRM .....	101
COYGLC-F1B-100 .....	105	COYPED10-EXBT .....	101
COYGLC-F2-000 .....	105	COYPED10-MFDON .....	97
COYGLC-F2B-000 .....	105	COYPED10-MFDOS .....	97
COYGLC-F2B-100 .....	105	COYPED10-MFSTPN .....	97
COYGLC-F3-000 .....	106	COYPED10-MFSTPS .....	97
COYGLC-F3B-000 .....	106	COYPED810-MD5 .....	103
COYGLC-F3B-100 .....	106	COYPED810-MD7 .....	103
COYGLC-F4-000 .....	106	COYPED810-TM .....	101
COYGLC-F4B-000 .....	106	COYPED-AS32 .....	103
COYGLC-F4B-100 .....	106	COYPED-AS42 .....	103
COYGLC-F5-000 .....	107	COYPED-BLKHD12P .....	100
COYGLC-F5-100 .....	107	COYPED-BLKHD24P .....	100



Catalog Number

Page

COYPED-BNDBRD .....	103	LGSR4-5 .....	149
COYPED-CRB .....	103	LGSR8-5 .....	17, 149
COYPED-DRPCHNL .....	103	LGSR8-50 .....	149
COYPED-DRPGMT .....	103	LGSTL1x32PC .....	148
COYPED-FBRCLIP .....	103	LGSTL-SPLIT .....	148
COYPED-FBRTAB .....	103	LGSTR144 .....	40, 46, 49, 51, 55, 57, 83, 85, 87, 90, 105, 106, 113, 123, 124, 125, 147, 150
COYPED-GRDPLTEX .....	103	LGSTR216 .....	50, 51, 56, 57, 88, 90, 107, 108, 113, 148, 151
COYSP1X2 .....	145	LGSTS1x32PC .....	147
COYSP1X2SCA .....	35, 145	LGSTS1x816PC .....	147
COYSP1X4 .....	145	lgsts72 .....	50, 56, 72, 73, 88
COYSP1X4SCA .....	35, 145	LGSTS72 .....	51, 57, 72, 90, 99, 107, 108, 113, 148, 151
COYSP1X8 .....	145	LGSTS-SPLIT .....	147
COYSP1X8SCA .....	35, 145	<b>P</b>	
COYSP1X16 .....	145	P6FC3 .....	143
COYSP1X16SCA .....	35, 145	P6LC3 .....	136, 143
COYSP1X32 .....	145	P6LCA3 .....	136, 143
COYSP1X32SCA .....	145	P6SCA3 .....	136, 143
COYTD617B4-000 .....	87	P6SCU3 .....	136, 143
COYTD622B4-000 .....	88	P6ST3 .....	136, 143
COYTD919B4-000 .....	87	P12FC3 .....	143
COYTD928B4-000 .....	88	P12LC3 .....	136, 143
COYTRM-2PK-SCA .....	85, 111, 142	P12LCA3 .....	136, 143
COYTRM-2PK-SCA-SB .....	35, 81, 111, 142	P12SCA3 .....	136, 143
COYTRM-2PK-SCU .....	111, 142	P12SCU3 .....	136, 143
COYTRM-2PK-SCU-SB .....	35, 111, 142	P12ST3 .....	136, 143
COYTRM-3PK-SCA .....	85, 111, 142	<b>R</b>	
COYTRM-3PK-SCA-SB .....	35, 81, 111, 142	RDC2 .....	134, 137
COYTRM-3PK-SCU .....	111, 142	RDC3 .....	134, 137
COYTRM-3PK-SCU-SB .....	111	RDC6 .....	134, 137
COYTRM-3PK-SCU-SB .....	35, 142	RDC12 .....	134, 137
COYTRM-4PK-LCA .....	111, 142	RDC12X .....	135, 137
COYTRM-4PK-LCA-SB .....	35, 111, 142	RDC24 .....	135, 137
COYTRM-4PK-LCU .....	111, 142	RDC36 .....	135, 137
COYTRM-4PK-LCU-SB .....	35, 111, 142	<b>S</b>	
COYTRM-4PK-SCA .....	85, 111, 142	STP-L3-48-001 .....	30
COYTRM-4PK-SCA-SB .....	35, 81, 111, 142	STP-L3-48-002 .....	30
COYTRM-4PK-SCU .....	111, 142	STP-L3-96-001 .....	30
COYTRM-4PK-SCU-SB .....	35, 111, 142	STP-L3-96-002 .....	30
CXD617B-001 .....	71	STP-L3T .....	77
CXD617U-001 .....	72	STP-L3T-XP-24-001 .....	78
CXD622B-001 .....	72	STP-L3T-XP-24-002 .....	78
CXD622U-001 .....	73	STP-L4-48-001 .....	30
CXD91901 .....	73	STP-L4-48-002 .....	30
<b>E</b>		STP-L4-48-003 .....	30
EVOBKT-AE .....	47	STP-L4-96-001 .....	30
EVOBKT-ALC .....	47	STP-L4-96-002 .....	30
EVOBKT-PWM .....	47	STP-L4-96-003 .....	30
<b>L</b>		STP-L4T .....	77
LGRS1-25B .....	149	STP-L4T-XP-24-001 .....	78
LGRS1-25OR .....	149	STP-L4T-XP-24-002 .....	78
LGRS6-25B .....	149	STP-L4T-XP-24-003 .....	78
LGRS6-25G .....	149	STP-XL6-48-001 .....	34
LGRS6-25OR .....	149	STP-XL6-96-001 .....	34
LGRSF2-25 .....	149	STP-XL6T-XP-48-001 .....	80
LGSR3-5 .....	17, 149	STP-XL6T-XP-48-002 .....	80
LGSR3-50 .....	149		

STP-XL6T-XP-96-001 .....	80
STP-XL6T-XP-96-002 .....	80
STP-XL8-48-002 .....	34
STP-XL8-48-003 .....	34
STP-XL8-96-002 .....	34
STP-XL8-96-003 .....	34
STP-XL8T-XP-48-002 .....	80
STP-XL8T-XP-48-003 .....	80
STP-XL8T-XP-96-002 .....	80
STP-XL8T-XP-96-003 .....	80
STPXLEK-001 .....	31, 34, 81
STPXLTk-002 .....	31, 34, 81, 98, 99
<b>W</b>	
WDC2 .....	133, 137
WDC4 .....	133, 137
WDC8 .....	133, 137
WDC12 .....	133, 137



GLOBAL HEADQUARTERS  
660 BETA DRIVE  
CLEVELAND, OHIO 44143

+1 440 461 5200  
INFO@PLP.COM  
PLP.COM

© 2024 Preformed Line Products  
Printed in U.S.A.  
CO-CA-1004-20  
05.26.1.5C