

COYOTE® 8" PEDESTAL

COYOTE Pedestals provide easy customization options to adapt to your fiber or copper splicing needs at each location in your network. Each pedestal is pre-assembled and can be configured to accept various fiber optic splice tray types, fiber or copper terminals, fiber cross-connect bulkheads, or management brackets for copper splices. In addition, the organizer can be removed and a slotted metal back plane can be inserted into the base to attach fiber closures and cabinets, such as the COYOTE PedBox®, to provide additional protection for your splices. The versatility that COYOTE Pedestals provide allow you to create the network you desire.

FEATURES AND BENEFITS

- Each pedestal size is pre-assembled with a base, automatic locking cover, and internal organizer with a grounding busbar
- Cover and base are manufactured out of a UV/FR stabilized material to withstand weathering
- Split base design for easy installation around pre-installed duct/cables and replacement of existing pedestals
- Automatic cover locking system (patent pending)
- Grounding busbar isolates connections and is equipped with a ground wire terminal (#4 – #10)
- Organizer can be configured for various fiber and copper applications - splicing, terminals, and cross-connect applications
- Organizer can accommodate COYOTE Flip Trays, LITE-GRIP® Splice Trays, and Legacy Splice Trays
- All fasteners are constructed of stainless steel to prohibit corrosion and can be secured or loosened with common tools (216 can wrench, 1/4" nut driver, or Philips screwdriver)
- Designed and tested in accordance with GR-13-CORE requirements



PEDESTAL BASE AND COVER

- Base halves can be easily removed and attached by partially loosening each side bolt
- Ground level indicator line located on the front and rear of the base
- Drop cable entrance allows for shallower trenching of drop cables
- Drop cable entry port located on each side of the base allows a temporary drop cable to be installed without having to trench
- Retention channels molded into the base help prevent the pedestal from ground heave
- Stake channel, located on the rear of base, allows any size pedestal stake to be attached to the base when required
- Foam block protects drop cables as they are routed through the drop channel of the base
- Patent pending automatic cover locking system allows quick access inside the pedestal with a quarter turn of a 216 can wrench

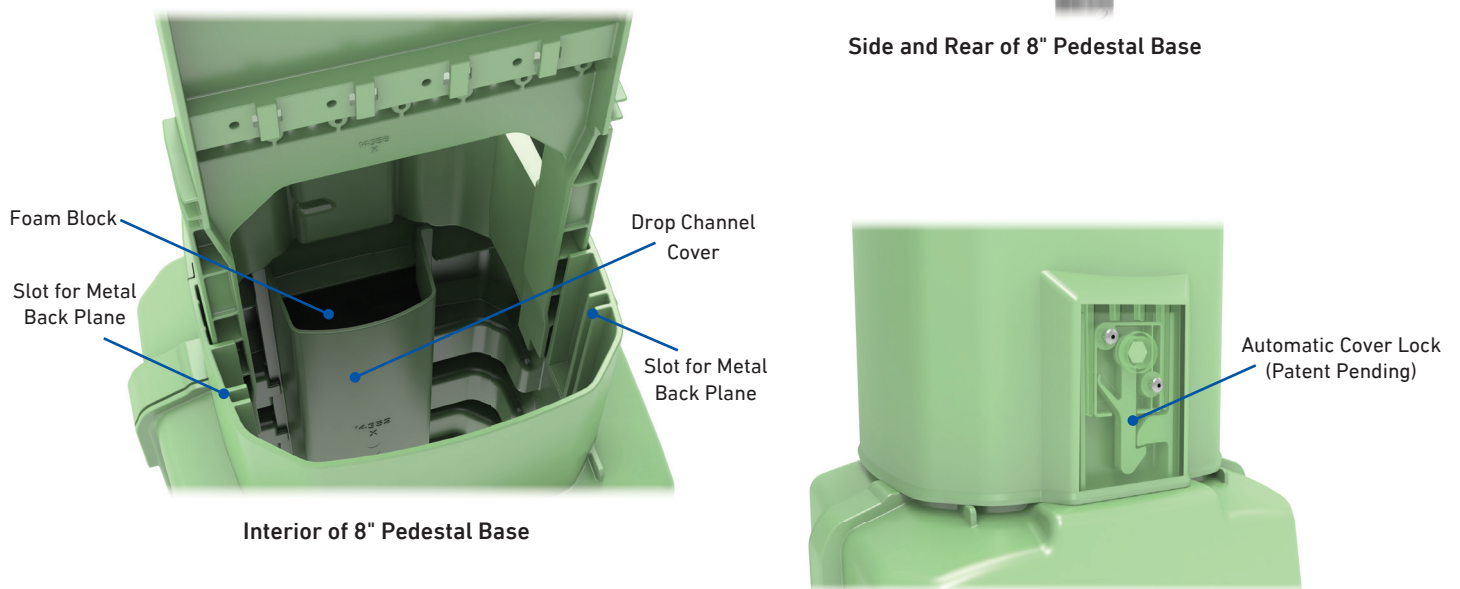
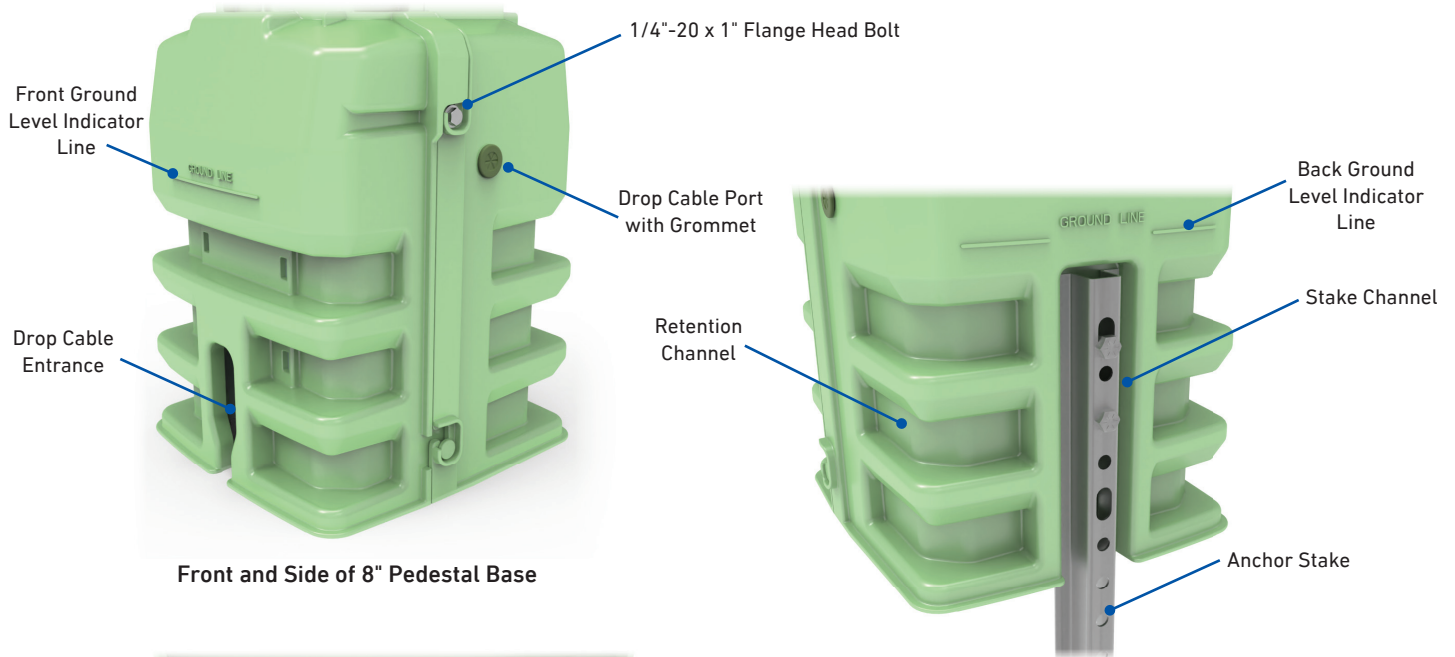

PEDESTAL GROUNDING BUSBAR AND ORGANIZER

- Can secure 4 incoming and 6 outgoing cables to the organizer
- Anti-rotation features molded into the organizer and plastic cable retention brackets
- Grounding busbar allows up to 7 isolated connections and is equipped with a ground wire terminal that accepts up to a #4 ground wire
- Slotted mid plane of the organizer allows for fiber and copper terminals to be installed directly to the organizer
- Pass through slots located on the top and bottom of the organizer allow cables or buffer tubes to be routed to either side of the organizer
- Plastic removable retention tabs and routing clips for routing and managing cables or buffer tubes

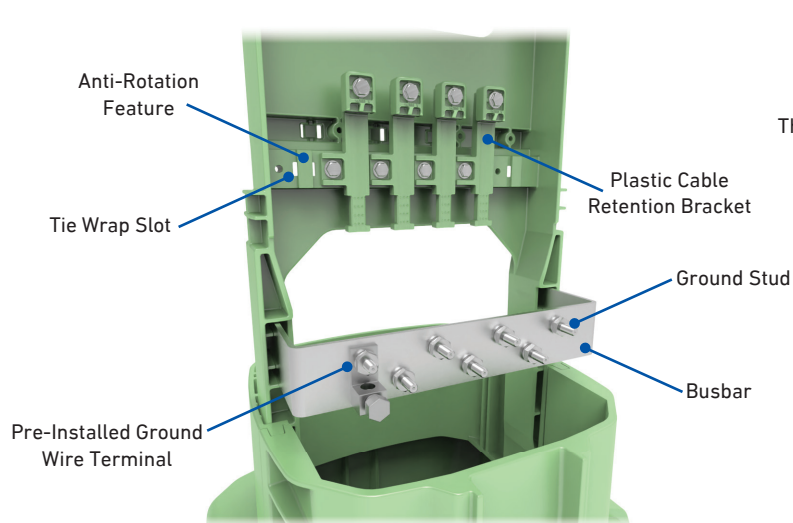

8" Pedestal Cable Retention and Grounding Busbar

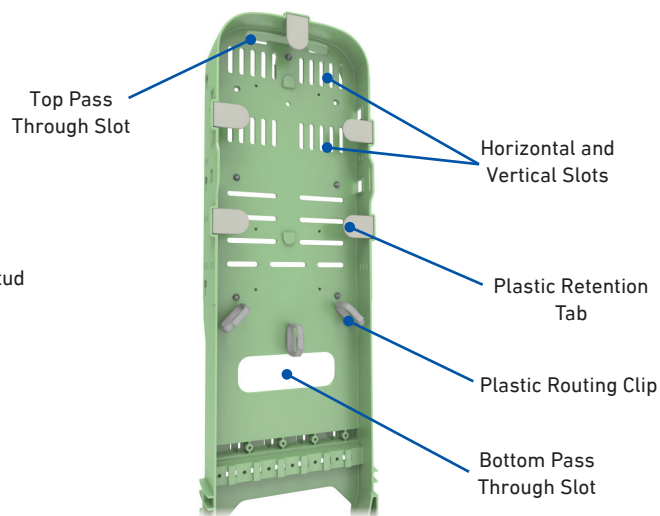

Front of 8" Pedestal Organizer

DIMENSIONS

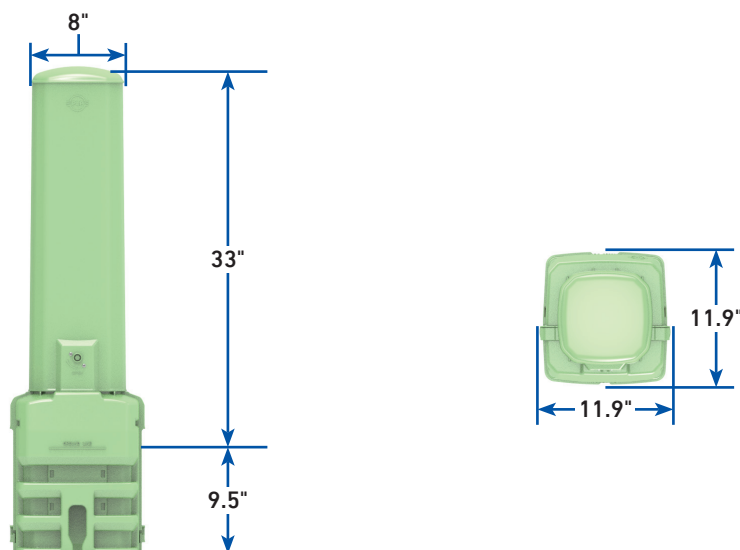



COYOTE® 8" PEDESTAL WITH UNIVERSAL ORGANIZER

- Can be configured with COYOTE® Flip Trays, LITE-GRIP® Splice Trays and Legacy Splice Trays
- Internal Cross-Connect Features for all splice tray configurations
- Ability to place hardened terminals including up to 8-Port MST and Corning Evolv® Terminals
- Can place routing handles to properly store/waterfall copper splices.

COMPONENTS

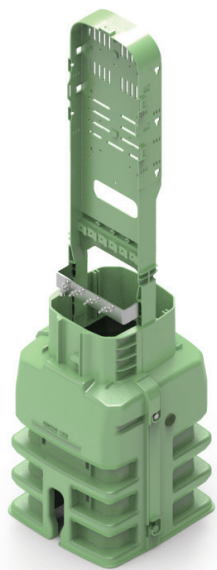

COYOTE® 8" Pedestal, Universal Organizer w/ Busbar and Split Base



COYOTE® 8" Pedestal, Dome w/ Automatic Lock



Small Parts Bag

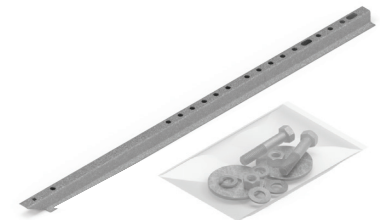

Anchor Stake Kit (Optional)



Cable Retention Kit

COYOTE® 8" Pedestal Kits with Universal Organizers

Catalog Number	Description
COYPED8-UOS	COYOTE® 8" Pedestal, Universal Organizer with Anchor Stake – Includes (1) 8" Pedestal, Universal Organizer with Busbar and Split Base, (1) Dome, (1) Small Parts Bag, (1) Cable Retention Kit, and (1) Anchor Stake with Attachment Hardware
COYPED8-UON	COYOTE® 8" Pedestal, Universal Organizer without Anchor Stake – Includes (1) 8" Pedestal, Universal Organizer with Busbar and Split Base, (1) Dome, (1) Small Parts Bag, and (1) Cable Retention Kit



COYOTE® 8" PEDESTAL WITH METAL BACK PLANE

- Can accommodate most copper and fiber terminals.
- Allows for ample space concerning fiber bend radius of MST/ Hardened Drops
- Can accommodate COYOTE® PEDBOX® and other distribution splice enclosures

COMPONENTS

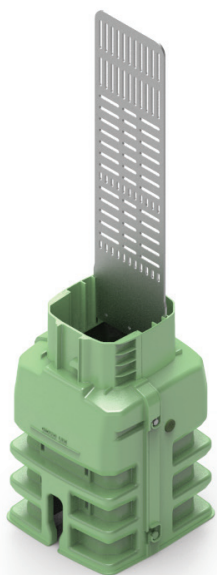

COYOTE® 8" Pedestal,
Metal Back Plane and
Split Base



COYOTE® 8" Pedestal,
Dome w/ Automatic Lock

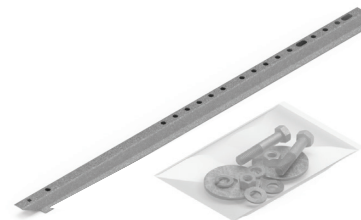

Anchor Stake Kit
(Optional)

COYOTE® 8" Pedestal Kits with Metal Back Plane

Catalog Number	Description
COYPED8-MBPS	COYOTE® 8" Pedestal, Metal Back Plane with Anchor Stake – Includes (1) 8" Pedestal, Metal Back Plane and Split Base, (1) Dome, and (1) Anchor Stake with Attachment Hardware
COYPED8-MBPN	COYOTE® 8" Pedestal, Metal Back Plane without Anchor Stake – Includes (1) 8" Pedestal, Metal Back Plane and Split Base, and (1) Dome



FIBER SPLICING

COYOTE® LITE-GRIP® Splice Trays for Fiber Splicing

The LITE-GRIP tray kit allows for the installation of LITE-GRIP or legacy COYOTE trays into the pedestal. Both the LITE-GRIP and legacy splice trays are injection molded and have hinged, clear plastic cover to protect and allow for visible inspection of the fibers. The LITE-GRIP trays feature retention sleeves that are designed to grip buffer tubes, pigtails, or transport tubing without over compression during installation.

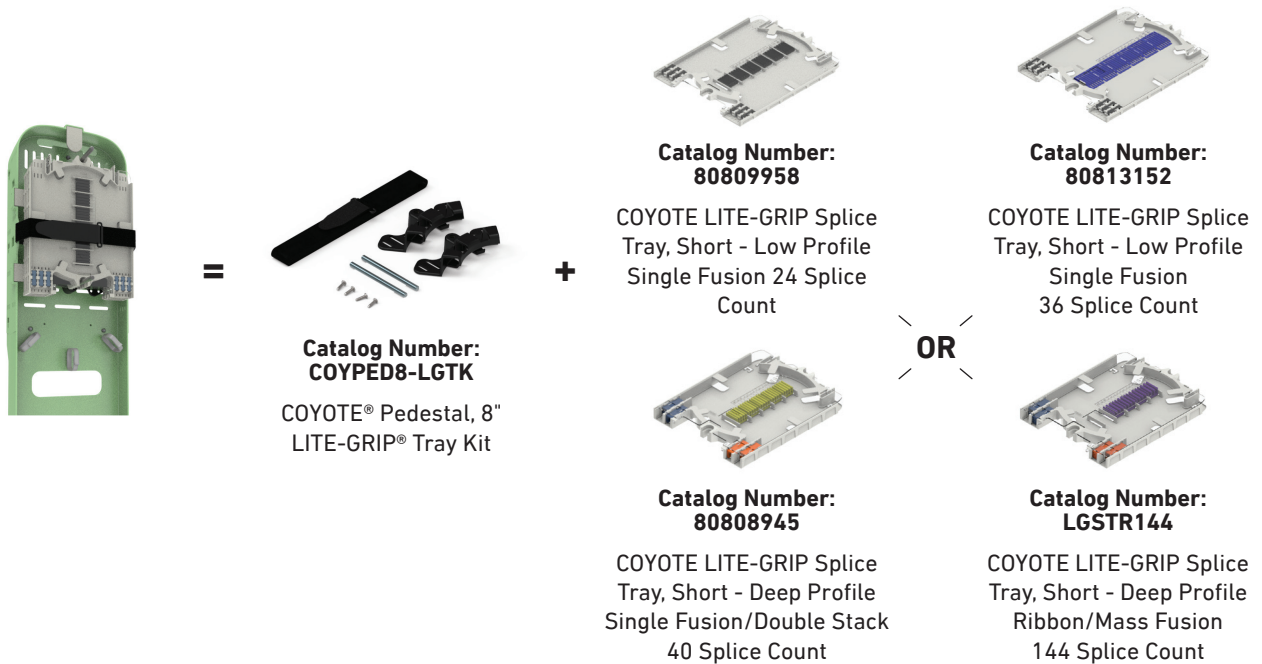

COYOTE® Flip Trays for Fiber Splicing

The flip tray installation kit allows for the installation of the COYOTE Flip Trays into the pedestal. The flip trays can be hinged down to gain access to stored buffer tubes or removed from the organizer to allow for multiple splicers to work simultaneously outside of the pedestal organizer. The trays are stored in a locked and protected state.

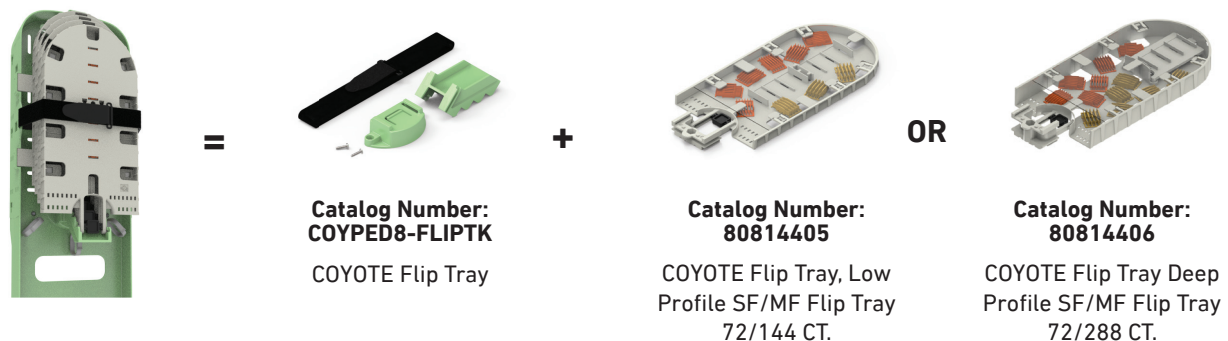



COYOTE® SPLICE TRAYS

COYOTE® Splice Tray Capacity Chart for COYOTE 8" Pedestal

PLP Catalog Number	Description	Image	Splice Type	Max Trays per Closure	Closure Max Splice Capacity
80809958	LITE-GRIP® Short Low Profile (24 CT)		Single Fusion (Single Stack)	6	144
80813152	LITE-GRIP Short Low Profile (36 CT)		Single Fusion (Single Stack)	6	216
80808945	LITE-GRIP Short Deep Profile (40 CT)		Single Fusion (Double Stack)	3	120
LGSTR144	LITE-GRIP Short Deep Profile (144 CT)		Mass Fusion/ Ribbon	3	432
80806033	Legacy Standard Profile (12 Splice Count)		Single Fusion (Single Stack)	4	48
80807701	Legacy Low Profile (12 Splice Count)		Single Fusion (Single Stack)	6	72
80807114	Legacy Deep Profile (72 Splice Count)		Single Fusion (Double Stack)	3	216
80814405	Flip Thin Profile (72 CT SF / 144 CT MF)		Single Fusion (Double Stack) OR Mass Fusion/ Ribbon	4	288 SF 288 MF
80814406	Flip Deep Profile (72 CT SF / 288 CT MF)		Single Fusion (Double Stack) OR Mass Fusion/ Ribbon	2	144 SF 576 MF



FIBER SPLICING AND PATCHING

Cross-Connect Bulkhead

The internal cross-connect kit when equipped into the pedestal offers a protective cover over the adapters to prevent tampering of the incoming connections. Each kit comes with (2) 24 CT. splice trays that are located on the underside of the organizer to keep them separate from incoming drop connections. This organizer should be used when preconnectorized drops are being used. The entire internal cross-connect kit snaps into the universal organizer to keep the splices protected from tampering.

The patch tray is installed in conjunction with the COYOTE Flip Trays and provides plug and play technology with industry standard connectors. The patch tray can be equipped with up to 24 SC or 48 LC connections. The patch tray can be hinged down and locked into place to provide easy access to connectors to redirect services without having to re-splice each time.



=

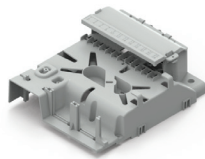

**Catalog Number:
COYPED8-IXC**

COYOTE® Internal
Cross-Connect Kit

+



**Catalog Number:
80813595**

SC/APC Duplex Adapter
Flanged Adapter Required
Pack of 8

OR

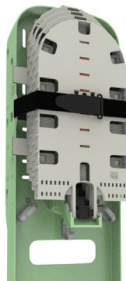

=



**Catalog Number:
COYPED8-FLIPTK**

COYOTE® Flip Tray
Parts Bag

+

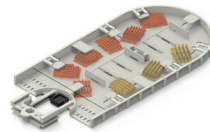

**Catalog Number:
80814405**

COYOTE® Flip Tray, Thin
Profile SF/MF Flip Tray
72/144 CT.

+

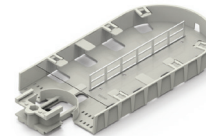

**Catalog Number:
80814463**

COYOTE® Flip Tray, Deep
Profile Patch Tray
(Max 12 Duplex SC)

+



**Catalog Number:
80813988**

SC/APC Duplex
Flangeless Adapter Required
Pack of 6

Adapter Bulkhead

The adapter bulkhead can be installed on the universal organizer on the opposite side as the splice trays. This will allow for flexibility in your network design while also providing a plug and play solution. Up to 24 SC or 48 LC connections can be installed using **Catalog Number: COYPED-BLKHD24P**. Any splice tray type is compatible with this adapter bulkhead.



=



**Catalog Number:
COYPED-BLKHD12P**

COYOTE® Pedestal XC
Bulkhead, 12-Port

OR

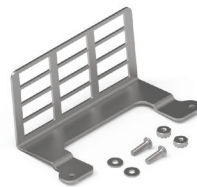

**Catalog Number:
COYPED-BLKHD24P**

COYOTE® Pedestal XC
Bulkhead, 24-Port

+



**Catalog Number:
80813988**

SC/APC Duplex
Flangeless Adapter Required
Pack of 6



COYOTE® CROSS-CONNECT ACCESSORIES



SC/APC Duplex Adapter

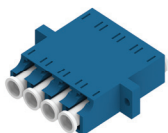

LC/UPC Quad Adapter



SC/APC Duplex Flangeless Adapter

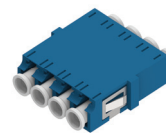

LC/UPC Quad Flangeless Adapter

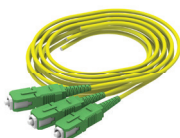

3-Pack of 2 mm Jacketed SC/APC Pigtails with Short Boot Connectors



4-Pack of 2 mm Jacketed LC/UPC Pigtails with Short Boot Connectors



COYOTE® Pre-Connectorized Splitter - 1x8 SC/APC

COYOTE Pedestal Cross-Connect Accessories

Catalog Number	Description
80813595	Adapter Kit – Includes (8) SC/APC Duplex Adapters
80813596	Adapter Kit – Includes (8) SC/UPC Duplex Adapters
80813599	Adapter Kit – Includes (8) LC/APC Quad Adapters
80813600	Adapter Kit – Includes (8) LC/UPC Quad Adapters
80813988	Flangeless Adapter Kit – Includes (6) SC/APC Duplex Flangeless Adapters
80813989	Flangeless Adapter Kit – Includes (6) SC/UPC Duplex Flangeless Adapters
80813990	Flangeless Adapter Kit – Includes (6) LC/APC Quad Flangeless Adapters
80813991	Flangeless Adapter Kit – Includes (6) LC/UPC Quad Flangeless Adapters
COYTRM-2PK-SCA-SB	Pigtail Kit – Includes (2) SC/APC 2 mm Jacketed Pigtails with Short Boot Connectors
COYTRM-2PK-SCU-SB	Pigtail Kit – Includes (2) SC/UPC 2 mm Jacketed Pigtails with Short Boot Connectors
COYTRM-3PK-SCA-SB	Pigtail Kit – Includes (3) SC/APC 2 mm Jacketed Pigtails with Short Boot Connectors
COYTRM-3PK-SCU-SB	Pigtail Kit – Includes (3) SC/UPC 2 mm Jacketed Pigtails with Short Boot Connectors
COYTRM-4PK-SCA-SB	Pigtail Kit – Includes (4) SC/APC 2 mm Jacketed Pigtails with Short Boot Connectors
COYTRM-4PK-SCU-SB	Pigtail Kit – Includes (4) SC/UPC 2 mm Jacketed Pigtails with Short Boot Connectors
COYTRM-4PK-LCA-SB	Pigtail Kit – Includes (4) LC/APC 2 mm Jacketed Pigtails with Short Boot Connectors
COYTRM-4PK-LCU-SB	Pigtail Kit – Includes (4) LC/UPC 2 mm Jacketed Pigtails with Short Boot Connectors
COYSP1X2SCA	COYOTE Pre-Connectorized Splitter - 1x2 SC/APC
COYSP1X4SCA	COYOTE Pre-Connectorized Splitter - 1x4 SC/APC
COYSP1X8SCA	COYOTE Pre-Connectorized Splitter - 1x8 SC/APC
COYSP1X16SCA	COYOTE Pre-Connectorized Splitter - 1x16 SC/APC



TERMINAL BRACKET FOR FIBER TERMINALS

The terminal bracket kit can be added to the universal organizer to install a Corning Evolv® Terminal or MST into the pedestal. This bracket can be installed on either the left or right side of the organizer allowing for flexibility in placement. The bracket features two legs that allow for a 2, 4, 6, 8 or 16-port Evolv terminal to slide easily onto the bracket. The terminal is then secured with a hold down strap. An MST can be attached to the top of the bracket using the hardware provided.

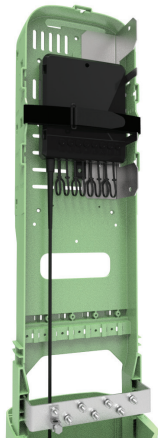

=



**Catalog Number:
COYPED810-TM**

COYOTE® Pedestal, 8" Terminal
Mounting Kit

COPPER APPLICATIONS

Routing Handles for Copper Splicing

The copper waterfall brackets, or routing handles, are used for copper applications when the splices need to be organized or stored in the pedestal. These brackets slide into the universal organizer and provide support for copper modules or splices.



=



**Catalog Number:
COYPED8-CWH**

COYOTE® Pedestal,
8" Routing Handle



COYOTE PEDESTAL ACCESSORIES

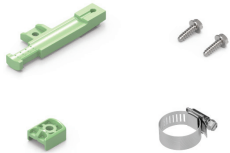

**Catalog Number:
COYPED-CRB**
Cable Restraint
Bracket Kit
Pack of 20



**Catalog Number:
COYPED-DRPCHNL**
Drop Channel Kit



**Catalog Number:
COYPED-BNDBRD**
Bonding Braid Kit
Pack of 20

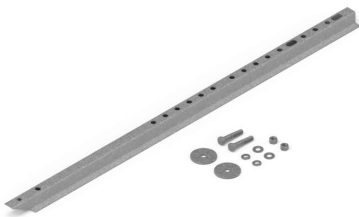

**Catalog Number:
COYPED-AS42**
42" Anchor Stake Kit



**Catalog Number:
COYPED-FBRTAB**
Fiber Retention Tab Kit
Pack of 50



**Catalog Number:
COYPED-FBRCLIP**
Fiber Cable
Management Clip Kit
Pack of 10



**Catalog Number:
COYPED-DRPGMT**
Drop Port Grommet
Pack of 20

Catalog Number	Description
COYPED-CRB	Cable Restraint Bracket Kit – Includes (20) Strength Member Brackets, (20) Strength Member Bracket Caps, (20) Hose Clamps, and (40) Hex Head Self-Tapping Screws
COYPED-DRPCHNL	Drop Channel Kit – Includes (1) Drop Channel and (1) Foam Plug
COYPED-BNDBRD	Bonding Braid Kit – Includes (20) Bonding Braids
COYPED-AS42	Anchor Stake Kit – Includes (1) 42" Anchor Stake and Mounting Hardware
COYPED-FBRTAB	Retention Tab Kit – Includes (50) Retention Tabs
COYPED-FBRCLIP	Fiber Cable Management Clip Kit – Includes (10) Fiber Routing Clips
COYPED-DRPGMT	Base Drop Grommet Kit – Includes (20) Base Drop Grommets



COYOTE 8" PEDESTAL REPLACEMENT KITS



**Catalog Number:
COYPED8-DOME**

Dome Replacement Kit

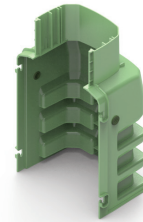

**Catalog Number:
COYPED8-BASE**

Base Replacement Kit



**Catalog Number:
COYPED8-GRDPLT**

Ground Plate Kit

Catalog Number	Description
COYPED8-DOME	8" Dome Replacement Kit
COYPED8-BASE	8" Base Replacement Kit
COYPED8-GRDPLT	Grounding Plate Kit for 8" Pedestal – Includes (1) Ground Plate Assembly and (1) Bonding Braid



GLOBAL HEADQUARTERS 660 BETA DRIVE CLEVELAND, OHIO 44143
+1 440 461 5200 INFO@PLP.COM PLP.COM

© 2024 Preformed Line Products Printed in U.S.A. CO-SS-1334 03.24.00