



DOC326.97.00090

Fish Farming Water Quality Test Kit

FF-2 (243001)

12/2022, Edition 2

User Manual

Section 1 General information	3
1.1 Safety information.....	3
1.2 Use of hazard information.....	3
1.3 Product overview.....	3
1.4 Product components.....	5
Section 2 Acidity	6
2.1 Test preparation.....	6
2.2 Test procedure—Acidity, methyl orange (100–400 mg/L CaCO ₃).....	6
2.3 Test procedure—Total (Phenolphthalein) Acidity (mg/L CaCO ₃).....	7
2.4 Replacement items.....	7
Section 3 Alkalinity	8
3.1 Test preparation.....	8
3.2 Test procedure—Alkalinity (mg/L as CaCO ₃).....	8
3.3 Replacement items.....	9
3.4 Optional items.....	10
Section 4 Ammonia	11
4.1 Test preparation.....	11
4.2 Test procedure—Ammonia nitrogen (0–3.0 mg/L NH ₃ -N).....	11
4.3 Replacement items.....	12
4.4 Optional items.....	12
4.5 Calculate the mg/L NH ₃	13
Section 5 Carbon dioxide	15
5.1 Test preparation.....	15
5.2 Test procedure—Carbon dioxide (mg/L CO ₂).....	15
5.3 Replacement items.....	16
5.4 Optional items.....	16
Section 6 Chloride	17
6.1 Test preparation.....	17
6.2 Test procedure—Chloride (mg/L Cl ⁻).....	17
6.3 Replacement items.....	18
6.4 Optional items.....	18
Section 7 Dissolved oxygen	19
7.1 Test preparation.....	19
7.2 Test procedure—Dissolved oxygen (0–10 mg/L O ₂).....	19
7.3 Solubility of oxygen in water.....	21
7.4 Replacement items.....	21
7.5 Optional items.....	22
Section 8 Hardness, Total	23
8.1 Test preparation.....	23
8.2 Test procedure—Hardness (mg/L CaCO ₃).....	23
8.3 Replacement items.....	24
8.4 Optional items.....	24
Section 9 Nitrite	25
9.1 Test preparation.....	25

Table of Contents

9.2 Test procedure—Nitrite-nitrogen LR (0–0.4 mg/L NO ₂ —N)	25
9.3 Replacement items	25
9.4 Optional items	26
Section 10 pH	27
10.1 Test preparation	27
10.2 Test procedure—pH (4–10 pH units)	27
10.3 Replacement items	28
10.4 Optional items	28
Section 11 Temperature	29
11.1 Replacement items	29
Section 12 Parts per million conversions	30

Section 1 General information

In no event will the manufacturer be liable for damages resulting from any improper use of product or failure to comply with the instructions in the manual. The manufacturer reserves the right to make changes in this manual and the products it describes at any time, without notice or obligation. Revised editions are found on the manufacturer's website.

1.1 Safety information

The manufacturer is not responsible for any damages due to misapplication or misuse of this product including, without limitation, direct, incidental and consequential damages, and disclaims such damages to the full extent permitted under applicable law. The user is solely responsible to identify critical application risks and install appropriate mechanisms to protect processes during a possible equipment malfunction.

Please read this entire manual before unpacking, setting up or operating this equipment. Pay attention to all danger and caution statements. Failure to do so could result in serious injury to the operator or damage to the equipment.

Make sure that the protection provided by this equipment is not impaired. Do not use or install this equipment in any manner other than that specified in this manual.

1.2 Use of hazard information

▲ DANGER

Indicates a potentially or imminently hazardous situation which, if not avoided, will result in death or serious injury.

▲ WARNING

Indicates a potentially or imminently hazardous situation which, if not avoided, could result in death or serious injury.

▲ CAUTION

Indicates a potentially hazardous situation that may result in minor or moderate injury.

NOTICE

Indicates a situation which, if not avoided, may cause damage to the instrument. Information that requires special emphasis.

1.3 Product overview

The Fish Farming Water Quality Test Kit includes the necessary items to measure important parameters in freshwater aquaculture. Refer to [Table 1](#). Control of the parameters helps to make a healthy environment for aquatic organisms.

Some measurement methods use reagents and color discs to make a visual determination of the parameter concentration. Refer to [Figure 1](#). Other measurement methods use reagents and titration procedures to measure the parameter concentration. Refer to the supplied documentation for use of the Digital Titrator.

Table 1 Test kit parameters

Parameter	Range	Method
Acidity	100–400 mg/L CaCO ₃	Titration
Alkalinity	100–400 mg/L CaCO ₃	Titration
Ammonia	0–3.0 NH ₃ –N	Color disc
Carbon dioxide	20–100 mg/L CO ₂	Titration
Chloride	10–40 mg/L Cl ⁻	Titration

Table 1 Test kit parameters (continued)

Parameter	Range	Method
Dissolved oxygen	0–20 mg/L O ₂	Titration
Hardness, total	100–400 mg/L CaCO ₃	Titration
Nitrite	0–0.4 mg/L NO ₂ –N	Color disc
pH	4–10 pH units	Color disc
Temperature	°F, °C	Thermometer

Figure 1 Color comparator box

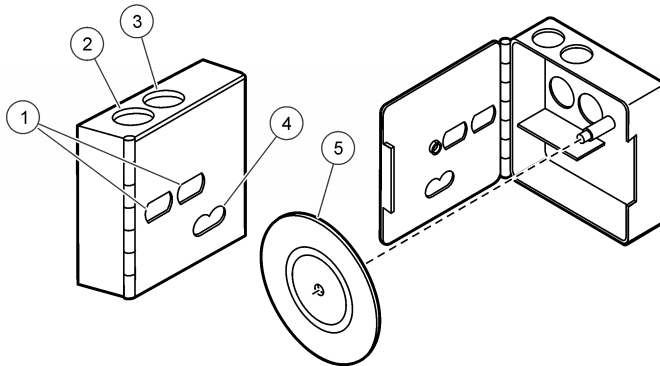

1 Windows for color matching	4 Scale window
2 Left opening for viewing tube	5 Color disc
3 Right opening for viewing tube	

1.4 Product components

Make sure that all components have been received. Refer to the list that follows. If any items are missing or damaged, contact the manufacturer or a sales representative immediately.

- Bottle, BOD, 60 mL
- Carrying case
- Clippers
- Color comparator box
- Color discs (3x)
- Color viewing tubes, plastic (2x)
- Digital Titrator
- User Manual for Digital Titrator
- Delivery tubes for Digital Titrator
- Flask, Erlenmeyer, 250 mL
- Graduated cylinder, 100 mL
- Thermometer, dual range, non-mercury
- Bromcresol Green-Methyl Red Powder Pillows
- Bromphenol Blue Indicator Powder Pillows
- Phenolphthalein Indicator Powder Pillows
- Diphenylcarbazone Reagent Powder Pillows
- Mercuric Nitrate Digital Titrator Cartridge, 0.2256 N
- Dissolved Oxygen 1 Powder Pillows
- Dissolved Oxygen 2 Powder Pillows
- Dissolved Oxygen 3 Powder Pillows (4x)
- Hardness 1 Buffer Solution
- ManVer 2 Hardness Indicator Powder Pillows
- EDTA Digital Titrator Cartridge, 0.800 M
- Mercuric Nitrate Digital Titrator Cartridge, 0.2256 N
- NitriVer3 Powder Pillows
- Nessler Reagent Solution
- Rochelle Salt Solution
- Sodium Thiosulfate Digital Titrator Cartridge, 0.0250 N
- Starch Indicator Solution
- Sodium Hydroxide Digital Titrator Cartridge, 0.3636 N
- Sodium Hydroxide Digital Titrator Cartridge, 1.600 N
- Sulfuric Acid Digital Titrator Cartridge, 1.600 N
- Wide-range pH Indicator Solution
- Water, deionized (2x)

Section 2 Acidity

2.1 Test preparation

⚠ CAUTION

Review the Safety Data Sheets (MSDS/SDS) for the chemicals that are used. Use the recommended personal protective equipment.

- Discard or clean the delivery tube immediately after use so the titrant does not dry and clog the tube. To clean, use a syringe or wash bottle to push water, then air through the tube.
- Keep the cap on the titration cartridge when not in use.
- Rinse the graduated cylinder and flask with deionized water after the test. Rinse the graduated cylinder with sample before the test.
- Pour and mix the sample carefully to prevent the loss of dissolved gases such as carbon dioxide.
- Acidity is the capacity of water to neutralize a strong base. The acidity of natural waters is usually very low. Carbonic acid is a weak acid that forms from dissolved carbon dioxide and is the primary acid in natural waters. Natural waters can also include organic acids such as tannic acids and strong mineral acids such as sulfuric acid from acid rain. The methyl orange procedure measures the acidity only from mineral acids. The bromphenol blue indicator is used as an alternative to the methyl orange indicator because bromphenol blue has a sharper color change at the endpoint.

2.2 Test procedure—Acidity, methyl orange (100–400 mg/L CaCO₃)

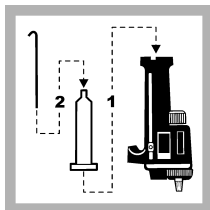

1. Attach a 1.600 N Sodium Hydroxide Titration Cartridge to the Digital Titrator. Insert a clean delivery tube into the cartridge.

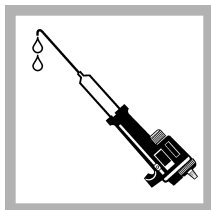

2. Hold the Digital Titrator with the cartridge tip up. Turn the delivery knob to eject air and a few drops of titrant. Reset the counter to zero and wipe the tip.

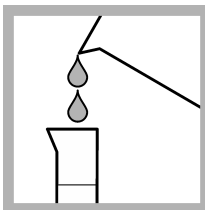

3. Fill a clean 100-mL graduated cylinder to the 100-mL mark with the sample.



4. Pour the sample into a clean, 250-mL Erlenmeyer flask.

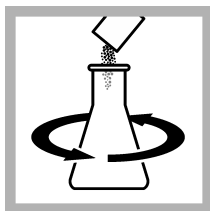

5. Add one Bromphenol Blue Powder Pillow. Swirl to mix. A yellow color develops if the sample contains mineral acidity. If the sample is green, the methyl orange acidity is zero.

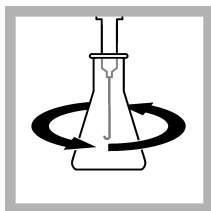

6. Put the end of the delivery tube fully into the solution. Swirl the flask.

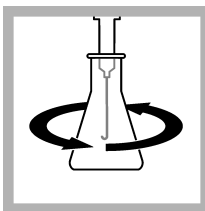

7. Turn the knob on the Digital Titrator to add titrant to the solution. Continue to swirl the flask. Add titrant until the color changes from yellow to pure green.

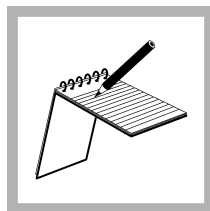

8. Record the number of digits on the counter. The number of digits is the concentration in mg/L.

2.3 Test procedure—Total (Phenolphthalein) Acidity (mg/L CaCO₃)

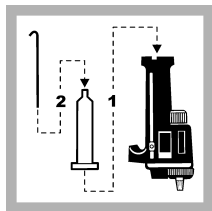

1. Attach a 1.600 N Sodium Hydroxide Titration Cartridge to the Digital Titrator. Insert a clean delivery tube into the cartridge.



2. Hold the Digital Titrator with the cartridge tip up. Turn the delivery knob to eject air and a few drops of titrant. Reset the counter to zero and wipe the tip.

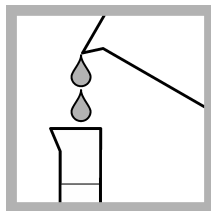

3. Fill a clean 100-mL graduated cylinder to the 100-mL mark with the sample.



4. Pour the sample into a clean, 250-mL Erlenmeyer flask.

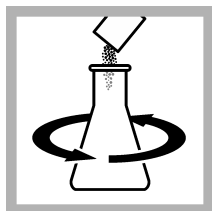

5. Add one Phenolphthalein Indicator Powder Pillow. Swirl to mix.

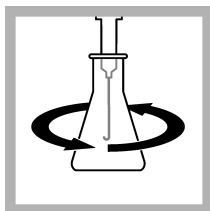

6. Put the end of the delivery tube fully into the solution. Swirl the flask.

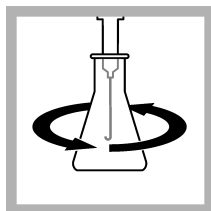

7. Turn the knob on the Digital Titrator to add titrant to the solution. Continue to swirl the flask. Add titrant until a pink color develops and stays for 30 seconds.

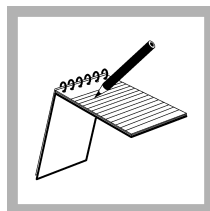

8. Record the number of digits on the counter. The number of digits is the concentration in mg/L.

2.4 Replacement items

Note: Product and Article numbers may vary for some selling regions. Contact the appropriate distributor or refer to the company website for contact information.

Description	Unit	Item no.
Bromphenol Blue Indicator Powder Pillows	100/pkg	1455099
Cylinder, graduated, polypropylene, 100 mL	each	108142
Delivery tube for Digital Titrator	5/pkg	1720500
Flask, Erlenmeyer, 250 mL	each	50546
Phenolphthalein Indicator Powder Pillows	100/pkg	94299
Sodium Hydroxide Digital Titrator Cartridge, 1.600 N	each	1437901
Water, deionized	100 mL	27242

Section 3 Alkalinity

3.1 Test preparation

⚠ CAUTION

Review the Safety Data Sheets (MSDS/SDS) for the chemicals that are used. Use the recommended personal protective equipment.

- Discard or clean the delivery tube immediately after use so the titrant does not dry and clog the tube. To clean, use a syringe or wash bottle to push water, then air through the tube.
- Keep the cap on the titration cartridge when not in use.
- Rinse the graduated cylinder and flask with deionized water after the test. Rinse the graduated cylinder with sample before the test.
- Alkalinity is the capacity of water to neutralize acids. Carbonates, bicarbonates and hydroxides are the primary sources of alkalinity in water. A high total alkalinity value makes water more resistant to pH changes.
- Alkalinity procedures use two endpoints. The first endpoint, phenolphthalein (pH 8.3), measures the total hydroxide and one half of the carbonate ions in the sample. The second endpoint, total, measures all carbonate, bicarbonate and hydroxide ions. The pH of the second endpoint can be different for different alkalinity levels and sample compositions. Refer to [Table 2](#).
- To help see the correct endpoint color, mix one pH Buffer Powder Pillow with the correct endpoint pH in 50 mL of deionized water, then add one Bromcresol Green-Methyl Red Powder Pillow. Compare the color of the buffer indicator solution to the sample during the titration.
- To verify the test accuracy, use a standard solution as the sample.

Table 2 Total alkalinity endpoint values

Sample composition	Endpoint
Alkalinity value approximately 30 mg/L	pH 4.9
Alkalinity value approximately 150 mg/L	pH 4.6
Alkalinity value approximately 500 mg/L	pH 4.3
Silicates or phosphates known to be in the sample	pH 4.5
Industrial wastes or complex mixture	pH 4.5

3.2 Test procedure—Alkalinity (mg/L as CaCO₃)

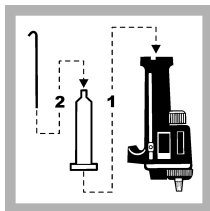

1. Attach a 1.600 N Sulfuric Acid Titration Cartridge to the Digital Titrator. Insert a clean delivery tube into the cartridge.



2. Hold the Digital Titrator with the cartridge tip up. Turn the delivery knob to eject air and a few drops of titrant. Reset the counter to zero and wipe the tip.

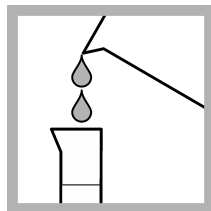

3. Fill a clean 100-mL graduated cylinder to the 100-mL mark with the sample.

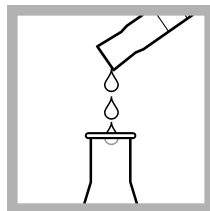

4. Pour the sample into a clean, 250-mL Erlenmeyer flask.

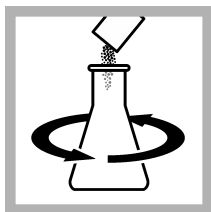

5. Add one Phenolphthalein Powder Pillow. Swirl to mix. A pink color develops. If a pink color does not develop, the phenolphthalein alkalinity is zero. Go to step 9.

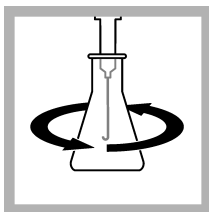

6. Put the end of the delivery tube fully into the solution. Swirl the flask.

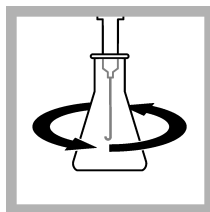

7. Turn the knob on the Digital Titrator to add titrant to the solution. Continue to swirl the flask. Add titrant until the color changes from pink to colorless.

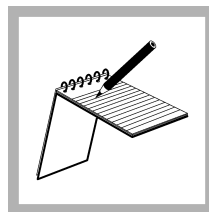

8. Record the number of digits on the counter. The number of digits is the concentration in mg/L.



9. Add one Bromocresol Green-Methyl Red Powder Pillow. Swirl to mix.

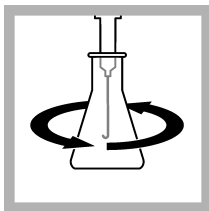

10. Put the end of the delivery tube fully into the solution. Swirl the flask.

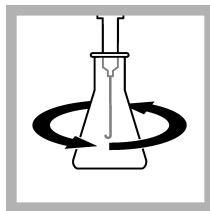

11. Turn the knob on the Digital Titrator to add titrant to the solution. Continue to swirl the flask. Add titrant until the color changes light greenish blue-gray (pH 5.1), a light violet-gray (pH 4.8) or a light pink (pH 4.5).

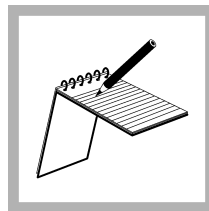

12. Record the number of digits on the counter. The number of digits is the concentration in mg/L.

3.3 Replacement items

Note: Product and Article numbers may vary for some selling regions. Contact the appropriate distributor or refer to the company website for contact information.

Description	Unit	Item no.
Bromocresol Green-Methyl Red Indicator Powder Pillows	100/pkg	94399
Cylinder, graduated, polypropylene, 100 mL	each	108142
Delivery tube for Digital Titrator	5/pkg	1720500
Flask, Erlenmeyer, 250 mL	each	50546
Phenolphthalein Indicator Powder Pillows	100/pkg	94299
Sulfuric Acid Digital Titrator Cartridge, 1.600 N	each	1438901
Water, deionized	100 mL	27242

3.4 Optional items

Description	Unit	Item no.
Alkalinity standard solution, 500 mg/L as CaCO ₃	1 L	2826253
Bromphenol Blue Indicator Powder Pillows	100/pkg	1455099
Buffer Powder Pillows, pH 4.50, 50 mL	25/pkg	89568
Buffer Powder Pillows, pH 8.30, 50 mL	25/pkg	89868
Bottle, wash, polyethylene, 500 mL	each	62011
Water, deionized	500 mL	27249

Section 4 Ammonia

4.1 Test preparation

⚠ CAUTION

Review the Safety Data Sheets (MSDS/SDS) for the chemicals that are used. Use the recommended personal protective equipment.

- Put the color disc on the center pin in the color comparator box (numbers to the front).
- Use sunlight or a lamp as a light source to find the color match with the color comparator box.
- Rinse the tubes with sample before the test. Rinse the tubes with deionized water after the test.
- If the color match is between two segments, use the value that is in the middle of the two segments.
- If the color disc becomes wet internally, pull apart the flat plastic sides to open the color disc. Remove the thin inner disc. Dry all parts with a soft cloth. Assemble when fully dry.
- To verify the test accuracy, use a standard solution as the sample.
- Fish metabolism and microbiological decay of organic matter cause ammonia to develop in fish waters. Refer to [Calculate the mg/L NH₃](#) on page 13 to determine how much of the ammonia is in the toxic, un-ionized form.
- The Rochelle Salt Solution removes interference from high water hardness.

4.2 Test procedure—Ammonia nitrogen (0–3.0 mg/L NH₃-N)

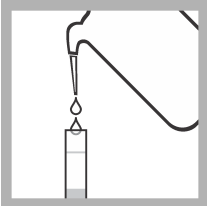

1. Fill a tube to the first line (5 mL) with deionized water.

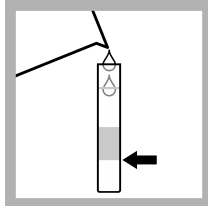

2. Fill a second tube to the first line (5 mL) with sample.

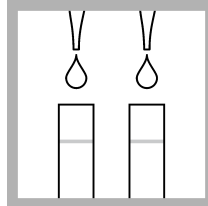

3. Add 1 drop of Rochelle Salt Solution to each tube. Swirl to mix.

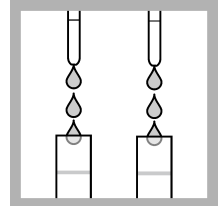

4. Add 3 drops of Nessler reagent to each tube.

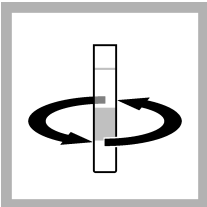

5. Swirl to mix. A yellow color develops. Put a stopper on each tube.



6. Wait 10 minutes.

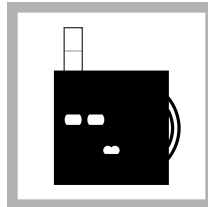

7. Put the first tube (with deionized water) into the left opening of the color comparator box.

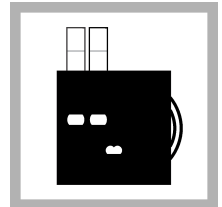

8. Put the second tube into the color comparator box.

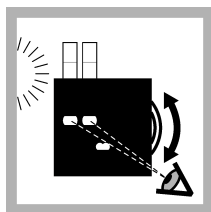

9. Hold the color comparator box in front of a light source. Turn the color disc to find the color match.

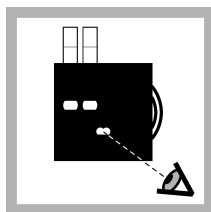

10. Read the result in mg/L in the scale window.

4.3 Replacement items

Note: Product and Article numbers may vary for some selling regions. Contact the appropriate distributor or refer to the company website for contact information.

Description	Unit	Item no.
Nessler reagent	100 mL MDB	2119432
Color disc, ammonia nitrogen, Nessler, 0–3.0 mg/L	each	9262600
Color comparator box	each	173200
Plastic viewing tubes, 18 mm, with caps	4/pkg	4660004
Rochelle salt solution	29 mL DB	172533
Water, deionized	100 mL	27242

4.4 Optional items

Description	Unit	Item no.
Nitrogen ammonia standard solution, 1.0 mg/L NH ₃ -N	500 mL	189149
Water, deionized	500 mL	27249

4.5 Calculate the mg/L NH₃

Ammonia in water is in the form of the ammonium ion (NH₄⁺) and un-ionized ammonia (NH₃). NH₃ is toxic to fish. [Table 3](#) shows that the percent of NH₃ increases as the pH and temperature increase. This test kit measures NH₄⁺ and NH₃ as ammonia nitrogen (NH₃-N).

To calculate the mg/L NH₃ in the sample, refer to [Table 3](#) and the equation that follows.

$$\text{mg/L NH}_3 = ((\text{mg/L NH}_3\text{-N} \times \text{percent NH}_3 \text{ from Table 3}) \div 100) \times 1.2$$

Example: The test result is 1.6 mg/L NH₃-N. The sample pH is 7.6 and the sample temperature is 16 °C. The mg/L NH₃ is $((1.6 \times 1.16) \div 100) \times 1.2 = 0.02 \text{ mg/L NH}_3$.

To calculate the mg/L NH₄⁺ in the sample, refer to [Table 3](#) and the equation that follows.

$$\text{mg/L NH}_4^+ = ((\text{mg/L NH}_3\text{-N} \times (100 - \text{percent NH}_3 \text{ from Table 3})) \div 100) \times 1.3$$

Example: The test result is 1.6 mg/L NH₃-N. The sample pH is 7.6 and the sample temperature is 16 °C. The mg/L NH₄⁺ is $((1.6 \times (100 - 1.16)) \div 100) \times 1.3 = 2.056 \text{ mg/L NH}_4^+$.

Table 3 Percent of NH₃ in water

pH	4 °C	6 °C	8 °C	10 °C	12 °C	14 °C	16 °C	18 °C	20 °C	22 °C	24 °C	26 °C	28 °C	30 °C	32 °C
7.0	0.11	0.13	0.16	0.18	0.22	0.25	0.29	0.34	0.39	0.46	0.52	0.60	0.69	0.80	0.91
7.2	0.18	0.21	0.25	0.29	0.34	0.40	0.46	0.54	0.62	0.82	0.83	0.96	1.10	1.26	1.44
7.4	0.29	0.34	0.40	0.46	0.54	0.63	0.73	0.85	0.98	1.14	1.31	1.50	1.73	1.98	2.26
7.6	0.45	0.53	0.63	0.73	0.86	1.00	1.16	1.34	1.55	1.79	2.06	2.36	2.71	3.10	3.53
7.8	0.72	0.84	0.99	1.16	1.35	1.57	1.82	2.11	2.44	2.81	3.22	3.70	4.23	4.82	5.48
8.0	1.13	1.33	1.56	1.82	2.12	2.47	2.86	3.30	3.81	4.38	5.02	5.74	6.54	7.43	8.42
8.2	1.79	2.10	2.45	2.86	3.32	3.85	4.45	5.14	5.90	6.76	7.72	8.80	9.98	11.29	12.72
8.4	2.80	3.28	3.83	4.45	5.17	5.97	6.88	7.90	9.04	10.31	11.71	13.26	14.95	16.78	18.77
8.6	4.37	5.10	5.93	6.88	7.95	9.14	10.48	11.97	13.61	15.41	17.37	19.50	21.78	24.22	26.80
8.8	6.75	7.85	9.09	10.48	12.04	13.76	15.66	17.73	19.98	22.41	25.00	27.74	30.62	33.62	36.72
9.0	10.30	11.90	13.68	15.65	17.82	20.18	22.73	25.46	28.36	31.40	34.56	37.83	41.16	44.53	47.91
9.2	15.39	17.63	20.08	22.73	25.58	28.61	31.80	35.12	38.55	42.04	45.57	49.09	52.58	55.99	59.31
9.4	22.38	25.33	28.47	31.80	35.26	38.84	42.49	46.18	49.85	53.48	57.02	60.45	63.73	66.85	69.79
9.6	31.36	34.96	38.38	42.49	46.33	50.16	53.94	57.62	61.17	64.56	67.77	70.78	73.58	76.17	78.55
9.8	42.00	46.00	50.00	53.94	57.78	61.47	64.99	68.31	71.40	74.28	76.92	79.33	81.53	83.51	85.30
10.0	53.44	57.45	61.31	64.98	68.44	71.66	74.63	77.35	79.83	82.07	84.08	85.88	87.49	88.92	90.19
10.2	64.53	68.15	71.52	74.63	77.46	80.03	82.34	84.41	86.25	87.88	89.33	90.60	91.73	92.71	93.58

Section 5 Carbon dioxide

5.1 Test preparation

⚠ CAUTION

Review the Safety Data Sheets (MSDS/SDS) for the chemicals that are used. Use the recommended personal protective equipment.

- Analyze samples immediately after collection.
- Pour and mix the sample carefully to prevent the loss of carbon dioxide.
- Discard or clean the delivery tube immediately after use so the titrant does not dry and clog the tube. To clean, use a syringe or wash bottle to push water, then air through the tube.
- Keep the cap on the titration cartridge when not in use.
- Rinse the graduated cylinder and flask with deionized water after the test. Rinse the graduated cylinder with sample before the test.
- Dissolved carbon dioxide is in surface waters at concentrations less than 10 mg/L. Ground water can have higher concentrations. Fish may tolerate high concentrations of carbon dioxide if dissolved oxygen concentrations are also high. Fish usually stay away from areas where the concentration of carbon dioxide is high. The relationship of carbon dioxide to fish respiration and photosynthesis causes daily fluctuations in the CO₂ concentration. The concentration usually increases during the night and decreases during the day. High concentrations of carbon dioxide may become toxic to fish when dissolved oxygen levels are very low.
- Carbonic acid is a weak acid that forms from dissolved carbon dioxide and is the primary acid in natural waters. Natural waters can also include organic acids such as tannic acids and strong mineral acids such as sulfuric acid from acid rain. If the sample contains sufficient quantities of acids other than carbonic acid, the test result will be higher than actual.
- To verify the test accuracy, use a standard solution as the sample.

5.2 Test procedure—Carbon dioxide (mg/L CO₂)

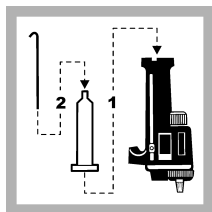

1. Attach a 0.3636 N Sodium Hydroxide Titration Cartridge to the Digital Titrator. Insert a clean delivery tube into the cartridge.

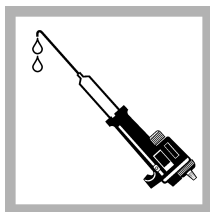

2. Hold the Digital Titrator with the cartridge tip up. Turn the delivery knob to eject air and a few drops of titrant. Reset the counter to zero and wipe the tip.

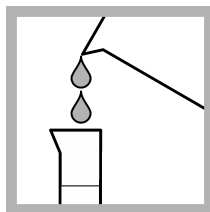

3. Fill a clean 100-mL graduated cylinder to the 100-mL mark with the sample.

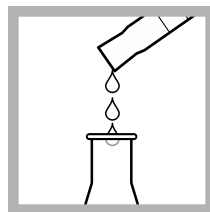

4. Pour the sample into a clean, 250-mL Erlenmeyer flask.



5. Add one Phenolphthalein Powder Pillow. Swirl to mix.

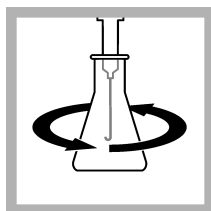

6. Put the end of the delivery tube fully into the solution. Swirl the flask.

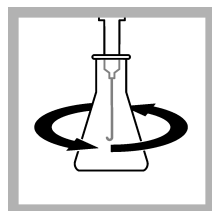

7. Turn the knob on the Digital Titrator to add titrant to the solution. Continue to swirl the flask. Add titrant until a pink color develops and stays for 30 seconds.

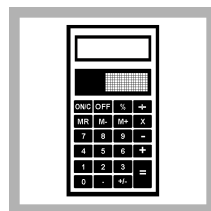

8. Record the number of digits on the counter. Divide the number by 5 to get the result in mg/L.

5.3 Replacement items

Note: Product and Article numbers may vary for some selling regions. Contact the appropriate distributor or refer to the company website for contact information.

Description	Unit	Item no.
Cylinder, graduated, polypropylene, 100 mL	each	108142
Delivery tube for Digital Titrator	5/pkg	1720500
Flask, Erlenmeyer, 250 mL	each	50546
Phenolphthalein Indicator Powder Pillows	100/pkg	94299
Sodium Hydroxide Digital Titrator Cartridge, 0.3636 N	each	1437801
Water, deionized	100 mL	27242

5.4 Optional items

Description	Unit	Item no.
Carbon dioxide standard solution, 100 mg/L as CO ₂ equivalent (KHP)	100 mL	226142
Bottle, wash, polyethylene, 500 mL	each	62011
Water, deionized	500 mL	27249

Section 6 Chloride

6.1 Test preparation

⚠ CAUTION

Review the Safety Data Sheets (MSDS/SDS) for the chemicals that are used. Use the recommended personal protective equipment.

- Discard or clean the delivery tube immediately after use so the titrant does not dry and clog the tube. To clean, use a syringe or wash bottle to push water, then air through the tube.
- Keep the cap on the titration cartridge when not in use.
- Rinse the graduated cylinder and flask with deionized water after the test. Rinse the graduated cylinder with sample before the test.
- Undissolved reagent does not have an effect on test accuracy.
- The chloride concentration in fish waters can be low or high. The concentration is usually higher near coastal regions. Measure chloride before and after salt is added to fish waters.
- If the chloride concentration is more than 100 mg/L, dilute the sample with deionized or chloride-free water. For example, pour 50 mL of sample in the graduated cylinder and add deionized water to the 100-mL mark. Use the diluted sample in the test procedure, then multiply the result by 2.
- To verify the test accuracy, use a standard solution as the sample.
- To record the test result as mg/L sodium chloride (NaCl), multiply the chloride result by 1.65.

6.2 Test procedure—Chloride (mg/L Cl⁻)

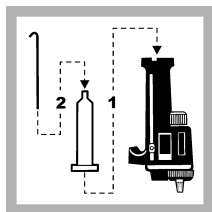

1. Attach a 0.2256 N Mercuric Nitrate Titration Cartridge to the Digital Titrator. Insert a clean delivery tube into the cartridge.



2. Hold the Digital Titrator with the cartridge tip up. Turn the delivery knob to eject air and a few drops of titrant. Reset the counter to zero and wipe the tip.

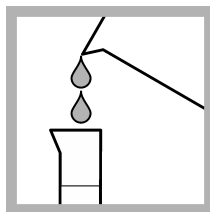

3. Fill a clean 100-mL graduated cylinder to the 100-mL mark with the sample.

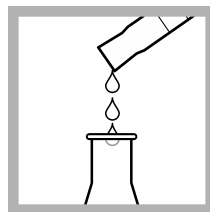

4. Pour the sample into a clean, 250-mL Erlenmeyer flask.

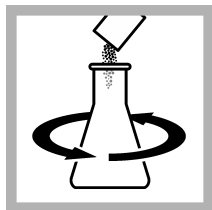

5. Add one Diphenylcarbazone Reagent Powder Pillow. Swirl to mix.

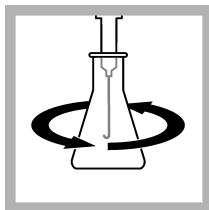

6. Put the end of the delivery tube fully into the solution. Swirl the flask.

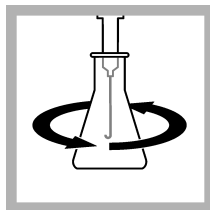

7. Turn the knob on the Digital Titrator to add titrant to the solution. Continue to swirl the flask. Add titrant until a pink color develops and stays for 30 seconds.

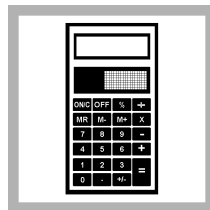

8. Record the number of digits on the counter. Divide the number by 10 to get the result in mg/L.

6.3 Replacement items

Note: Product and Article numbers may vary for some selling regions. Contact the appropriate distributor or refer to the company website for contact information.

Description	Unit	Item no.
Cylinder, graduated, polypropylene, 100 mL	each	108142
Delivery tube for Digital Titrator	5/pkg	1720500
Diphenylcarbazone Reagent Powder Pillows	100/pkg	83699
Flask, Erlenmeyer, 250 mL	each	50546
Mercuric Nitrate Digital Titrator Cartridge, 0.2256 N	each	1439301
Water, deionized	100 mL	27242

6.4 Optional items

Description	Unit	Item no.
Chloride standard solution, 100 mg/L Cl ⁻	1000 mL	2370853
Water, deionized	500 mL	27249

Section 7 Dissolved oxygen

7.1 Test preparation

⚠ CAUTION

Review the Safety Data Sheets (MSDS/SDS) for the chemicals that are used. Use the recommended personal protective equipment.

- To collect the sample from a faucet, let the sample overflow the bottle for 2 to 3 minutes. To collect the sample from a tank or pond, hold the bottle with the stopper in the water, then remove the stopper and let the bottle fill. Remove and drain the bottle, add the stopper and fill the bottle again. Collect the water samples at different locations and water depths for best results.
- Air bubbles cause incorrect results. To prevent air bubbles below the stopper, tilt the bottle and tap the stopper quickly on the bottle neck. Look below the stopper to make sure that there are no air bubbles.
- Discard or clean the delivery tube immediately after use so the titrant does not dry and clog the tube. To clean, use a syringe or wash bottle to push water, then air through the tube.
- Keep the cap on the titration cartridge when not in use.
- Rinse the graduated cylinder and bottle with deionized water after the test. Rinse the bottle with sample before the test.
- Keep the sodium thiosulfate away from direct sunlight.
- If the sample contains high concentrations of chloride (e.g., sea water) the floc that develops in the bottle does not fall. Wait 4 or 5 minutes after the floc develops, then continue the test.
- Measure the dissolved oxygen (DO) concentration frequently to help monitor the health of fish and other organisms. The primary source of oxygen in fish waters comes from photosynthesis by phytoplankton. The dissolved oxygen concentration changes with fluctuations in the temperature, sunlight, atmospheric pressure, salinity, plant life and water turbulence. Refer to [Table 4](#) on page 21.
- To verify the test accuracy, use a standard solution as the sample.
- For a more sensitive test, pour off 35 mL of the prepared sample into the 100-mL graduated cylinder, then titrate the 25-mL sample that stays in the 60-mL bottle. Divide the number of digits by 100 to get the test result in mg/L.
- As an alternative to the titration test procedure, use a portable dissolved oxygen meter with an electrode. A dissolved oxygen meter automatically adjusts the measurement for temperature, barometric pressure, altitude and salinity.

7.2 Test procedure—Dissolved oxygen (0–10 mg/L O₂)

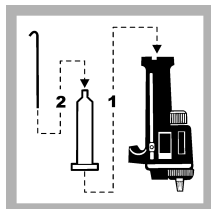

1. Attach a 0.0250 N Sodium Thiosulfate Titration Cartridge to the Digital Titrator. Insert a clean delivery tube into the cartridge.

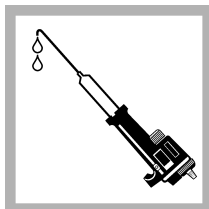

2. Hold the Digital Titrator with the cartridge tip up. Turn the delivery knob to eject air and a few drops of titrant. Reset the counter to zero and wipe the tip.

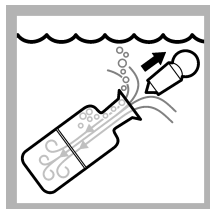

3. Hold the DO bottle with the stopper in the sample water. Remove the stopper and let the bottle fill to the top. Keep the bottle in the water.

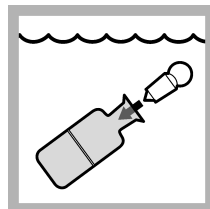

4. Tap the stopper quickly on the bottle neck. Remove the bottle from the water. Make sure that no air bubbles are trapped in the bottle.

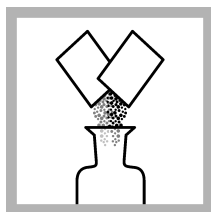

5. Add one Dissolved Oxygen 1 Powder Pillow and one Dissolved Oxygen 2 Powder Pillow.

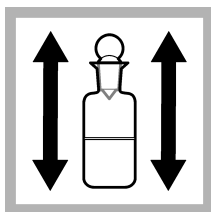

6. Immediately put the stopper on the bottle. Make sure that no air bubbles are below the stopper. Shake the bottle vigorously.

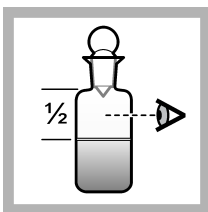

7. A brown-orange floc develops. The floc slowly falls. Wait until the top half of the bottle is clear.

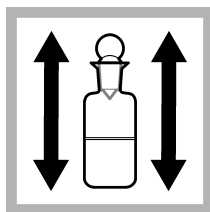

8. Shake the bottle again. Wait until the top half of the bottle is clear.

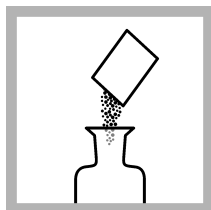

9. Remove the stopper. Add one Dissolved Oxygen 3 Powder Pillow.

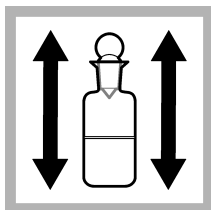

10. Immediately put the stopper on the bottle. Shake the bottle. The floc dissolves and a yellow color develops.

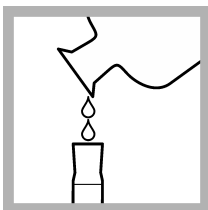

11. Pour the prepared sample into the graduated cylinder to the 50-mL mark.

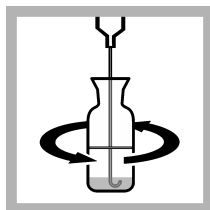

12. Put the end of the delivery tube fully into the solution. Swirl the bottle. Turn the knob on the Digital Titrator to add titrant to the solution. Continue to swirl the bottle. Add titrant until the color is pale yellow.

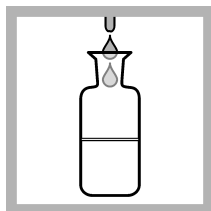

13. Add 2 drops of Starch Indicator Solution. Swirl to mix. A blue color develops.

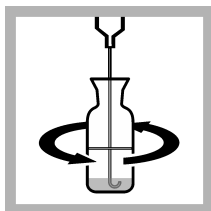

14. Continue the titration until the color changes from blue to colorless.

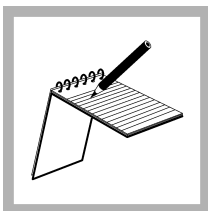

15. Record the number of digits on the counter. Divide the number by 40 to get the result in mg/L.

7.3 Solubility of oxygen in water

Table 4 shows the solubility of oxygen in water at different temperatures and barometric pressures (salinity = 0 ppt). For example, at 15 °C and 760 mm Hg, the solubility is 10.08 mg/L O₂.

Table 4 Oxygen solubility in water (mg/L) at different temperatures and pressures

T °C	Barometric pressure (mm Hg)							
	600	625	650	675	700	725	750	760
10	8.88	9.26	9.64	10.01	10.39	10.76	11.14	11.29
11	8.68	9.04	9.41	9.78	10.15	10.51	10.88	11.03
12	8.48	8.84	9.20	9.56	9.92	10.27	10.63	10.78
13	8.29	8.64	8.99	9.34	9.69	10.04	10.40	10.54
14	8.10	8.45	8.79	9.14	9.48	9.82	10.17	10.31
15	7.93	8.26	8.60	8.94	9.28	9.61	9.95	10.08
16	7.76	8.09	8.42	8.75	9.08	9.41	9.74	9.87
17	7.59	7.92	8.24	8.56	8.89	9.21	9.54	9.67
18	7.43	7.75	8.07	8.39	8.70	9.02	9.34	9.47
19	7.28	7.59	7.91	8.22	8.53	8.84	9.15	9.28
20	7.13	7.44	7.75	8.05	8.36	8.66	8.97	9.09
21	6.99	7.29	7.59	7.89	8.19	8.49	8.79	8.92
22	6.85	7.15	7.45	7.74	8.04	8.33	8.63	8.74
23	6.72	7.01	7.30	7.59	7.88	8.17	8.46	8.58
24	6.59	6.88	7.16	7.45	7.73	8.02	8.30	8.42
25	6.47	6.75	7.03	7.31	7.59	7.87	8.15	8.26
26	6.35	6.62	6.90	7.18	7.45	7.73	8.00	8.11
27	6.23	6.50	6.77	7.05	7.32	7.59	7.86	7.97
28	6.12	6.38	6.65	6.92	7.19	7.45	7.72	7.83
29	6.01	6.27	6.53	6.80	7.06	7.32	7.59	7.69
30	5.90	6.16	6.42	6.68	6.94	7.20	7.46	7.56

7.4 Replacement items

Note: Product and Article numbers may vary for some selling regions. Contact the appropriate distributor or refer to the company website for contact information.

Description	Unit	Item no.
Dissolved Oxygen 1 Reagent Powder Pillows, 60 mL	100/pkg	98199
Dissolved Oxygen 2 Reagent Powder Pillows, 60 mL	100/pkg	98299
Dissolved Oxygen 3 Reagent Powder Pillows	25/pkg	98768
Clippers	each	96800
Bottle, BOD, 60 mL, with stopper	each	190902
Cylinder, graduated, polypropylene, 100 mL	each	108142

7.4 Replacement items (continued)

Description	Unit	Item no.
Delivery tube for Digital Titrator	5/pkg	1720500
Sodium Thiosulfate Digital Titrator Cartridge, 0.0250 N, stabilized	each	2409301
Starch Indicator Solution	100 mL MDB	34932
Water, deionized	100 mL	27242

7.5 Optional items

Description	Unit	Item no.
Potassium iodide-iodate standard solution 0.00125 N (equivalent to 10 mg/L O ₂)	500 mL	40149
Bottle, wash, polyethylene, 500 mL	each	62011
Water, deionized	500 mL	27249

Section 8 Hardness, Total

8.1 Test preparation

⚠ CAUTION

Review the Safety Data Sheets (MSDS/SDS) for the chemicals that are used. Use the recommended personal protective equipment.

- Discard or clean the delivery tube immediately after use so the titrant does not dry and clog the tube. To clean, use a syringe or wash bottle to push water, then air through the tube.
- Keep the cap on the titration cartridge when not in use.
- Rinse the graduated cylinder and flask with deionized water after the test. Rinse the graduated cylinder with sample before the test.
- To verify the test accuracy, use a standard solution as the sample.
- If the sample color is blue after the indicator is added, the water is soft.
- Calcium and magnesium are the most abundant ions that contribute to hardness in natural waters. Other divalent ions also contribute to hardness, but the effects are usually negligible in natural waters. Treatment may be necessary when the total hardness values are low or significantly different from total alkalinity.

8.2 Test procedure—Hardness (mgL CaCO₃)

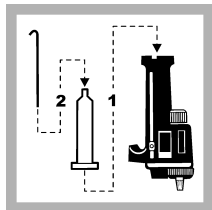

1. Attach a 0.800 M EDTA Titration Cartridge to the Digital Titrator. Insert a clean delivery tube into the cartridge.



2. Hold the Digital Titrator with the cartridge tip up. Turn the delivery knob to eject air and a few drops of titrant. Reset the counter to zero and wipe the tip.

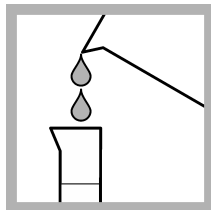

3. Fill a clean 100-mL graduated cylinder to the 100-mL mark with the sample.

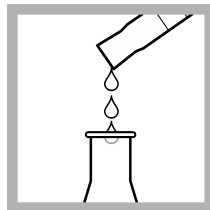

4. Pour the sample into a clean, 250-mL Erlenmeyer flask.

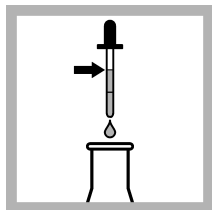

5. Use the 1-mL dropper two times to add 2 mL of the Hardness 1 Buffer Solution. Swirl to mix.

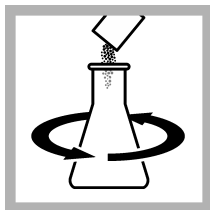

6. Add one ManVer 2 Reagent Powder Pillow. Swirl to mix.

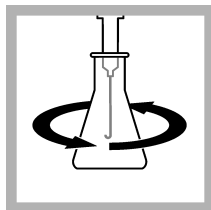

7. Put the end of the delivery tube fully into the solution. Swirl the flask.

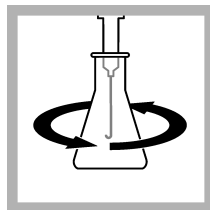

8. Turn the knob on the Digital Titrator to add titrant to the solution. Continue to swirl the flask. Add titrant until the color changes from pink to pure blue.

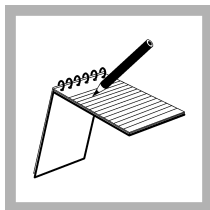

9. Record the number of digits on the counter. The number of digits is the concentration in mg/L.

8.3 Replacement items

Note: Product and Article numbers may vary for some selling regions. Contact the appropriate distributor or refer to the company website for contact information.

Description	Unit	Item no.
Cylinder, graduated, polypropylene, 100 mL	each	108142
Delivery tube for Digital Titrator	5/pkg	1720500
EDTA Digital Titrator Cartridge, 0.800 M	each	1439901
Flask, Erlenmeyer, 250 mL	each	50546
Hardness 1 Buffer Solution	100 mL MDB	42432
ManVer 2 Hardness Indicator Powder Pillows, 50 mL sample	100/pkg	85199
Water, deionized	100 mL	27242

8.4 Optional items

Description	Unit	Item no.
Standard solution, hardness, 340 mg/L (20 gpg) as CaCO ₃ and iron (2 mg/L)	500 mL	47949
Water, deionized	500 mL	27249

Section 9 Nitrite

9.1 Test preparation

⚠ CAUTION

Review the Safety Data Sheets (MSDS/SDS) for the chemicals that are used. Use the recommended personal protective equipment.

- Put the color disc on the center pin in the color comparator box (numbers to the front).
- Use sunlight or a lamp as a light source to find the color match with the color comparator box.
- Rinse the tubes with sample before the test. Rinse the tubes with deionized water after the test.
- If the color match is between two segments, use the value that is in the middle of the two segments.
- If the color disc becomes wet internally, pull apart the flat plastic sides to open the color disc. Remove the thin inner disc. Dry all parts with a soft cloth. Assemble when fully dry.
- Undissolved reagent does not have an effect on test accuracy.
- If the sample contains more than 0.5 mg/L nitrite-nitrogen, dilute the sample as follows. Use the dropper to add 1 mL of sample to each tube. Dilute the sample to the 5-mL mark with deionized water. Use the diluted sample in the test procedure and multiply the result by 5.
- To record the test result as mg/L NO_2^- , multiply the test result by 3.33.
- Nitrite-nitrogen develops during the biological decomposition of organic nitrogen compounds. Nitrites are quickly oxidized to nitrates and are not usually found in surface waters. Levels of nitrite more than the natural residual amounts can be acutely poisonous to fish.

9.2 Test procedure—Nitrite-nitrogen LR (0–0.4 mg/L NO_2^- -N)

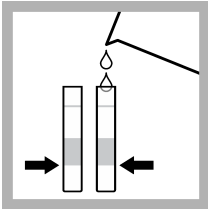

1. Fill two tubes to the first line (5 mL) with sample.

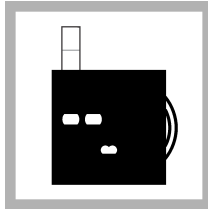

2. Put one tube into the left opening of the color comparator box.

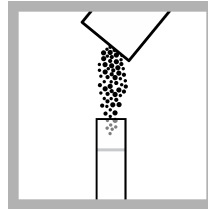

3. Add one NitriVer 3 Nitrite Reagent Powder Pillow to the second tube.

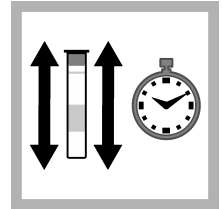

4. Put a cap on the tube. Shake for 1 minute. A pink color develops.



5. Wait 10 minutes. Read the result within 15 minutes.

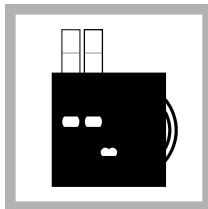

6. Put the second tube into the color comparator box.

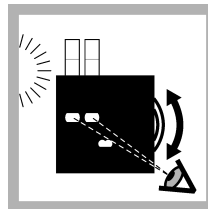

7. Hold the color comparator box in front of a light disc to find the color match.

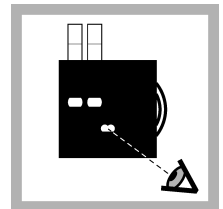

8. Read the result in mg/L in the scale window.

9.3 Replacement items

Note: Product and Article numbers may vary for some selling regions. Contact the appropriate distributor or refer to the company website for contact information.

Description	Unit	Item no.
NitriVer® 3 Nitrite Reagent Powder Pillows, 5 mL	100/pkg	1407899
Color disc, nitrite nitrogen, 0–0.4 mg/L	each	9262300
Color comparator box	each	173200
Plastic viewing tubes, 18 mm, with caps	4/pkg	4660004

9.4 Optional items

Description	Unit	Item no.
Caps for plastic viewing tubes (4660004)	4/pkg	4660014
Dropper, glass, 0.5- and 1.0-mL marks	5/pkg	1419705
Glass viewing tubes, 18 mm	6/pkg	173006
Stoppers for 18-mm glass tubes and AccuVac Ampuls	6/pkg	173106
Water, deionized	500 mL	27249

Section 10 pH

10.1 Test preparation

⚠ CAUTION

Review the Safety Data Sheets (MSDS/SDS) for the chemicals that are used. Use the recommended personal protective equipment.

- Put the color disc on the center pin in the color comparator box (numbers to the front).
- Use sunlight or a lamp as a light source to find the color match with the color comparator box.
- Rinse the tubes with sample before the test. Rinse the tubes with deionized water after the test.
- If the color match is between two segments, use the value that is in the middle of the two segments.
- If the color disc becomes wet internally, pull apart the flat plastic sides to open the color disc. Remove the thin inner disc. Dry all parts with a soft cloth. Assemble when fully dry.
- To verify the test accuracy, use a buffer solution as the sample.
- Chlorine can interfere with the test. To remove chlorine from the sample, add 1 drop of sodium thiosulfate solution to 5 mL of sample and mix. Use this dechlorinated sample in the test procedure. One drop of the sodium thiosulfate removes a maximum of 50 mg/L chlorine from the sample.
- The pH of water is a measure of the hydrogen ion concentration on a scale of 0 (very acidic) to 14 (very alkaline), with pH 7 being neutral. The pH of most natural waters ranges from pH 4 to pH 9. Dissolved carbon dioxide, carbonates, bicarbonates and acid rain cause changes in the pH. Phytoplankton and other aquatic plant life remove carbon dioxide from the water during photosynthesis, which causes the pH to increase during the day. To make an estimate of the pH cycle of a body of water, make pH measurements at different times of the day. The best pH values for fish production measured at sunrise are approximately 6.5 to 9. The acid and alkaline death points for most fish are approximately pH 4 and pH 11.

10.2 Test procedure—pH (4–10 pH units)

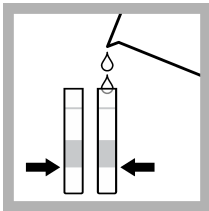

1. Fill two tubes to the first line (5 mL) with sample.

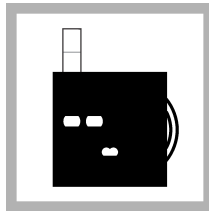

2. Put one tube into the left opening of the color comparator box.

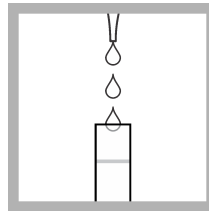

3. Add 6 drops of wide range pH indicator solution to the second tube.

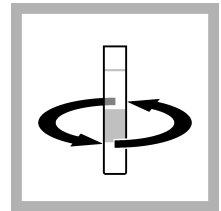

4. Swirl to mix.

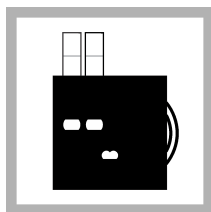

5. Put the second tube into the color comparator box.

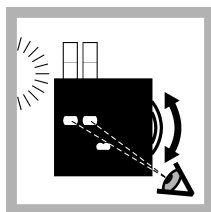

6. Hold the color comparator box in front of a light source. Turn the color disc to find the color match.

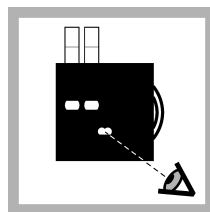

7. Read the result in pH units in the scale window.

10.3 Replacement items

Note: Product and Article numbers may vary for some selling regions. Contact the appropriate distributor or refer to the company website for contact information.

Description	Unit	Item no.
Wide range pH indicator solution	100 mL MDB	2329332
Color disc, pH, wide range	each	990100
Color comparator box	each	173200
Plastic viewing tubes, 18 mm, with caps	4/pkg	4660004

10.4 Optional items

Description	Unit	Item no.
pH 7.0 buffer solution, colorless	500 mL	1222249
Caps for plastic viewing tubes (4660004)	4/pkg	4660014
Water, deionized	500 mL	27249
Glass viewing tubes, 18 mm	6/pkg	173006
Sodium thiosulfate, 0.1 N	100 mL MDB	32332
Stoppers for 18-mm glass tubes and AccuVac Ampuls	6/pkg	173106

Section 11 Temperature

Temperature has a large effect on the chemical and biological systems in water. Lower temperatures decrease the growth rates of fish and fish food organisms but increase the solubility of oxygen. Higher temperatures increase the use of dissolved oxygen by aquatic life but decrease the solubility of oxygen.

Different temperature zones occur in natural waters because the density of water changes with temperature. Fish can adjust to different temperature zones if the temperature changes slowly. Sudden changes in water temperature can kill fish. Make sure to record the depth where the temperature is measured.

11.1 Replacement items

Note: Product and Article numbers may vary for some selling regions. Contact the appropriate distributor or refer to the company website for contact information.

Description	Unit	Item no.
Thermometer, dual range, -10 to 110 °C, 0 to 220 °F, non-mercury	each	2676400

Section 12 Parts per million conversions

Refer to [Table 5](#) to find the conversions from parts per million (ppm) to proportion and percent. In water, ppm (mg/kg) is equivalent to mg/L because 1 liter of water weighs 1 kg.

Table 5 Parts per million conversions

Parts per million	Proportion	Percent (%)
0.1	1:10,000,000	0.00001
0.5	1:2,000,000	0.00005
1.0	1:1,000,000	0.0001
2.0	1:500,000	0.0002
3.0	1:333,333	0.0003
4.0	1:250,000	0.0004
5.0	1:200,000	0.0005
10.0	1:100,000	0.001
15.0	1:66,667	0.0015
20.0	1:50,000	0.002
25.0	1:40,000	0.0025
50.0	1:20,000	0.005
100.0	1:10,000	0.01
150.0	1:6,667	0.015
200.0	1:5,000	0.02
250.0	1:4,000	0.025
500.0	1:2,000	0.05
1,000.0	1:1000	0.1
5,000.0	1:200	0.5
10,000.0	1:100	1.0
50,000.0	1:20	5.0



HACH COMPANY World Headquarters

P.O. Box 389, Loveland, CO 80539-0389 U.S.A.
Tel. (970) 669-3050
(800) 227-4224 (U.S.A. only)
Fax (970) 669-2932
orders@hach.com
www.hach.com

HACH LANGE GMBH

Willstätterstraße 11
D-40549 Düsseldorf, Germany
Tel. +49 (0) 2 11 52 88-320
Fax +49 (0) 2 11 52 88-210
info-de@hach.com
www.de.hach.com

HACH LANGE Sàrl

6, route de Compois
1222 Vézenaz
SWITZERLAND
Tel. +41 22 594 6400
Fax +41 22 594 6499