

DR/2000 SPECTROPHOTOMETER INSTRUMENT MANUAL



**PLACE CALIBRATION
DATA LABEL HERE**



TABLE OF CONTENTS

Section	Page
	Safety Precautions v
	Certification v
	Specifications v
1	General Description 1
	1.1 Instrument Description 1
	1.2 Accessories 1
2	Preparation For Use 2
	2.1 Unpacking 2
	2.2 Supplying Operating Power 2
	2.2.1 Battery Eliminator/Charger 2
	2.2.2 Battery Installation 2
	2.3 Recorder Connection 2
	2.4 RS232 Connection 3
	2.5 Pour-Thru Cell Setup 3
	2.6 Sample Cell Adapter Installation 3
3	Operation 4
	3.1 Description of Operating Controls 4
	3.2 Testing With Factory-Programmed Methods 6
	3.2.1 Spectrophotometer Setup 7
	3.2.2 Sample Preparation 7
	3.2.3 Zeroing the Spectrophotometer 8
	3.2.4 Taking the Reading 8
	3.3 Testing With Operator-Programmed Calibrations 9
	3.3.1 Entering A Calibration 9
	3.3.2 Completing the Test 18
	3.3.3. Alternate Method for Entering A Calibration 18
	3.4 Reviewing and Changing Operator-Programmed Methods 18
	3.5 Re-Using Operator-Stored Method Number 19
	3.6 Erasing All Operator-Stored Methods 19
	3.7 Configure Programming 19
	3.7.1 Language Selection 19
	3.7.2 Choosing the Lamp Mode 19
	3.7.3 Choosing Printer Output Frequency 20
	3.7.4 Tone Generator 20
	3.8 Using the Pour-Thru Cell 20
	3.9 Using the AccuVac Vial Adapter 21
	3.10 Using the COD Vial Adapter 21
	3.11 Using the 1-cm Cell Adapter 21
	3.12 Using the 13-mm Test Tube Adapter 22
	3.13 Using a Printer 22
	3.14 Using a Recorder 22
4	Maintenance 24
	4.1 Cleaning 24
	4.1.1 Spectrophotometer 24
	4.1.2 Sample Cells 24
	4.1.3 Pour-Thru Sample Cell 24
	4.2 Replacement Instructions 24
	4.2.1 Battery Replacement 24
	4.2.2 Lamp Replacement 24
	4.3 Wavelength Accuracy Check 25

TABLE OF CONTENTS (continued)

Section		Page
5	Troubleshooting	26
	5.1 Introduction	26
	5.2 Error Messages	26
	5.2.1 INCORRECT # Display	26
	5.2.2 OVER-RANGE Display	26
	5.2.3 LOW BATTERY Display	26
	5.2.4 LAMP OUT Display	26
	5.2.5 MEMORY ERROR Display	27
	5.2.6 Restoring Factory Settings	27
6	Replacement Parts and Accessories	28
7	Repair Service	29
8	Warranty	30

ILLUSTRATIONS

Figure		Page
1	DR/2000 Spectrophotometer with Accessories	1
2	Battery Installation	2
3	Recorder Plug Connection	3
4	RS-232 Plug Connection	3
5	Pour-Thru Cell Assembly	3
6	Operating Controls, Indicators and Connectors	5
7	Selecting Wavelength	7
8	Adding Pillow of Reagent	8
9	Placing Blank Solution in Cell Holder	8
10	Placing Prepared Sample in Cell Holder	9
11	Sample User-Entered Calibrations Worksheet	17
12	Installing Pour-Thru Cell	20
13	Installing AccuVac Vial Adapter	21
14	Installing COD Vial Adapter	21
15	Installing 1-cm Cell Adapter	22
16	Installing Test Tube Adapter	22
17	Sample Printer Format	22
18	Lamp Replacement	24

SAFETY PRECAUTIONS

Before attempting to unpack, set up or operate this instrument, please read this entire manual. Pay particular attention to all warnings, cautions and notes. Failure to do so could result in serious injury to the operator or damage to the equipment.

Use of Warnings, Cautions and Notes

Warnings, cautions and notes used in this manual have the following significance:

WARNING

Failure to observe this information can result in personal injury or loss of life.

CAUTION

Failure to observe this information can result in damage to equipment.

NOTE

Information that requires special emphasis.

Precautionary Labels

Please pay particular attention to labels and tags attached to the instrument. Personal injury or damage to the instrument could occur if not observed.

CERTIFICATION

Hach Company certifies this instrument was tested thoroughly, inspected and found to meet its published specifications when it was shipped from the factory.

INSTRUMENT SPECIFICATIONS

(Specifications subject to change without notice)

Wavelength Range 400–900 nm

Bandwidth 12 ± 2 nm @ 600 nm

Wavelength Accuracy ± 2 nm from 400-700 nm;
± 3 nm from 700-900 nm

Wavelength Resolution 1 nm

Monochromator Design Littrow Prism, Aspheric Optics

Wavelength Selection Manual

Wavelength Readout 3-digit LCD, 0.5-cm Character Height

Photometric Linearity ± 0.002 A (0-1 A, 500 nm—constant on mode)

Photometric Reproducibility ± 0.005 A (0-1 A—constant on mode)

Source Lamp Gas-filled Tungsten

Detector Silicon Photodiode, UV enhanced

Data Readout 4-digit LCD, 1.5-cm Character Height

Message Display 16 character LCD dot-matrix, 0.6-cm Character Height

Operation Modes Momentary, Constant-On

Readout Modes Transmittance, Absorbance, Concentration

Decimal Location Hach Program—Automatic, User Program—Selected

Readout Languages Selectable by menu: English, French, Italian, Spanish, Portuguese, German, Dutch, Norwegian, Swedish, Danish, Finnish, Turkish, Greek, Japanese

External Outputs RS-232 Serial, (printer optional) 0-1 V Analog

Line Power Selectable 110/220 V 50/60 Hz

Battery Power (optional) Rechargeable 8 V sealed or 6-battery “D” Cell Pack

Dimensions 22 x 24 x 11 cm (8.75 x 9.5 x 4.375 in)

Weight 2 kg (4.4 lb)

Dynamic Range 0-2 A (100:1)

Stray Light < 1.00% at 400 nm

Bulb Life 2,000 hours, >1,000,000 measurement cycles

Battery Life 1000 measurement cycles (rechargeable). Charger included.

Battery Weight (optional rechargeable) 1.7 kg (3.75 lb) (rechargeable)

Temperature Range 0-40°C operating range

SECTION 1 GENERAL DESCRIPTION

1.1 Instrument Description

The Hach Model DR/2000 Spectrophotometer shown in Figure 1 is a microprocessor-controlled, single-beam instrument suitable for the laboratory or the field. The current instrument is precalibrated for over 120 different colorimetric measurements and has RAM capacity sufficient for up to 50 more operator-generated calibrations. Additional memory for future Hach updates has been incorporated.

Test results can be displayed in percent transmittance, absorbance or concentration of the appropriate units of measure. The LCD dot-matrix digital display offers automatic ranging in the pre-programmed parameters, operator-selected languages (a choice of 14), full prompting during testing and error messages for procedural or instrument troubleshooting. A built-in timer helps the operator observe specific reaction times called for in the test procedures. RS-232 interface capability allows an external printer to be driven by the spectrophotometer, and a 0 to 1-volt analog output is provided for a recorder.

The spectrophotometer can operate on battery power or ac line power using the battery eliminator/charger unit supplied with the accessories. The battery holder supplied holds six D-size dry cells that will power the instrument for

approximately 100 tests. An optional rechargeable battery is available, and it can be recharged with the battery eliminator/charger supplied with the instrument. The eliminator/charger can not be used to charge rechargeable D-size batteries, however.

1.2 Accessories

Accessories supplied with the DR/2000 Spectrophotometer include:

- Matched Sample Cells (2)
- Battery Eliminator/Charger
- Battery Holder (for 6 D-size batteries)
- AccuVac Vial Adapter
- AccuVac Zeroing Vial
- Spare Lamp
- Manual Set
- COD Vial Adapter
- 13-mm Test Tube Adapter

In addition to these accessories, several optional accessories are available from Hach Company. Refer to Section 6.

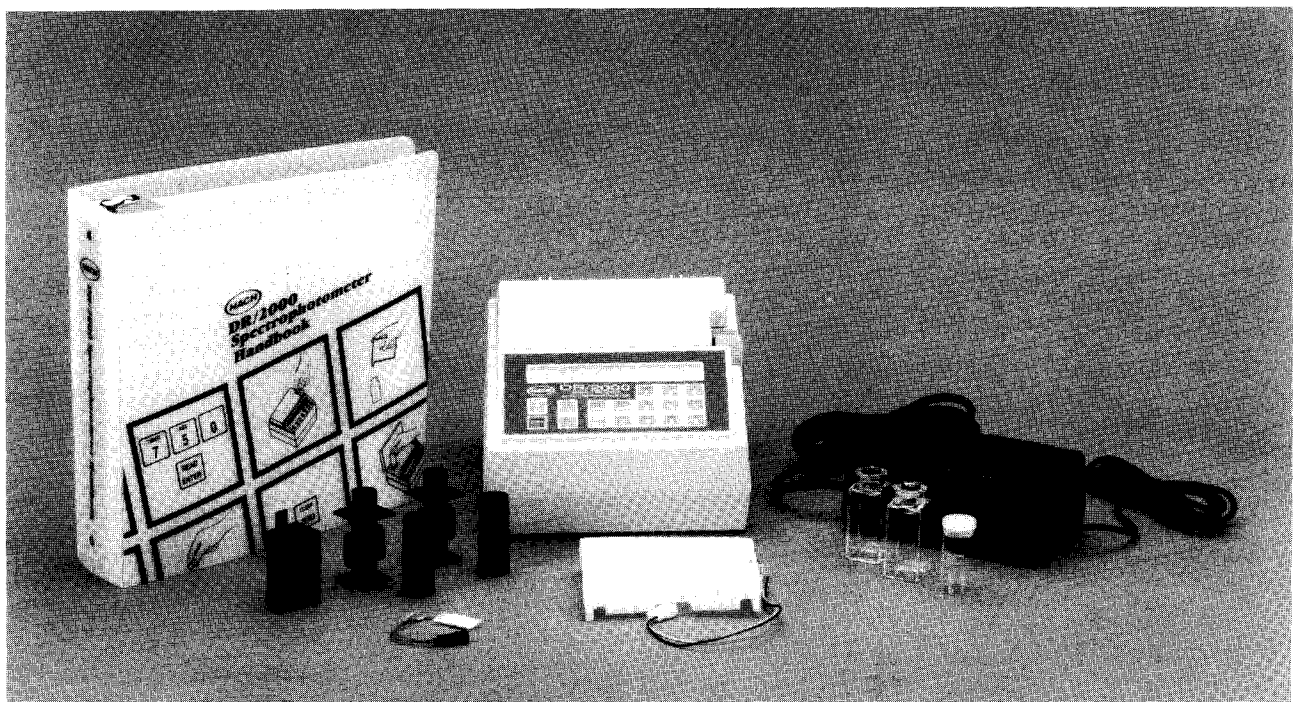

Figure 1

DR/2000 Spectrophotometer With Accessories

SECTION 2 PREPARATION FOR USE

2.1 Unpacking

Remove the instrument and accessories from the shipping container and inspect each item for any damage that may have occurred because of rough handling or extreme weather conditions during shipment. Verify that the items listed in paragraph 1.2 are included. If any items are missing or damaged, please contact Hach Customer Service, Loveland, Colorado for instructions. The toll-free number is 800-227-4224.

2.2 Supplying Operating Power

2.2.1 Battery Eliminator/Charger

If line power is to be used, connect the battery eliminator/charger cable plug to the POWER jack on the back of the instrument. When the battery eliminator/charger is connected and operating, the instrument will operate on line power only and the battery can not power the instrument. If the optional rechargeable battery is installed, the instrument can be operated and the battery charged in this configuration. To operate on D-cell battery power, the eliminator/charger must be disconnected from the instrument. If the eliminator/charger is connected to the instrument but not plugged into a line power receptacle, the instrument will not operate.

CAUTION

The battery eliminator/charger unit is switchable for 115V or 230 V operation. Be sure the voltage selector switch on the underside of the battery eliminator/charger is set to the appropriate position before plugging in the unit. Improper setting can result in serious damage to the instrument and the eliminator/charger when power is applied.

2.2.2 Battery Installation

The battery compartment is accessible from the underside of the instrument. Lay the instrument upside down on a padded surface and install batteries as follows:

1. Remove the compartment cover as shown in Figure 2.
2. *D-Cells*—Install six D-cells in the battery holder as shown in the battery holder detail in Figure 2. Polarity marks on the holder also show how the cells should be installed for the proper configuration. Place the holder into the battery compartment.

WARNING

Use care when installing the D-cells in the battery holder to be sure that the proper

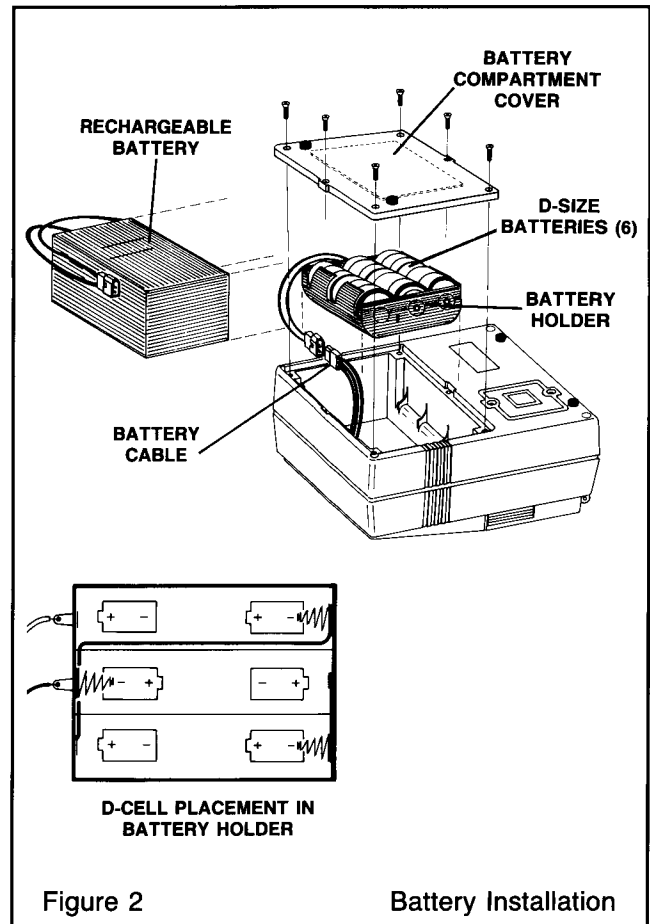

Figure 2

Battery Installation

polarities are observed. Improper installation could cause damage to the instrument or injury to the operator.

3. Connect the battery cable from the instrument to the battery holder cable connector or the rechargeable battery cable connector.
4. *Rechargeable Battery*—Place the battery into the battery compartment as shown in the drawing and route the wires along the side of the battery.
5. Replace the battery compartment cover and return the instrument to the upright position.
6. If the rechargeable lead-acid battery is being used, top-charge the battery for 18 to 20 hours before placing it in operation

2.3 Recorder Connection

The recorder output jack (REC) on the back panel takes a sub-miniature phone plug wired as shown in Figure 3. A suitable plug is listed in the list of optional accessories in Section 6. Hach recommends a twisted-pair, shielded cable be used for the recorder input cable and the load impedance be greater than 10k ohms. The shield connection may be optional in some cases.

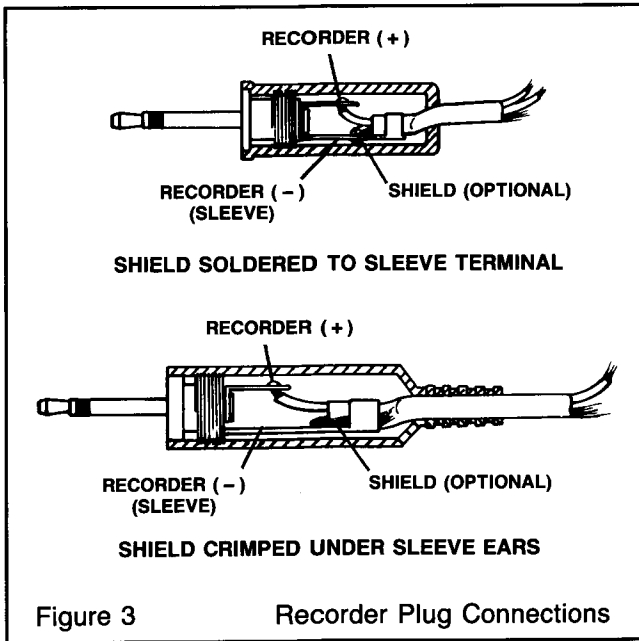

2.4 RS-232 Connection

The RS-232 jack on the back panel mates with a three-conductor, 1/4" phone plug wired as shown in Figure 4. A suitable plug is listed in the List of Accessories in Section 6. The RS-232C interface output is an eight-bit data word plus one stop bit and no parity with a baud rate of 1200. It can be used to link to either a serial printer or a serial input port on a computer. If the RS-232 feature is to be used for a serial printer, a printer cable assembly terminated with a standard 25-pin D connector is available as an optional accessory. Refer to Section 6. With the use of a serial-to-parallel converter, the data string transmitted from the DR/2000 Spectrophotometer can be printed on any Epson-

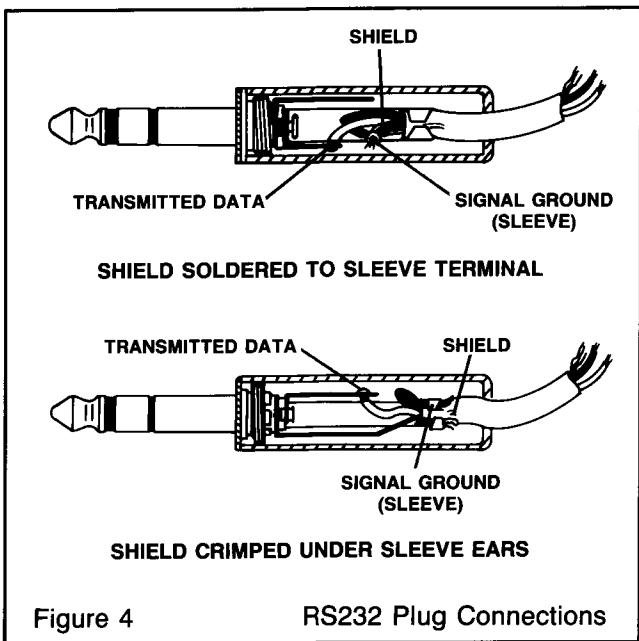

compatible parallel printer of the type normally used with IBM-compatible applications.

Data is transmitted to the printer as a 26-character string plus the line feed and carriage return.

2.5 Pour-Thru Cell Setup

The optional Pour-Thru Cell must be assembled before use. Figure 5 illustrates the assembled unit.

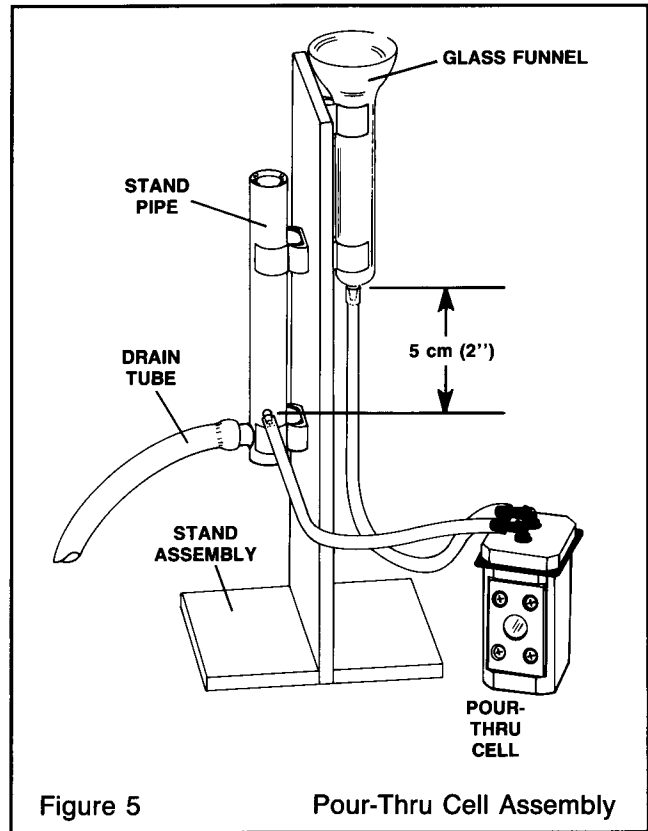

The kit includes:

- Pour-Thru Cell
- Stand Assembly
- Glass Funnel
- Stand Pipe
- 1/8" ID plastic tubing (6 ft)
- 1/4" ID rubber tubing (12 ft)
- Instruction Sheet

CAUTION

Do not use the pour-thru cell in tests that call for the use of organic solvents such as toluene, chloroform, trichloroethane or cyclohexanone.

2.6 Sample Cell Adapter Installation

The light path is oriented on a course from right to left as you view from the front of the instrument. When placing one of the adapters into the cell holder, have the light path ports in the adapters with the same orientation. All of the adapters can be rotated 180 degrees with no effect on the optics. For a list of the available adapters, refer to Replacement Parts and Accessories in Section 6.

SECTION 3 OPERATION

3.1 Description of Operating Controls

Figure 6 shows the spectrophotometer controls, indicators and connections. Their functional descriptions are given in Table 1.

Table 1. Operating Controls, Indicators and Connections

Item No.	Name	Description
1	Cell Compartment Cover	Light shield for sample cell compartment. Contains list of stored program numbers on underside
2	Wavelength Control	Used to select wavelength in nanometers appropriate for test parameter
3	Display	LCD display window divided into three function areas: wavelength, numeric output and alphanumeric message. Indicates wavelength, prompts and gives measurement results in operational modes. Displays menu options when scrolling through menu with arrow keys. Provides error messages when invalid entries are made.
4	TIMER/7 key	Initiates timer function when used with shift key. Has numeric key function when shift key is not used.
5	-/8 key	Minus sign for entering negative superscript sign. Used with shift key. Has numeric key function when shift key is not used.
6	+/9 key	Plus sign for entering positive superscript sign. Used with shift key. Has numeric key function when shift key is not used.
7	CONC/6 key	Initiates concentration readout mode when used with shift key. Has numeric key function when shift key is not used.
8	ABS/5 key	Initiates absorbance readout mode when used with shift key. Has numeric key function when shift key is not used.
9	%T/4 key	Initiates percent transmittance readout mode when used with shift key. Has numeric key function when shift key is not used.
10	PROG/3 key	Used to initiate operator-stored calibrations when used with shift key and METH key. Also used with SHIFT and TIMER keys to initiate timer. Has numeric key function when shift key is not used.
11	EDIT/2 key	Used to review or alter operator-stored calibrations when used with the shift key. Has numeric key function when shift key is not used.
12	BATT/1 key	Used to check condition of battery when used with shift key. Current battery voltage and battery-life bar graph will be displayed. Has numeric key function when shift key is not used.
13	CLEAR/ZERO key	Used with the shift key to correct a wrong keystroke in the display before the value has been entered. Without shift key, used to zero the instrument with the blank solution in the cell holder prior to measuring the test sample.
14	./0 key	Decimal point used in Lamp Out diagnostics only. Without shift key, has numeric function.
15	CONFIG/METH key	Used with shift key to call up configure menu for selection of language and momentary or constant-on operation. Without shift key, used to call up method menu. Also used to exit a method and return to method prompt without shift key.
16	READ/ENTER key	Initializes function selections that have been keyed in or scrolled to. Can be used to over-ride a programmed wavelength to substitute an alternate.

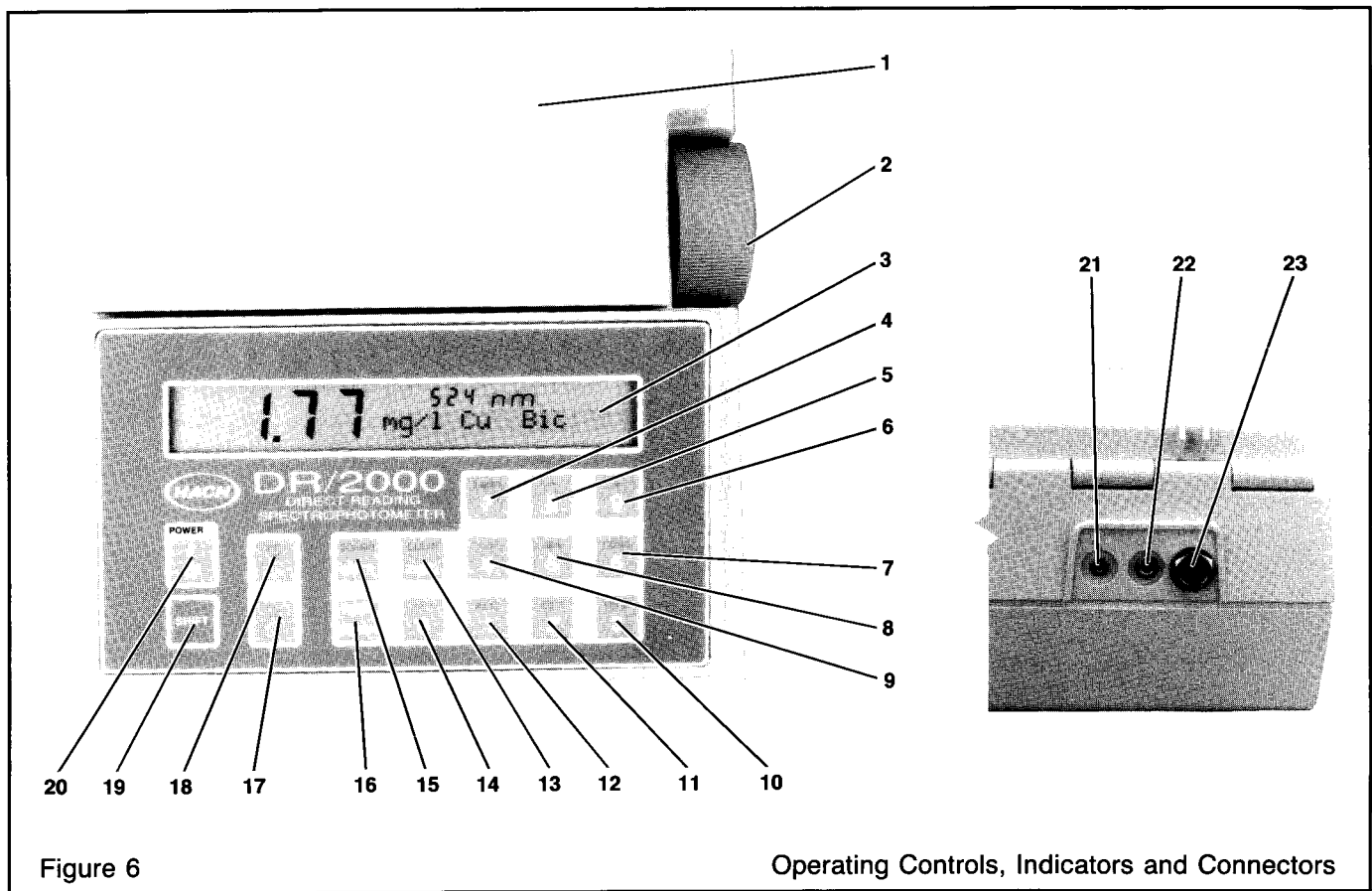

Figure 6







Operating Controls, Indicators and Connectors

Item No.	Name	Description
17	Right Arrow/Down Arrow key	Right arrow key used to move the cursor to the right (one digit at a time) when changing a displayed value. Down arrow used to scroll in forward direction through selected menu. Shift key is not used for these functions.
18	Left Arrow/Up Arrow key	Left arrow used to move the cursor to the left (one digit at a time) for editing a displayed value. Up arrow used to scroll in backward direction through selected menu. Shift key is not used for these functions. Left arrow used with shift key to erase and backspace to allow wrongly keyed characters to be corrected.
19	SHIFT key	Used to select the top (blue) function of the dual-function keys. Also used to toggle the tone generator on and off. (See 3.7.4.) When on, audible beep will sound each time a key is pressed, indicating the keystroke has been accepted by the instrument.
20	POWER key	Toggles operating power on and off. If the instrument is to be operated in the Constant-On mode, allow 5 minutes for warm-up.
21	REC Jack	Connection for 0 to 1 V analog output.
22	POWER Jack	Connection for battery eliminator/charger unit.
23	RS-232 Jack	Serial port for printer or computer interface.

3.2 Testing With Factory-Programmed Methods

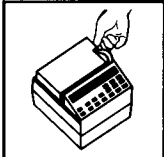
The graphic presentation here is a summarized example that is typical of most preprogrammed test methods. A more detailed discussion follows. Once

the operator is familiar with DR/2000 Spectrophotometer operation, this summary can be used as a quick reference source when needed.

Step	Action/Keystroke(s)	Display
1. Turn on Power		METHOD #?
2. Select Stored Program	2 2 5	METHOD ? 225
		DIAL nm TO 522
3. Set Wavelength		522 nm DIAL nm to 522
		. mg/l CaCO ₃ Mg
4. Insert Blank and Set Zero		. WAIT
		0.00 mg/l CaCO ₃ Mg
5. Place Prepared Sample into Cell Holder		WAIT
		1.00 mg/l

Colorimetric testing with Hach's dedicated, pre-programmed calibrations can be divided into four general phases: instrument setup, sample preparation, standardizing the instrument and taking the reading. In the following paragraphs, the scope of each phase is described in detail.

3.2.1 Spectrophotometer Setup

Instrument setup in this test situation is limited to selecting the method or program number assigned to the desired calibration and selecting the wavelength. Prompting messages will appear in the display at the appropriate times to guide the operator through the procedure. The first prompt appears when the instrument is turned on. The message will read:



The method or program number can be entered with the numeric keys or it can be scrolled to, using the up or down arrow keys. Holding the arrow key down allows rapid scrolling. A list of the tests with their numbers is affixed to the underside of the cell compartment cover. To enter the number with the numeric keys, key in the two or three digit number and press the READ/ENTER key. If the number is not valid, the display will read:



After three seconds, the display will return to the prompt for the method number. Reenter the proper method number, or use the following procedure to locate the desired test.

Instead of selecting the method by number, you can use the up or down arrow keys to scroll through the method list and select from the displayed methods. During scrolling, the method number is displayed in the large digits and the unit of measure and symbol for the test subject are displayed in the text area; for example,

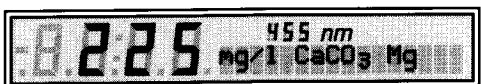

Once the proper method appears in the display, accept by pressing the READ/ENTER key. Upon entry, either by selecting by number or scrolling, the display next prompts you to set the wavelength value; for example,



Adjust the wavelength control as shown in Figure 7 until the nanometer readout displayed matches the prompted value. When the values are equal, press the READ/ENTER key to proceed. You may, however, perform the test with an alternate wavelength by pressing the READ/ENTER key when the alternate value is in the display

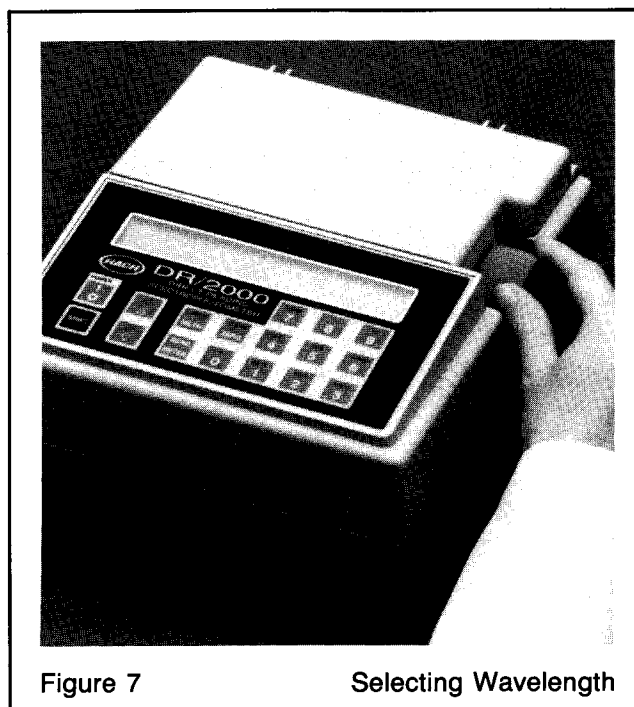

Figure 7

Selecting Wavelength

3.2.2 Sample Preparation

The next task in the colorimetric test is the preparation of the sample. If the zero sample or blank to be used requires some special treatment, it too is prepared at this time. Generally, sample preparation consists of adding the contents of a pre-measured reagent powder pillow to 25 mL of the sample (Figure 8) and allowing time for a color reaction to take place. It is important to observe the waiting period specified in the particular test procedure to be certain that the color (due to the reaction of the reagent with the substance being measured) develops fully. Many procedures also give a maximum time limit after which the color may begin to fade. The DR/2000 Spectrophotometer has color development times programmed into the method software, and the operator is notified with a series of short beeps when the time has elapsed. At

this time the instrument is ready to be zeroed. The timer must be initiated, however, by pressing SHIFT TIMER at the time the countdown should begin. Up to four separate time periods can be incorporated in a test procedure.

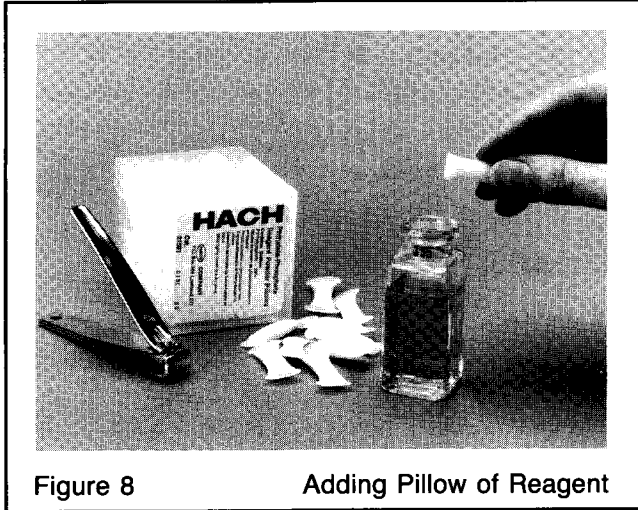

Figure 8 Adding Pillow of Reagent

3.2.3 Zeroing the Spectrophotometer

The instrument must be standardized for each determination. This establishes a zero reference for the measurement and is done by placing a blank solution in the cell holder and setting the instrument to zero concentration units. The display indicating readiness for this function appears as:



Place the zero solution (blank) in the instrument (with the 25-mL mark to the left or right) and press the ZERO key. See Figure 9. If this step is forgotten and you attempt to read a sample, the instrument will remind you that a zero is required with the message:



While the instrument is zero calibrating (which may take up to eight seconds), the display will read:



Figure 9 Placing Blank Solution in Cell Holder

When the zero calibration is completed, the display will show a zero result:



You are now ready to measure the sample.

3.2.4 Taking The Reading

Place the prepared sample into the cell compartment with the 25-mL mark to the left or right as shown in Figure 10, close the compartment cover and press the READ/ENTER key. The display will read:



In about six seconds, the test result will appear; for example:

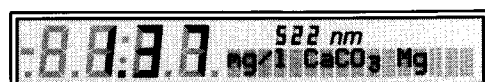

More samples can be measured at this point merely by placing the new sample into the cell holder and pressing the READ/ENTER key. Also, the instrument can be zeroed at any time by placing the zero solution (blank) in the instrument and pressing the ZERG key. To change test parameters, press the METH key. The instrument will revert to the prompt message calling for the method number.



Figure 10

Placing Prepared Sample
in Cell Holder

NOTE

The procedure above is applicable when operating in the momentary mode. When operating in the Constant-On mode, it is not necessary to press the READ/ENTER key to get the reading and the WAIT prompt will not appear.

Test results can be displayed in three forms: concentration, percent transmittance and absorbance. Concentration is shown in the example above. A concentration value can be converted to percent transmittance or absorbance by pressing SHIFT %T or SHIFT ABS, respectively. Pressing SHIFT CONC will return the display to concentration.

3.3 Testing With Operator-Programmed Calibrations

The DR/2000 Spectrophotometer can store positive-slope, user-developed test methods. Accurate results may be obtained for test samples up to two standard

absorbance units. Once a user-generated method has been entered, it can be accessed and run just as the factory-programmed methods. Both timed and untimed methods can be defined. User-entered methods are stored as method numbers 950 through 999, allowing up to 50 additional methods. A method can have up to 16 data points to describe the absorbance-concentration curve, but there is a total limit of 290 data points available. Thus to enter 50 additional methods, calibrations would have to average approximately six data points per method.

To run a user-entered method, select the method either by entering the number or scrolling to the method. The display will scroll to the user-entered area directly following the Hach-stored methods.

3.3.1 Entering A Calibration

Prior to entering a calibration, the operator should prepare a calibration curve of concentration versus absorbance. If the curve is linear, only a few concentration data points are needed to form a good calibration curve. For example, a zero, a standard of approximately 0.5 absorbance and a standard between 0.85 and 0.95 would be appropriate. However, if the calibration is nonlinear, additional data points are needed to achieve good accuracy. Up to sixteen data points can be entered for a single calibration curve. The graph below illustrates why the additional points are necessary. If only points A

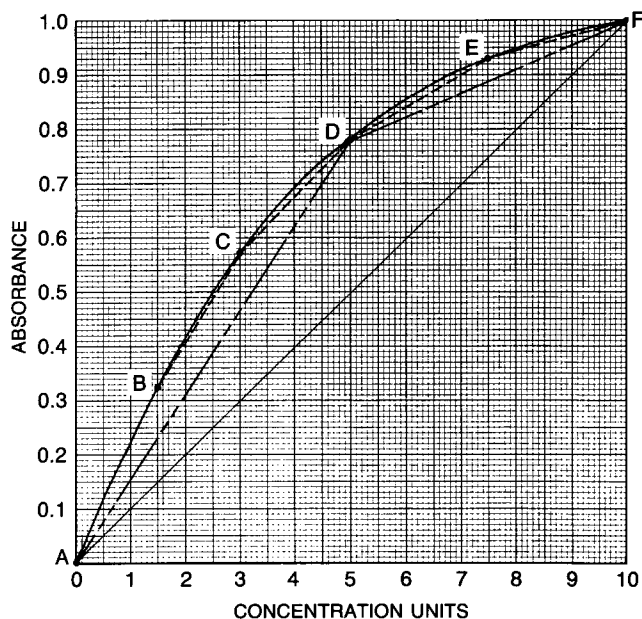

and F were entered, the instrument would base its calculations on a straight line (A-F) and the result would be grossly in error. By adding data point D, the curve is greatly improved with the two straight lines A-D and D-F, but in some regions of the curve, measurements still may not be accurate enough.

Further improvement is gained when data points B, C and E are entered, giving straight lines A-B, B-C, C-D, D-E and E-F.

In general, the calibration data may be entered in up to sixteen data points of a minimum of 0.063 absorbance units for calibrations not exceeding one absorbance unit. If the calibration curve exceeds one absorbance unit, the minimum absorbance between data points may not be less than 0.125. Therefore, if a nonlinear relationship between absorbance and concentration is found, the calibration should not extend above one absorbance unit to achieve the best accuracy.

Entering a new test method requires that the operator utilize the numerous characters in the menu to construct an alpha-numeric description of the test parameter. The list of characters below shows what is included and in what sequence they appear. By holding the up or down arrow keys down, you can scroll through the menu rapidly until you are close to the character being sought and then proceed slowly in steps until the desired character appears in the display. A list of the characters available in the order of their sequence in the menu is given below.

_ abcdefghijklmnopqrstuvwxyz







Entering a User Stored Program

At the end of this exercise, the operator will be able to select the user stored calibration by method number or by scrolling, the same as selecting a factory-programmed method. A sample worksheet for documenting calibrations is provided following page 30. Fill in a copy of the form to record the calibration data for future reference.

CAUTION

Once a user entered calibration procedure has been started, do not terminate the procedure or turn the instrument off before two data points have been entered and the prompt “#2 STANDARD” is displayed. Ending the calibration too soon could cause the loss of all user entered methods and possibly factory monochromator calibration. If an improper entry is made, continue with the procedure and make the necessary corrections later using the Re-Using Operator Stored Method Number, *paragraph 3.5*, or Reviewing and Changing Operator-Programmed Methods, *paragraph 3.4*.

When entering a calibration point value during a user entered calibration, do not attempt to enter a decimal point using SHIFT 0 keys. The decimal point will already be entered via the decimal point selection, and pressing SHIFT 0 (used only as a diagnostic tool during servicing) could erase all user entered memory.

Step	Action/Keystroke(s)	Display
1. Turn on Power		
2. Select User Stored Program Mode	  	

Following the z, a series of special characters appear.

À Á Â Ã Ä Å Ç È É Ê Ë Ì Í Î Ï Ñ Ò Ó Ô Õ Ö Ø Ù Ú Û Ü Ý Þ ß à á â ã

Except for the symbols σ only four different special characters may be used in a single display.

() / 0 1 2 3 4 5 6 7 8 9 + -

Numbers that appear during scrolling are full size. Subscript and superscript numbers are entered from the keyboard and are shown below.

2₂ 3₃ 4₄ 5₅ 6₆ 7₇ 8₈ + -

In the graphics summary below, the three-column presentation provides a brief procedural step, the appropriate keystrokes and the resulting display. It provides a quick reference when performing an operator-programmed test method calibration and intended for use after the operator has become familiar with the instrument operation. A more detailed discussion for first-time user calibrations follows the summary.

3. Set Wavelength Control to 560 and also key in the wavelength to program the instrument

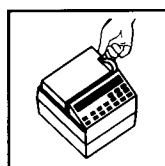

ABS 5 CONC 6 . 0

950 ENTER nm 560

READ
ENTER

950 DECIMAL? 00.00

4. Set Decimal

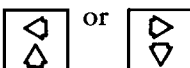

950 DECIMAL? 0.000

READ
ENTER

950 UNITS?

5. Select Units

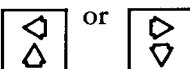

950 mg/l

READ
ENTER

950 SYMBOL?

6. Construct Symbol (e.g. Cu²⁺)

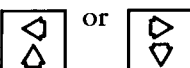

950 mg/l c

Shift to capitalize C

SHIFT

950 mg/l C

READ
ENTER

950 mg/l C_

Scroll to Letter u

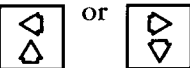

950 mg/l Cu

READ
ENTER

950 mg/l Cu_

Select No. 2

EDIT
2

950 mg/l Cu2

Shift for Superscript

SHIFT

950 mg/l Cu²

READ
ENTER

950 mg/l Cu²_

Select +

SHIFT + 9

950 mg/l Cu²⁺

READ
ENTER

950 mg/l Cu²⁺ _

READ
ENTER

950 TIMER?

7. Set Time to 1:00

SHIFT TIMER
 7

950 MM:SS TIME 1?

Select 01:00

0 BATT 0 0
 1

950 01:00 TIME 1?

READ
ENTER

950 MM:SS TIME 2?

READ
ENTER

950 ZERO SAMPLE

8. Set Zero On Blank

CLEAR
ZERO

950 WAIT

0.000 #0 STANDARD

READ
ENTER

0.000 #0 0.000 mg/l

9. Place Zero Concentration Standard In Cell

READ
ENTER

0.000 WAIT

x.xxx Abs 0.000 mg/L

READ
ENTER

x.xxx #1 STANDARD

10. Place 0.2 mg/l Standard In Cell

READ
ENTER

x.xxx #1 0.000 mg/l

Key In Value 0.2

CAUTION: Do not enter the decimal point (SHIFT 0).

Position of decimal was set in Step 4. "SHIFT 0" is only used as a diagnostic entry by service personnel and could erase user-entered memory.

0 EDIT
 2

x.xxx #1 0.200 mg/l

READ
ENTER

x.xxx WAIT

y.yyy Abs 0.200 mg/l

11. Place 0.4 mg/l Standard In Cell

Key In Value 0.4 **Do not enter decimal point (SHIFT 0).**

READ
ENTER

y.yyy #2 STANDARD

READ
ENTER

y.yyy #2 0.000 mg/l

· 0 %T 4

y.yyy #2 0.400 mg/l

READ
ENTER

y.yyy WAIT

z.zzz Abs 0.400 mg/l

READ
ENTER

z.zzz #3 STANDARD

12. Place 0.8 mg/l Standard In Cell

Key In Value 0.8 **Do not enter decimal point (SHIFT 0).**

READ
ENTER

z.zzz #3 0.000 mg/l

· 0 - 8

z.zzz #3 0.800 mg/l

READ
ENTER

z.zzz WAIT

a.aaa Abs 0.800 mg/l

READ
ENTER

a.aaa #4 STANDARD

13. No Other Standards. End Data Entry and Store Method.

SHIFT READ
ENTER

METHOD #?

To create a new method, answer the method prompt by calling up the user program mode; press: SHIFT PROG METH keys. The instrument determines the next available method number (for instance 954) and the display changes to:



Record the method number displayed for future reference when using the method.

Enter the wavelength of the test you wish to perform using the numeric keys. As the numbers are keyed in, the wavelength digits are forced in from the right, and the displays will progress as follows:



If you make an error entering the wavelength value, press SHIFT CLEAR and re-enter the number correctly. When the proper number is displayed, enter the value by pressing the READ/ENTER key.

The display will now ask you to position the decimal point with the prompt:



Using the cursor keys (left and right arrows), position the decimal point properly and press the READ/ENTER key. The display will now prompt:



Using the scroll keys (up and down arrows), scroll through the available units of measure. Note that the first display in the menu will be blank (no units).

mg/l μg/l g/l ppm Lbs/Ac kg/ha %
g/kg mg/kg mg/100g mg% UNITS FTU
Mol/l mMol/l meq/l Oz/gal

These units will appear sequentially in the display. When the appropriate choice is in the display, press the READ/ENTER key. If the unit you need is not available (for example, GRAINS/GAL or g/m³), select the blank units field (blank precedes mg/l), press READ/ENTER, and construct your own unit using the individual characters as described below in constructing your symbol.

The display now changes to:



To construct the desired symbol, begin by scrolling for the symbol characters. The display will change to show the unit of measure selected and the cursor positioned to begin the symbol. Resume scrolling and continue until the first character of the symbol is in the display. For example, to construct a display for a low-range test of SO₄²⁻, scroll to obtain the letter s in the display. Holding the arrow key down provides rapid scrolling through the alphabet. **The letter will be lower case and must be changed to an upper case S by using the shift key.** Accept the S with the READ/ENTER key and move to the next space. Scroll for the letter o, capitalize the letter to O and accept it with the READ/ENTER key. Move to the next space. Enter a 4 from the keyboard. It will appear as a subscript number, and since a subscript is desired, press the READ/ENTER key to accept. Press 2 on the keyboard. **The 2 will also appear as a subscript and must be changed to a superscript by pressing the SHIFT key.** Press READ/ENTER. Key in a minus sign and press the READ/ENTER key. The keyboard-entered minus and plus signs display only as superscripts, so they do not need to be shifted. Subscripts available are 2 through 8, and superscripts available are 2 through 6, + and -. There is a limit of four different custom symbols per message.

To distinguish this low range sulfate method from the sulfate method already in memory, you can add LR at the end of the symbol field in the display. Scroll to the blank space character. During scrolling, the blank appears between the underline and the letter "a." Accept it with the enter key. You can enter up to four blank spaces and then enter the L and R. After examining the display to see that everything is correct, press the READ/ENTER key a second time to accept and store the entire display. The display will now change to:



If this is to be a timed procedure, press SHIFT TIMER. The next prompt will be:



The interval for the first timed period is now entered, one digit at a time, using the number keys. The numbers will appear in place of MM:SS. When the correct minutes and seconds are shown in the display, press the READ/ENTER key to store the interval in memory. At this point, the display will prompt:



If more timed intervals are needed, repeat the above procedure. Up to four time intervals can be stored. When all interval entries are complete, store the entire sequence by pressing READ/ENTER once if all four intervals are used or two times if less than four are entered. The timer sequences can be bypassed entirely when the timer is not needed by pressing READ/ENTER in response to the timer prompt. In either case, the next prompt message will be:

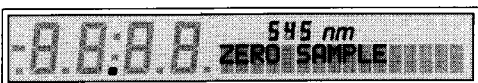

Place the zero solution in the cell holder, close the cover and press the ZERO key. The instrument will perform a zero calibration, and while doing so will display:



followed by a display prompting:

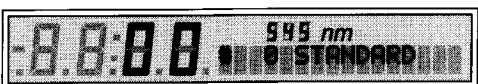

With the blank sample still in the instrument, press the READ/ENTER key. The display will change to read:

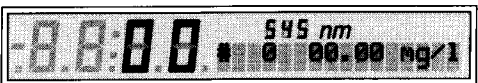

Accept the displayed zero concentration value by pressing READ/ENTER. The display will change to:

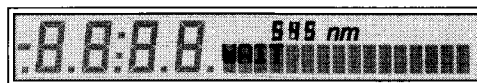

while the instrument performs a zero absorbance calibration. On completion, the display will change to:



Accept the zero point for the calibration curve by pressing READ/ENTER. The next prompt will ask for the next standard; that is:



Insert the first or weakest standard in the cell holder and press READ/ENTER. The display will change to:

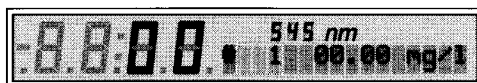

Key in the desired concentration;

for example:



All four digits must be entered, including any leading zeroes to the left of the decimal. The decimal point is already positioned according to your earlier choice. A wrong keystroke can be corrected by using the shift, left arrow key to backspace over an incorrect entry. Accept the correct entry with the READ/ENTER key. The display will first read:



and then show the absorbance value for the measured standard in addition to the concentration; that is:



Press READ/ENTER. The data pair (concentration and absorbance) will be stored in memory as calibration data point number 1. The display will now prompt you for the next standard:



Repeat the above procedure for entering standard 1 for all calibration standards. When all calibration data points have been entered, conclude the calibration by pressing SHIFT, READ/ENTER. The display will now prompt:

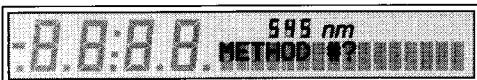

If only one calibration standard is measured, a straight line between that point and the origin (0, Abs, 0 Conc) is calculated, and measurements will be linearly interpolated along that line. If two or more data points (up to a maximum of 16) are entered, the DR/2000 Spectrophotometer constructs a point-to-point straight line approximation of the curve, beginning at zero-zero and ending at a point which is the next 0.125 absorbance interval above the highest input value.

The procedure is stored, program mode terminated and instrument returned to regular operation with

the completed user-method selected. For future use of the user-stored method, either scroll to the method or enter the number with the keypad. The example above would, for instance, be recalled by keying in 954 in response to the method prompt.

For all calibrations, any measured absorbances greater than approximately 10 percent above the highest entered calibration absorbance will result in the message:



If the memory is filled during entering a new method, the display will blink off and on, indicating there is no more memory available and the method can not be completed. Exit this condition by turning the instrument off.

It will be necessary to evaluate the user-entered methods and determine if something can be eliminated to make room for the new method. Refer to 3.5 Re-Using Operator-Stored Method Number. It will be beneficial to maintain a log of the operator-stored methods both as a record of what is in memory in case of accidental loss or a ROM update and as a review document to evaluate for changing test requirements. Figure 11 provides a sample record form that would meet these needs.

FIGURE 11. sample

USER-ENTERED CALIBRATIONS WORKSHEET

Test Name: VANADIUM Pentavalent Test Method: PAR Date: 2-29-88 By: Example

METHOD #? BEGIN USER PROGRAM MODE
Press SHIFT PROG METH.
Record the number displayed by the DR/2000: 954

ENTER nm ENTER THE WAVELENGTH
Key in the desired wavelength value and record it here: 550
Make corrections by pressing SHIFT CLEAR and re-entering the wavelength.
When you have correctly keyed the wavelength, press READ/ENTER.

DECIMAL? \downarrow 00.00 POSITION THE DECIMAL POINT
Use the arrow keys to position the decimal point; record it here: 0.000
Press READ/ENTER to accept the decimal position.

UNITS? \updownarrow SELECT THE UNIT OF MEASUREMENT
Use the arrow keys to select the desired unit, record it here: mg/l
To construct a unit of measure - accept blank field; go to next step.
Press READ/ENTER to accept the unit or blank selection.

SYMBOL? \updownarrow CONSTRUCT THE CHEMICAL SYMBOL
Use the arrow keys to select the characters.
Press READ/ENTER to accept each character.
Make corrections with SHIFT LEFTARROW or SHIFT CLEAR.
When completed, record both unit and symbol here: mg / l V5+
Press READ/ENTER to record the entire construction.

TIMER? SET THE TIMERS (OPTIONAL)
To bypass entry of the optional timers, press READ/ENTER at the timer prompt.
If you wish to set timers, press SHIFT TIMER.
Record each timer you have set in the spaces below:
Enter all four digits including leading zeroes.

MM:SS TIMER 1 ?	30:00	MM:SS TIMER 3 ?	
MM:SS TIMER 2 ?		MM:SS TIMER 4 ?	

Press READ/ENTER when you have completed entering timer values.

ZERO SAMPLE PERFORM A ZERO CALIBRATION
Insert a prepared blank sample and press READ/ENTER.

0 STANDARD SET THE ZERO CONCENTRATION POINT
Leave the blank sample in the well and press READ/ENTER.
Begin calculation of the concentration - absorbance zero point by pressing READ/ENTER.

ENTER THE ABSORBANCE - CONCENTRATION DATA PAIRS.
Enter the concentration values of your prepared samples in the table below.
Follow the steps outlined for entry and calculation of each point.

	Press	Enter & record Concentration	Press	Record Displayed Absorbance	Press
# 1 STANDARD	READ/ENTER	.200	READ/ENTER	0.339 (0.200)	READ/ENTER
# 2 STANDARD	READ/ENTER	.400	READ/ENTER	0.678 (0.400)	READ/ENTER
# 3 STANDARD	READ/ENTER	.600	READ/ENTER	1.017 (0.600)	READ/ENTER
# 4 STANDARD	READ/ENTER		READ/ENTER		READ/ENTER
# 5 STANDARD	READ/ENTER		READ/ENTER		READ/ENTER
# 6 STANDARD	READ/ENTER		READ/ENTER		READ/ENTER
# 7 STANDARD	READ/ENTER		READ/ENTER		READ/ENTER
# 8 STANDARD	READ/ENTER		READ/ENTER		READ/ENTER
# 9 STANDARD	READ/ENTER		READ/ENTER		READ/ENTER
# 10 STANDARD	READ/ENTER		READ/ENTER		READ/ENTER
# 11 STANDARD	READ/ENTER		READ/ENTER		READ/ENTER
# 12 STANDARD	READ/ENTER		READ/ENTER		READ/ENTER
# 13 STANDARD	READ/ENTER		READ/ENTER		READ/ENTER
# 14 STANDARD	READ/ENTER		READ/ENTER		READ/ENTER
# 15 STANDARD	READ/ENTER		READ/ENTER		READ/ENTER
# 16 STANDARD	READ/ENTER		READ/ENTER		READ/ENTER

METHOD #? END USER PROGRAM MODE
When you have entered at least one point but not more than sixteen points
conclude the entry of data pairs by pressing SHIFT READ/ENTER

SELECT A METHOD
At the method prompt you may now select your new method and perform a test.

Figure 11 Sample User-Entered Calibrations Worksheet

3.3.2 Completing the Test

Once the user-generated calibration is accepted with the SHIFT, READ/ENTER keystrokes, the instrument is ready to measure an unknown sample, beginning with selecting the new method number. Now select the wavelength and zero the meter with a blank sample. Then the sample is placed into the cell holder, the cover closed and the READ/ENTER key pressed. The display will read:



followed in about six seconds with the test result, such as:



A new sample can be inserted and tested. At any time, the instrument can be re-zeroed by inserting the blank sample and pressing the ZERO key.

3.3.3 Alternate Method For Entering A Calibration

Another method for entering new calibrations prescribes using a single standard for all calibration points to enter a flat curve (that is, all calibration points have the same absorbance), and later using the edit procedure as described in paragraph 3.4 to manually correct the absorbance values to establish the proper curve.

If you use this alternate method, you must enter the proper number of calibration points because you cannot add a calibration point in the editing procedure. After entering a flat calibration, pressing SHIFT ENTER to return to the method prompt will cause the instrument to lock up where it fails to respond to any further keystrokes. Turn the instrument off and back on again. The flat calibration will now be stored and it can be edited to establish the correct curve. Refer to *Reviewing and Changing Operator-Programmed Methods*, paragraph 3.4.

3.4 Reviewing and Changing Operator-Programmed Methods

Data pair information stored previously by the operator can be reviewed and changed to correct or modify bad data points. If you wish to change other components of the user method (i.e., the display) or increase the number of data points, you must reenter the method from the beginning. To select an operator-entered method for review or modification, enter the method number as usual followed by pressing SHIFT,EDIT. The method number will be

displayed in the large digits and the data pairs in the alpha-numeric field as:

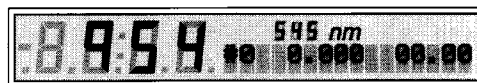

The previous example shows the display for the zero point for the method 954 example. To accept the zero point and proceed to review the data pairs, press READ/ENTER. The display will show the next data pair, for example:

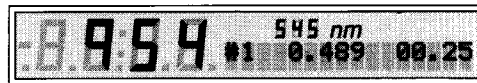

The cursor is positioned under the first digit of the absorbance value. You can move from digit to digit with the arrow keys, changing any numbers you wish to correct. For instance to change the concentration in the above example to 00.15, press the right arrow key six times to position the cursor under the 2 and key in the new number (1). The new number will replace the old and the cursor will advance to the next digit as:

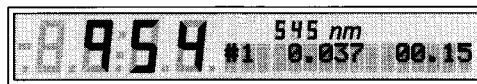

Then either press the right arrow key one more time to advance past the last number, or press READ/ENTER. Either action will accept the modified pair and go on to the next point:

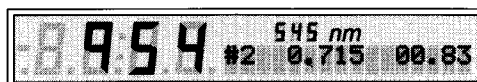

Repeat this procedure for each data point, either accepting the values as they are, or making any modifications required. When the data from the last data point has been reviewed and accepted by pressing READ/ENTER, the set will be stored and the display will return to method prompt:

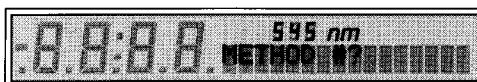

You can now reenter the number of the modified method and perform the test.

With the review and edit process, it is not possible to add or subtract data points to a method. You may, if necessary, replace a bad data point in a curve by interpolating a new value for the point based on the preceding and following points.

3.5 Re-Using Operator-Stored Method Number

It may be desirable to obsolete a user stored calibration in favor of a new one if memory capacity becomes filled. This can be accomplished by calling up the method number to be re-used and then proceeding with the normal procedure for entering a user method. For example, to use user-method number 951 for a new calibration, proceed as follows:

1. Using the numeric keys, key in 951 in response to the method prompt when the instrument is first turned on.
2. Press SHIFT, PROG, METH. The display will show the number and request the wavelength. From this point on, follow the procedure *described in paragraph 3.3.1, Entering A Calibration, beginning with entering the wavelength.*

3.6 Erasing All Operator-Stored Methods

Provision is made to allow the operator to erase the entire group of operator-stored methods. They can not be erased individually. If you wish to clear this part of the memory, proceed as follows:

Press the SHIFT, CONFIG keys. The display will show:



Enter the number 888 and press the READ/ENTER key. Within two seconds, enter the number 951. All user-entered methods that have been stored will be cleared from memory.

3.7 Configure Programming

For most operations, the DR/2000 Spectrophotometer is ready to use as shipped. There are options, however, to adapt the instrument for specific purposes. These include choosing a language other than English for prompts and messages, selecting one of two lamp modes, selecting the printer output interval and choosing the presence or absence of an audible tone when keys are pressed. Programming selections for language and lamp mode can be made by entering the number or by scrolling through the configure menu. Programming options that are currently selected are flagged by a darkened rectangle at the right of the display. Selecting these options in the most efficient way would set the language first, then the lamp option (momentary or constant on) and finally the printer frequency. The tone option is independent of the configure menu

and can be selected at any time. Details of the configure programming are described in the following paragraphs.

3.7.1 Language Selection

Thirteen languages in addition to English are available with this spectrophotometer. They can be selected by number or by scrolling through the configure menu and then accepting the choice by pressing the READ/ENTER key. Once selected, the language will be retained when the instrument is turned off. The menu entries, number and name, appear as follows:

801	ENGLISH (English)
802	FRANCAIS (French)
803	ITALIANO (Italian)
804	ESPAÑOL (Spanish)
805	PORTUGUES (Portuguese)
806	DEUTSCH (German)
807	NEDERLANDS (Dutch)
808	NORSK (Norwegian)
809	SVENSKA (Swedish)
810	DANSK (Danish)
811	SUOMI (Finnish)
812	TURKÇE (Turkish)
813	ΕΛΛΗΝΙΚΑ (Greek)
814	日本語 (Japanese)

Proceed as follows:

1. Press SHIFT, CONFIG. The display will read:



2. Key in the number of the language or scroll with the down arrow until the language is displayed and press READ/ENTER. The display will read:



If a language other than English has been selected and you wish to return to English, press the SHIFT and CONFIG keys followed by the READ/ENTER key. English is the default language.

3.7.2 Choosing the Lamp Mode

All configure options are selected through the configure menu which is called up by pressing the SHIFT CONFIG keys. The display will read:



You can select a configure mode by keying in the number or by using the up or down arrow key to scroll through the configure menu until the display indicates:



or



whichever mode is desired. (Momentary is the default mode.) With the desired mode in the display, press the READ/ENTER key. If the momentary mode was selected, the lamp will light only long enough to take the measurement after the ZERO or READ key is pressed. The instrument automatically turns off, to save battery power five minutes after the last key stroke. In the constant-on mode, the lamp and display stay on at all times the instrument is turned on. Hach recommends the constant-on mode only when working in the laboratory on battery eliminator/charger power.

3.7.3 Choosing Printer Output Frequency

Printer output selection is the third function in the configure menu, following language selection and lamp mode selection. After the lamp mode (momentary or constant on) is selected with the READ/ENTER key, the prompt for the print frequency will be displayed:



Use the numeric keys to select the print interval in seconds (5-99) and enter with the READ/ENTER key. The display will return to the method prompt.



If the instrument is set in the momentary mode, printer data will be transmitted automatically at the end of each test. In the Constant On mode, printer data will be transmitted at the interval selected. The instrument can be programmed to print "on demand only" in the Constant On mode by selecting 0 seconds. A printout is then initiated by pressing the READ/ENTER key.

3.7.4 Tone Generator

The tone generator is toggled on and off by holding the SHIFT key down until a beep is heard. When

on, the beep will sound each time a key is pressed, indicating that the keystroke has been accepted by the instrument. Without the tone, more care is called for when using the keyboard. Watch the display to see that the keystroke has been accepted.

3.8 Using the Pour-Thru Cell

The Pour-Thru Cell is an optional accessory that improves accuracy and convenience. It is particularly advantageous for measurements of very low concentrations. Because the same optical characteristics exist for both standardizing and measuring or when comparing measurements of different samples, any error that would result from optical differences between individual sample cells is eliminated. Assembly of the Pour-Thru Cell is described in Section 2. Install the Pour-Thru Cell in the spectrophotometer as follows:

1. Examine the glass windows in the Pour-Thru Cell. If either is dirty or smudged, clean with a soft, lint-free cloth or optical tissue.
2. Insert the Pour-Thru Cell into the instrument cell holder with the windows aligned with the windows in the cell holder. See Figure 12. Be sure the Pour-Thru Cell is fully inserted to prevent any light leak around the gasket. The cell compartment cover can remain open when using this accessory.

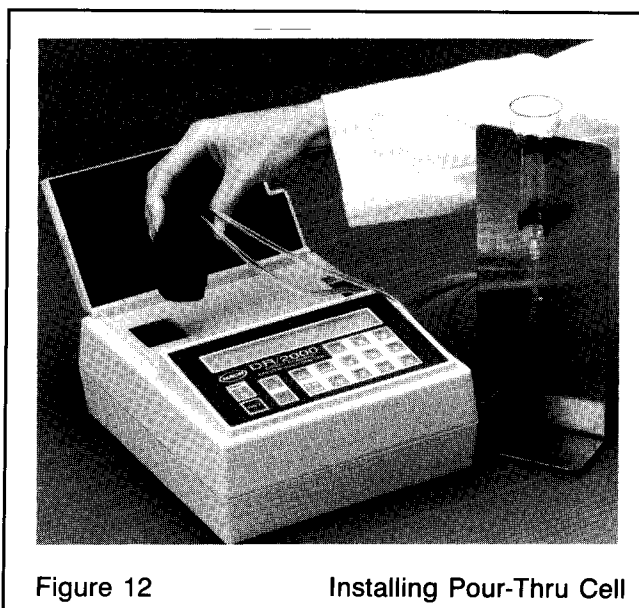

Figure 12

Installing Pour-Thru Cell

3. Adjust the relative heights of the stand pipe and funnel to ensure proper drainage for the funnel. The funnel should drain completely with the final level of liquid in the tube about 5 cm (2 inches) below the tip of the funnel. Initially, adjust the stand pipe so that the inlet is 5 cm below the tip of the funnel. See Figure 5.

4. Pour 25 to 50 mL of deionized water into the funnel and allow the funnel to drain. If necessary, move the stand pipe up or down to achieve the proper liquid level. When properly adjusted, the funnel will drain smoothly and stop draining at the correct level.

The drain tube attached to the stand pipe must be allowed to drain freely. It should always remain below the outlet of the stand pipe and should not run horizontally any more than necessary. Preferably, the tube should be as short as possible with the outlet end inserted into a drain (or suitable collecting vessel if treatment is necessary before discharge).

3.9 Using the AccuVac Vial Adapter

Hach Company's line of AccuVac Ampul reagents can be used in the DR/2000 Spectrophotometer with the aid of the adapter provided in the accessories. Test procedures for the AccuVac reagents are designated as such both in the procedure manual and in the list of methods on the underside of the cell compartment cover. Reagents are contained in sealed, evacuated vials and are mixed with the water sample by partially immersing the ampul and breaking off the tip to allow sample to be drawn in. Reacted sample can be measured in the ampul once the adapter is installed in the instrument. Proper orientation of the adapter in the sample cell compartment places the grip tab of the adapter toward the back of the compartment. See Figure 13.

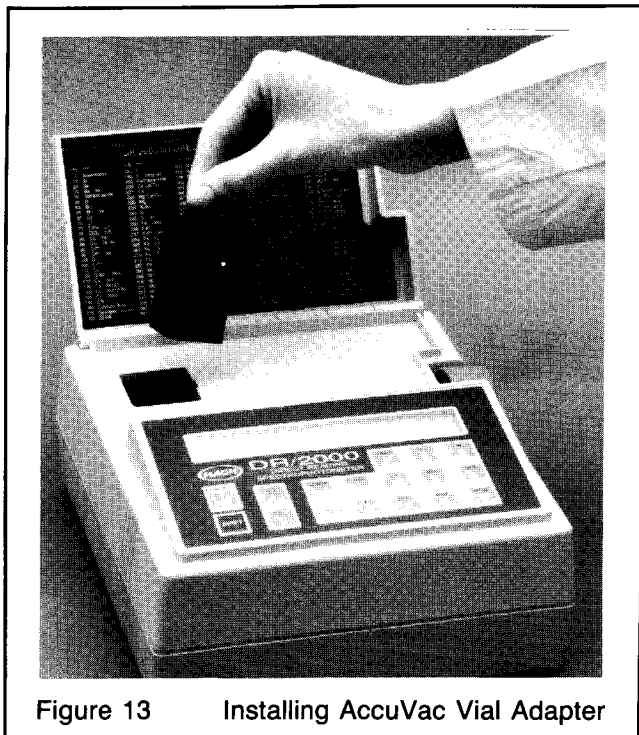

Figure 13 Installing AccuVac Vial Adapter

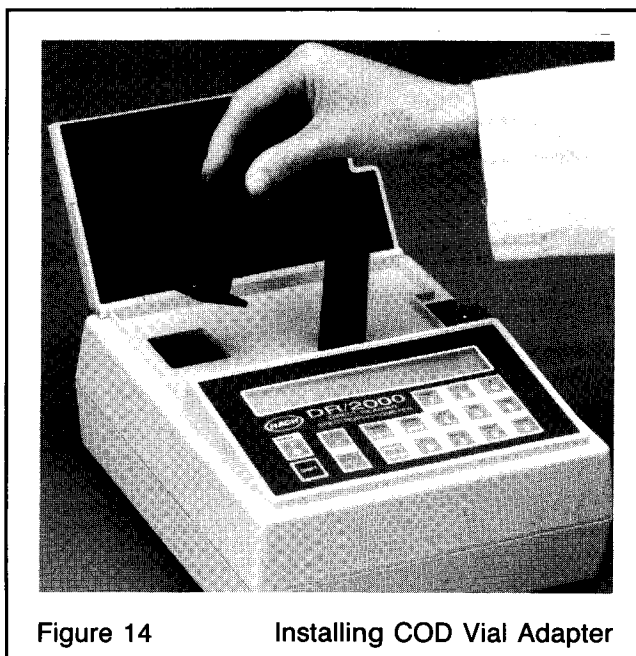

Figure 14 Installing COD Vial Adapter

3.10 Using the COD Vial Adapter

One of the methods for chemical oxygen demand (COD) determinations included in the DR/2000 Procedures Manual uses a COD Reactor and premixed reagent vials for both the digestion process in the reactor and for making the colorimetric measurement. With the COD Vial Adapter installed in the spectrophotometer sample cell compartment, reagent vials can be placed in the instrument for measurement. The COD Vial Adapter also can be used to hold a standard 16-mm test tube.

The COD vial adapter can be placed in the instrument's sample cell compartment with the orientation mark either toward the left or right. See Figure 14. A light shield cover is included with the adapter and must be in place when taking the COD measurement. The cell compartment cover will remain open.

3.11 Using the 1-cm Cell Adapter

Standard 1-cm square cuvettes can be used with the DR/2000 Spectrophotometer when Hach's 1-cm adapter is installed in the cell holder. One-centimeter cuvettes are not supplied with the instrument but are available as optional accessories either individually or in matched pairs.

The adapter is placed in the instrument cell compartment with the handling tab to the rear. See Figure 15. This position will orient the adapter correctly in the light path. When using glass cuvettes, place them in the adapter with the clear sides in the left-to-right optical path. The cell compartment cover must be closed while taking readings.



Figure 15 Installing 1-cm Cell Adapter

3.12 Using the 13-mm Test Tube Adapter

This test tube adapter is placed in the instrument cell holder with the orientation mark either to the right or left. See Figure 16. Proper placement is necessary to match the left-to-right light path. Because of the height of the test tube, the adapter comes with its own light shield which must be in place when readings are taken. The cell compartment cover will remain open.

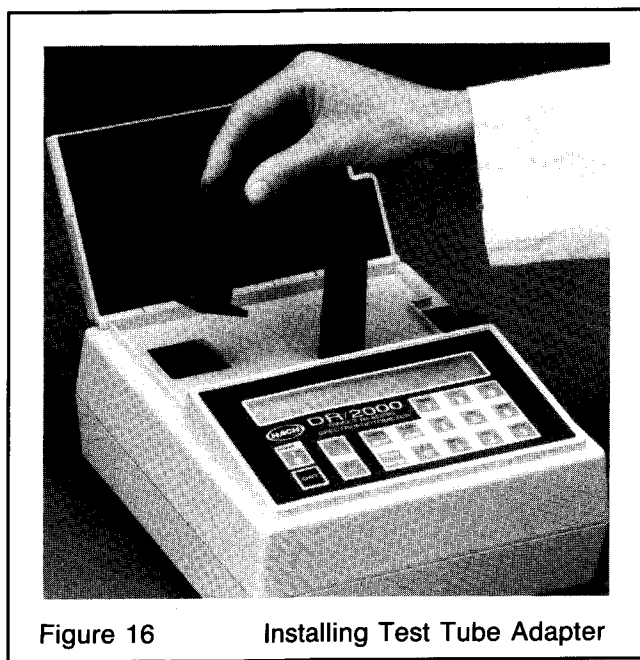

Figure 16 Installing Test Tube Adapter

3.13 Using a Printer

A permanent record of test results can be obtained by using the RS-232 serial output to drive a printer. Figure 17 provides a sample printout from the forty-column personal printer listed in the optional accessories in Section 6. When operating in the momentary mode, a data string will be transmitted to the printer at the end of a test cycle after the READ/ENTER key is pressed to obtain the sample measurement. Operation in the constant-on mode provides a printout according to the frequency selected and does not require the READ/ENTER keystroke. Refer to paragraph 3.7.3 Choosing Printer Output Frequency.

Because the spectrophotometer programming for printer operation provides for a carriage return and line feed, printers with carriage returns (CR) must be configured to avoid the carriage return. In the case of the Citizen printer listed as an optional accessory in Section 6, it means setting jumpers 1 through 5 of Preset Jumper 1. Refer to "Setting the Preset Jumper" in the Citizen Printer manual. The five jumpers of Preset Jumper 1 should be set as follows: jumpers 1, 2 and 4 open, jumpers 3 and 5 closed.

UNIT OF MEASURE	CONCENTRATION OF TEST SAMPLE	WAVELENGTH	ABSORBANCE OF TEST SAMPLE	%T
135	00.00 mg/l	0.000	100.0	560
135	00.08 mg/l	0.025	94.4	560
135	00.19 mg/l	0.060	87.1	560
135	00.28 mg/l	0.088	81.5	560
135	00.38 mg/l	0.117	76.3	560
135	01.00 mg/l	0.300	50.0	560

Figure 17 Sample Printer Format

3.14 Using a Recorder

The recorder output provided is 0 to 1 V and linear from 0 to 100 %T and 0 to 2 ABS units. It also is linear with concentration measurements. For the factory programmed calibrations, the full-scale limits are predetermined for each stored program. Refer to Table 2 for these settings when setting up the recorder. In user-entered calibrations, the recorder full scale is equal to the concentration of the last data point entered. The recorder output is in steps of 5 mV from 0 to 1 volt.

When using the DR/2000 Spectrophotometer with an analog recorder, the 100 percent output level at the recorder is set to a predetermined value for each stored program. Those values are shown below under "limit."

Table 2. Full-Scale Limits

#	limit	units	chemistry
009	.250	mg/l	aluminum (ECR)
010	1.00	mg/l	aluminum
020	125.	mg/l	barium
025	125.	mg/l	barium (AV)
030	20.0	mg/l	benzotriazole
040	15.0	mg/l	boron
050	5.00	mg/l	bromine
055	5.00	mg/l	bromine (AV)
060	200.	µg/l	cadmium
070	25.0	mg/l	chloride
072	1.25	mg/l	chlorine dioxide, (low range)
075	700.	mg/l	chlorine dioxide, (high range)
080	2.50	mg/l	chlorine, free & total
085	2.50	mg/l	chlorine, free & total (AV)
090	1.00	mg/l	chromium, hexavalent
095	1.00	mg/l	chromium, hexavalent (AV)
100	1.00	mg/l	chromium, total
105	25.0	g/l	chromium, trivalent
110	2.50	mg/l	cobalt
120	600.	units	color
130	15.0	ppm	copper in soil
135	6.00	mg/l	copper, Bicinch.
140	6.00	mg/l	copper, Bicinch. (AV)
145	250.	µg/l	copper, Porph.
160	.250	mg/l	cyanide
170	75.0	mg/l	cyanoic acid
180	500.	µg/l	diethylhydroxylamine
190	2.50	mg/l	fluoride
195	2.50	mg/l	fluoride, ampules
200	500.	µg/l	formaldehyde, (low range)
220	5.00	mg/l	hardness, calcium as CaCO ₃
221	2.00	mg/l	hardness, calcium
225	5.00	mg/l	hardness, magnesium as CaCO ₃
226	600.	mg/l	hardness, magnesium
230	600.	µg/l	hydrazine
240	7.50	mg/l	iodine
242	7.50	mg/l	iodine (AV)
250	75.0	ppm	iron in soil
255	3.50	mg/l	iron, ferrous
257	3.50	mg/l	iron, ferrous (AV)
260	1.50	mg/l	iron, total (FerroZine)
265	3.50	mg/l	iron, total (FerroVer)
267	3.50	mg/l	iron, total (FerroVer) (AV)
270	2.00	mg/l	iron, total (TPTZ)
272	2.00	mg/l	iron, total (TPTZ) (AV)
280	200.	µg/l	lead
283	200.	µg/l	lead, fast column extraction
286	75.0	µg/l	lead, anion exchange
290	.750	mg/l	manganese (low range)
295	25.0	mg/l	manganese (high range)
300	250.	ppm	manganese in soil
315	35.0	mg/l	molybdenum (low range)
320	40.0	mg/l	molybdate (high range)
330	8.00	g/l	nickel, autocatalytic
335	2.00	mg/l	nickel, heptoxime
340	1.20	mg/l	nickel, PAN
351	.500	mg/l	nitrate (low range)
353	5.00	mg/l	nitrate (medium range)
355	35.0	mg/l	nitrate (high range)

#	limit	units	chemistry
358	5.0	mg/l	nitrate (medium range) (AV)
360	35.0	mg/l	nitrate (high range) (AV)
363	2.00	%	nitrogen (nitrate) in plants, NV-V
366	75.0	ppm	nitrogen (nitrate) in soil
367	300.	Lbs/Ac	nitrogen (nitrate) in soil
368	350.	kg/ha	nitrogen (nitrate) in soil
371	.400	mg/l	nitrite (low range)
373	200.	mg/l	nitrite (high range)
375	.350	mg/l	nitrite (low range) (AV)
380	3.00	mg/l	nitrogen (ammonium) Nessler
385	.750	mg/l	nitrogen (ammonium) Sal Sea
391	500.	ppm	nitrogen (ammonium) in soil, A/F
392	1000.	Lbs/Ac	nitrogen (ammonium) in soil, A/F
393	1000.	kg/ha	nitrogen (ammonium) in soil, A/F
399	200.	mg/l	nitrogen, total Kjeldahl
410	100.	ppm	oil in water
420	6.00	%	organic matter in soil
430	200.	mg/l	oxygen demand, chemical, react.
435	2000.	mg/l	oxygen demand, chemical, react.
440	1000.	mg/l	oxygen demand, chemical, reflux
445	15.0	mg/l	oxygen, dissolved (high range)
446	1000.	µg/l	oxygen, dissolved (low range)
448	50.0	mg/l	oxygen, dissolved (s high range)
450	1.50	mg/l	ozone, DPD
452	1.50	mg/l	ozone, DPD (AV)
454	1.00	mg/l	ozone (indigo) (low range) (AV)
455	1.00	mg/l	ozone (indigo) (mid range) (AV)
456	2.00	mg/l	ozone (indigo) (high range) (AV)
460	300.	mg/l	palladium
470	.250	mg/l	phenols
480	50.0	mg/l	phosphate, reactive (molybd.)
481	20.0	mg/l	phosphorus, reactive (molybd.)
485	35.0	mg/l	phosphate, reactive (amino acid)
486	10.0	mg/l	phosphorus, reactive (amino acid)
490	3.00	mg/l	phosphate, reactive (PhosVer)
491	1.00	mg/l	phosphorus, reactive (PhosVer)
492	3.00	mg/l	phosphate, reactive (PhosVer) (AV)
493	1.00	mg/l	phosphorus, reactive (PhosVer) (AV)
500	30.0	mg/l	phosphonates
510	.500	%	phosphorus in plant tissue
521	1000.	ppm	phosphorus in soil PhosVer 3
522	500.	Lbs/Ac	phosphorus in soil PhosVer 3
523	600.	kg/ha	phosphorus in soil PhosVer 3
531	100.	ppm	phosphorus in soil PhosVer 4
532	200.	Lbs/Ac	phosphorus in soil PhosVer 4
533	200.	kg/ha	phosphorus in soil PhosVer 4
550	25.0	mg/l	polyacrylic acid LMW-10
555	25.0	mg/l	polyacrylic acid LMW-20
560	25.0	mg/l	polyacrylic acid LMW-45
630	800.	mg/l	residue, nonfilterable
640	1.50	mg/l	selenium
650	2.000	mg/l	silica (low range)
655	120.0	mg/l	silica (high range)
660	.75	mg/l	silver
670	1500.	mg/l	sodium chromate
680	75.0	mg/l	sulfate
685	75.0	mg/l	sulfate (AV)
690	.750	mg/l	sulfide
700	.500	%	sulfur (sulfate) in plant tissue
705	50.0	ppm	sulfur (sulfate) in soil
710	.300	mg/l	surfactant, anionic
720	10.0	mg/l	tannin & lignin
730	25.0	mg/l	tolytriazole
750	500.	FTU	turbidity
770	3500.	mg/l	volatle acid
780	2.50	mg/l	zinc
790	25.0	ppm	zinc in soil

SECTION 4 MAINTENANCE

4.1 Cleaning

4.1.1 Spectrophotometer

The spectrophotometer and sample cells should be kept clean at all times and spills should be wiped up promptly. The photocell window, located on the left-hand side of the cell holder, can be wiped with lens tissue or a soft, lint-free cloth that will not leave an oil film.

4.1.2 Sample Cells

Sample cells should be cleaned with detergent, rinsed several times with tap water and then rinsed thoroughly with deionized water. Sample cells used with organic solvents (chloroform, benzene, toluene, etc.) should be rinsed with acetone before the detergent wash and again as a final rinse before drying. If other special cleaning procedures are needed for a particular test, they are detailed in the test procedure.

4.1.3 Pour-Thru Sample Cell

Remove the pour-thru cell occasionally to check for accumulation of film on the windows. If the windows appear dirty or hazy, soak in a detergent bath and then rinse thoroughly with deionized water. Always rinse thoroughly with deionized water between tests. Do not use solvents (e.g., acetone) to clean the pour-thru cell. The pour-thru cell can be disassembled for cleaning if necessary.

4.2 Replacement Instructions

4.2.1 Battery Replacement

The battery power source must be replaced or recharged whenever a LOW BATTERY message appears in the display. If D-size dry cell batteries are being used, all six should be replaced, and if a rechargeable battery is installed, recharge as soon as possible. Generally, 18 to 24 hours is adequate to return the battery to full charge. Refer to paragraph 2.2.2 for battery installation instructions for D-cell replacement.

4.2.2 Lamp Replacement

If the monochromator lamp fails and must be replaced as determined by information in paragraph 5.2.4 LAMP OUT Display, proceed as follows.

1. Disconnect power to the instrument and empty the cell holder. Place the instrument upside down on a padded surface.
2. Remove the two screws securing the lamp compartment cover and remove the cover. See Figure 18.
3. Remove the lamp retainer screw and metal sleeve from the lamp channel. The sleeve is tapered at the bottom end and, because of its snug fit,

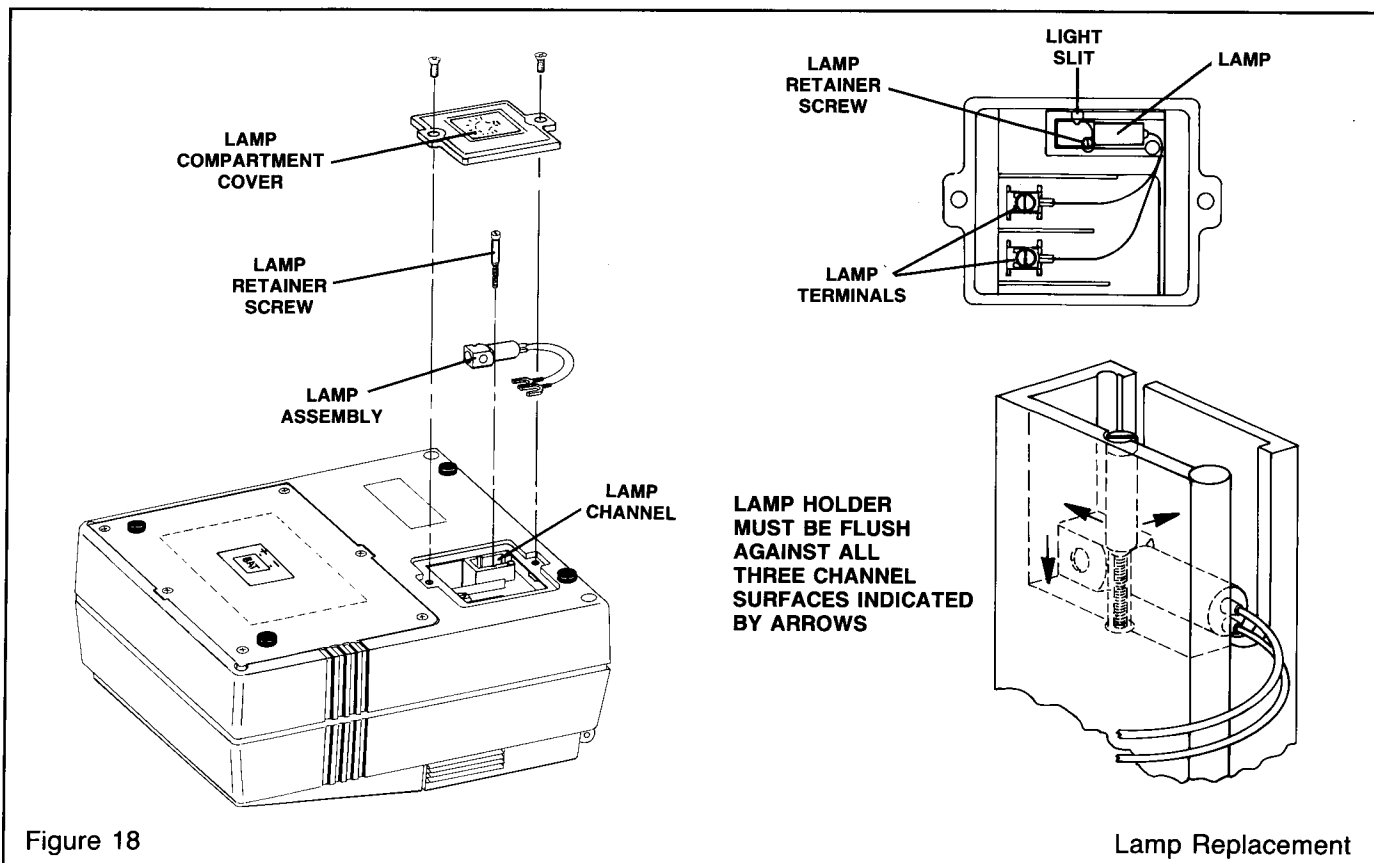

Figure 18

Lamp Replacement

probably will need to be loosened with a tool (needle-nose pliers recommended) for removal. Remove the lamp. Loosen the two terminal screws to free the lamp leads.

- Place the lamp in the lamp channel with the lamp light slit toward the light slit in the lamp channel. Push the lamp to the bottom of the lamp channel, install and firmly tighten the lamp retainer screw and sleeve in the channel to secure the lamp. The lamp must be held tightly in the proper position, flush against the bottom, end, and light slit side of the lamp channel. See Figure 18. Connect the lamp leads of the new lamp assembly at the lamp terminals (lead orientation does not matter). Do not overtighten.
- Install the lamp compartment cover. Return the instrument to the upright position and restore power.

4.3 Wavelength Accuracy Check

A wavelength accuracy check can be performed using a holmium based test solution. A premeasured volume of holmium trichloride powder, appropriate for 25 mL of the test solution, is available in powder pillow form for this test. This test is only a secondary check of the wavelength accuracy and does not indicate the absolute nanometer value.

- Fill a clean sample cell with 25 mL of demineralized water. Add the contents of one Holmium Trichloride Powder Pillow and swirl to dissolve.
- Call up the configure menu by pressing SHIFT CONFIG. When the display shows



use the edit keys to scroll for a display of:



- Press READ/ENTER to accept the constant on mode and return to the method prompt:



- Turn the Wavelength Control for a reading of 460 nm. Press READ/ENTER to enter the absorbance mode.
- With the cell holder empty and the cell compartment cover closed, perform a zero calibration by pressing ZERO.
- Insert the sample cell containing the Holmium Solution into the cell holder and close the cell compartment cover.
- Slowly turn the Wavelength Control counterclockwise in 1-nm increments, pausing between increments and watching the display for a peak reading. Note the approximate nanometer value at the peak. Return to a somewhat higher wavelength and repeat the process until you can stop the control with the highest absorbance value displayed. Always approach the peak value from the high wavelength side (turning counterclockwise). Without moving the control from its peak setting, read the wavelength setting. If the wavelength at the peak is 451 ± 5 nm, the instrument wavelength is accurately adjusted.

NOTE

This test is only a “secondary” check of the wavelength accuracy and does not necessarily indicate the absolute value for the DR/2000 Spectrophotometer which is factory set at ± 2 nm or better.

SECTION 5 TROUBLESHOOTING

5.1 Introduction

Correcting problem conditions with the DR/2000 Spectrophotometer in the field is limited to responding to the error messages presented in the display. Any other problems must be handled by a Hach technician at a service center. Refer to Section 7, Repair Service. **Do not attempt any servicing other than battery and lamp replacement. There are no other field-serviceable parts. Opening the instrument case will void the warranty.**

5.2 Error Messages

5.2.1 INCORRECT # Display

When the instrument displays:



it indicates that the reference number keyed in is not available for the operation expected. If a method number is being keyed in and the incorrect number message appears, it may be caused by a mis-keyed number or from attempting to enter a number in the configure series (800—900). When the instrument is in the configure mode, only numbers for configure options may be keyed in. *Refer to paragraph 3.4.* User-entered method numbers must range from 950 to 999. Entering a number outside the appropriate range for these procedures will result in the incorrect number message. When this error message is displayed, re-enter the proper number or scroll to the desired method or option.

5.2.2 OVER-RANGE Display

The display:



indicates that the displayed absorbance or concentration value exceeds the range of valid results. To indicate an erroneous negative result, the numeric display will show all zeros with a negative sign. Make sure the test procedure is followed correctly and rerun the test. Each Hach test has an upper absorbance value beyond which results are unreliable. If the test results exceed that limit by more than one-eighth of an absorbance unit, the over-range message appears and the test should be repeated.

5.2.3 LOW BATTERY Display

The instrument performs a battery test continuously. If the battery voltage of the rechargeable lead-acid battery falls to a level indicating less than ten percent battery life remaining, it will automatically warn the operator every five minutes by beeping once, displaying the message



for two seconds, beeping once again and then returning the display to normal. The warning will be repeated every five minutes. When the battery voltage falls below 7.2 volts, the instrument will switch to the momentary mode if it was not already in that mode. Then when the voltage drops below 7.0 volts, the instrument will turn on, display “Low Battery” and turn off. The batteries should be replaced, or if a rechargeable battery is installed, recharged as soon as possible to avoid losing test results or obtaining results that are not accurate. *Refer to paragraph 2.2.2 for battery installation instructions.*

The condition of the battery power source can be checked manually at any time by pressing SHIFT BATT. The battery voltage will be displayed in the large digits and a bar graph indication of the battery life will be displayed in the text section of the display. For example:

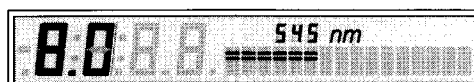

indicates a battery voltage of 8.0 volts and a battery life bar running half the width of the 16-character section for 50-percent life still remaining. The battery life indication, however, applies only to a lead-acid rechargeable battery. To cancel the battery condition display and return the instrument to its previous condition, press READ/ENTER.

5.2.4 LAMP OUT Display

If the monochromator lamp burns out or does not supply adequate light to provide a measurement, the display will read:



indicating that the lamp may need to be replaced. If the lamp will not light, it must be replaced. However, if the lamp is lit when the LAMP OUT ? message

appears, there are three possible conditions that could cause this message.

First, light reaching the photodetector is not adequate to make the measurement. The sample being measured may have too high an absorbance. This would be most likely to occur when operating at the low end of the wavelength range. Or, if a cell adapter is being used, it may be positioned in the cell holder improperly. Empty the cell compartment and determine if the message remains. If the absorbance was too high, sample dilution may be appropriate. Again the problem could be a deteriorating lamp that should be replaced.

Second, the lamp may be blackened to the extent that it will no longer supply sufficient light. Replacement of the lamp as described in paragraph 4.2.2 will correct the problem.

Third, the problem could be low lamp voltage. If a new lamp has been installed and the message remains in the display, this condition is likely. Because there is no gain adjustment the operator can make, contact a Hach service center for assistance.

5.2.5 MEMORY ERROR Display

When the display shows:

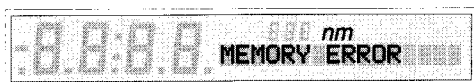

it indicates a probable condition where there is low supply voltage or an electrostatic discharge has occurred that interfered with operation of the instrument memory. The first step in determining the trouble is to disconnect power to the instrument. This means disconnecting the battery eliminator/charger cable from the POWER jack and, if a battery pack is installed, the battery cable inside the battery compartment must be disconnected. Now reconnect power, both the eliminator/charger cable and the battery cable if batteries are installed. If the memory error message is no longer displayed, the problem was transient and no permanent damage has occurred. The instrument will now operate properly.

If the message is displayed again after power is restored, additional investigation is necessary. If the instrument was operating on battery power only when the error message appeared, install fresh, fully charged batteries or use the battery eliminator/charger unit and perform the reset as described in paragraph 5.2.6, Restoring Factory Settings. The instrument should now return to normal operation.

If the instrument was operating on the battery eliminator/charger when the memory error message appeared, disconnect that unit and install batteries. If the instrument returns to normal operation, the

problem is due to low line voltage or the battery eliminator/charger unit malfunctioned.

If the memory error message occurs even with the batteries installed, perform the reset procedure in paragraph 5.2.6. If the instrument returns to normal operation after the reset, reconnect the battery eliminator/charger to recheck that unit. If the error message appears again, the problem is due to low line voltage or a faulty battery eliminator/charger.

A memory error display with a W requires attention by a trained service representative. Please contact the Hach service center or distributor serving you.

5.2.6 Restoring Factory Settings

This procedure allows the operator to erase all user-entered settings and calibrations to return to the original factory settings. It only applies to the three latest software configurations of the DR/2000 Spectrophotometer, v1.270, v2.0 and v2.2.

CAUTION

DO NOT perform this procedure if your software configuration number is v1.261. Monochromator calibration will be lost, requiring the instrument to be returned to the factory for recalibration.

To determine which software version you have, proceed as follows:

1. Press the POWER key to turn the instrument on.
2. Press the SHIFT and CONFIG keys.
3. Enter 888 and then press the READ/ENTER key. After three seconds, the software configuration number will appear in the display.

To perform the reset for v1.270, v2.0 and v2.2 software configurations, proceed as follows. **Be aware that all user-stored calibrations and settings will be lost.**

1. Press the POWER key to turn on the instrument.
2. Press the SHIFT and CONFIG keys.
3. Enter 888 and then press the READ/ENTER key. After three seconds, the software configuration number will be displayed.

CAUTION

If your software number is v1.261, do not continue.

4. Press the SHIFT and CONFIG keys again.
5. Enter 888 and then press READ/ENTER. Within two seconds, enter 357.
6. Turn the instrument off and back on. The factory settings will be restored and all user-entered methods and options will be erased.

SECTION 6 REPLACEMENT PARTS AND ACCESSORIES

Cat. No.	Description	Unit
43784-00	Adapter, AccuVac Vial	each
44799-00	Adapter Kit, COD Vial	each
44798-00	Adapter Kit, test tube, 13-mm	each
45168-00	Battery Eliminator/Charger	each
44866-00	Battery Holder, for 6 D cells	each
23432-67	Holmium Trichloride Powder Pillows	10
45218-00	Lamp Assembly Kit, includes Holmium Trichloride Powder Pillow	each
44800-88	Manual Set, includes: Instrument Manual Procedures Manual Three-Ring Binder	each
20950-00	Sample Cells, 1-inch, matched pair	each
21228-00	Zeroing Vial, AccuVac, w/cap	each

OPTIONAL ACCESSORIES

44895-00	Adapter, 1-cm cuvette	each
11494-54	Batteries, D size, pkg of 4	each
45185-00	Battery, rechargeable, 8 V	each
45193-00	Cable Assembly, printer	each
45215-00	Pour-Thru Sample Cell	each
45194-00	Recorder Output Phone Plug	each
16084-00	RS-232 Interface Phone Plug	each
45192-00	Printer, 115 V	each
13537-02	Sample Cell, 1-inch, unmatched pair	each
20951-00	Sample Cells, 1-cm, matched pair	each
24102-12	Sample Cells, Disposable, 1-inch Polystyrene, with caps	pkg/12
272-17	Water, deionized	3.78 L

SECTION 7 REPAIR SERVICE

For service assistance on your instrument, please contact the Hach Factory Service Center in Ames, Iowa, first for arrangements. Call toll-free **800-227-4224** and request Instrument Repair. If you are located in Canada, contact instead the Hach Sales & Service Canada Ltd., Winnipeg, Manitoba, for arrangements. The toll-free number is **800-665-7635**.

Hach Factory Service Center

Hach Company
100 Dayton Ave.
P.O. Box 907
Ames, Iowa 50010
(515)232-2533
FAX: (515)232-1276

Hach Canada Service Centre

Hach Sales & Service Canada Ltd.
1313 Border Street, Unit 34
Winnipeg, Manitoba
R3H 0X4
(204)632-5598
FAX: (204)694-5134

In Latin America, the Caribbean, the Far East or the Pacific Basin, please contact Hach Company, World Headquarters, P.O. Box 389, Loveland, Colorado 80539 U.S.A. Telephone (303)669-3050, Telex 160840, FAX (303)669-2932. Customers located in Europe, the Middle East or Near East, or in Africa, please contact Hach Europe, S.A./N.V., B.P. 229, B5000 Namur 1, Belgium. Telephone (32)(81)44.53.81, Telex (846)59027, FAX (32)(81)44.13.00.

SECTION 8 WARRANTY

Seller warrants equipment of its manufacture against defective materials or workmanship for a period of one year from date of shipment.

The liability of Seller under this warranty is limited, at Seller's option, solely to (1) repair, (2) replacement with equivalent Hach products, or (3) an appropriate credit adjustment not to exceed the original sales price of products returned to the Seller, provided that:

- a. Buyer promptly notifies Seller in writing on discovery of the defects, stating where applicable, the product type and serial numbers and fully describing the circumstances giving rise to the claim. Seller must receive such notification within the applicable warranty period in order for this warranty to apply.
- b. On receipt of written instructions from Seller, Buyer returns the equipment as instructed with transportation charges prepaid by the Buyer; and
- c. Seller's examination of such equipment discloses to its satisfaction that the defects have not resulted from any negligence, misuse, improper installation, accident or unauthorized repair or alteration by the Buyer. Seller's determination of the cause and nature of the failure of the equipment shall be final.

This warranty does not include limited life electrical components which deteriorate with age such as

batteries, lamps, photocells, electrodes, etc. In the case of equipment and accessories not manufactured by the Seller, but which are furnished with equipment of Seller's manufacture, Seller's liability is limited to whatever warranty is extended by the manufacturers thereof and transferable to the Buyer. **This warranty is applicable to the original Buyer only and shall be in lieu of and exclude all other warranties, expressed or implied, including, but not limited to, any implied warranty of merchantability or fitness. The foregoing shall constitute the sole and exclusive remedy of Buyer and the sole and exclusive liability of Seller, whether Buyer's claims shall be for breach of warranty or negligence. Seller neither assumes nor authorizes any person to assume for it any other obligation or liability in connection with the sale of the equipment. In no event shall Seller be liable for special, incidental or consequential damages.**

In no event shall Seller be liable for any damage resulting from improper handling or storage by Buyer.

If Seller finds that Buyer has returned the equipment without cause, Seller shall notify Buyer and return the equipment at Buyer's expense; in addition, Seller may, at its sole discretion, impose a charge for testing and examination of any equipment so returned.

USER-ENTERED CALIBRATIONS WORKSHEET

Test Name: _____ Test Method: _____ Date: _____ By: _____

METHOD #?

BEGIN USER PROGRAM MODE

Press SHIFT PROG METH.

Record the number displayed by the DR/2000:

0000

ENTER nm

ENTER THE WAVELENGTH

Key in the desired wavelength value and record it here:

Make corrections by pressing SHIFT CLEAR and re-entering the wavelength.

When you have correctly keyed the wavelength, press READ/ENTER.

000

DECIMAL? $\frac{1}{2}$ 00.00

POSITION THE DECIMAL POINT

Use the arrow keys to position the decimal point; record it here:

Press READ/ENTER to accept the decimal position.

0.000

UNITS? \updownarrow

SELECT THE UNIT OF MEASUREMENT

Use the arrow keys to select the desired unit, record it here:

To construct a unit of measure - accept blank field; go to next step.

Press READ/ENTER to accept the unit or blank selection.

SYMBOL? \updownarrow

CONSTRUCT THE CHEMICAL SYMBOL

Use the arrow keys to select the characters.

Press READ/ENTER to accept each character.

Make corrections with SHIFT LEFTARROW or SHIFT CLEAR.

When completed, record both unit and symbol here: \rightarrow

Press READ/ENTER to record the entire construction.

--	--	--	--	--	--	--	--	--	--	--	--	--	--	--	--	--	--	--	--	--

TIMER?

SET THE TIMERS (OPTIONAL)

To bypass entry of the optional timers, press READ/ENTER at the timer prompt.

If you wish to set timers, press SHIFT TIMER.

Record each timer you have set in the spaces below:

Enter all four digits including leading zeroes.

MM:SS TIMER 1 ?

MM:SS TIMER 3 ?

MM:SS TIMER 2 ?

MM:SS TIMER 4 ?

Press READ/ENTER when you have completed entering timer values.

ZERO SAMPLE

PERFORM A ZERO CALIBRATION

Insert a prepared blank sample and press ZERO.

0 STANDARD

SET THE ZERO CONCENTRATION POINT

Leave the blank sample in the well and press READ/ENTER.

Begin calculation of the concentration - absorbance zero point by pressing READ/ENTER.

Accept the zero point by pressing READ/ENTER

ENTER THE ABSORBANCE - CONCENTRATION DATA PAIRS.

Enter the concentration values of your prepared samples in the table below.

Follow the steps outlined for entry and calculation of each point.

To reject a calculated point - re-enter the concentration value.

1 STANDARD
2 STANDARD
3 STANDARD
4 STANDARD
5 STANDARD
6 STANDARD
7 STANDARD
8 STANDARD
9 STANDARD
10 STANDARD
11 STANDARD
12 STANDARD
13 STANDARD
14 STANDARD
15 STANDARD
16 STANDARD

Press to begin point	Enter & record Concentration	Press	Record Displayed Absorbance	Press to accept point
READ/ENTER		READ/ENTER		READ/ENTER
READ/ENTER		READ/ENTER		READ/ENTER
READ/ENTER		READ/ENTER		READ/ENTER
READ/ENTER		READ/ENTER		READ/ENTER
READ/ENTER		READ/ENTER		READ/ENTER
READ/ENTER		READ/ENTER		READ/ENTER
READ/ENTER		READ/ENTER		READ/ENTER
READ/ENTER		READ/ENTER		READ/ENTER
READ/ENTER		READ/ENTER		READ/ENTER
READ/ENTER		READ/ENTER		READ/ENTER
READ/ENTER		READ/ENTER		READ/ENTER
READ/ENTER		READ/ENTER		READ/ENTER
READ/ENTER		READ/ENTER		READ/ENTER
READ/ENTER		READ/ENTER		READ/ENTER
READ/ENTER		READ/ENTER		READ/ENTER
READ/ENTER		READ/ENTER		READ/ENTER

END USER PROGRAM MODE

When you have entered at least one point but not more than sixteen points

conclude the entry of data pairs by pressing SHIFT READ/ENTER

METHOD #?

SELECT A METHOD

At the method prompt you may now select your new method and perform a test.

SYSTEMS FOR ANALYSIS

AUTOMATIC ANALYZERS FOR

ALKALINITY
CALCIUM IN BRINE
CHELANT
CHLORINE
CHLORINE DIOXIDE
CONDUCTIVITY
COPPER
HARDNESS
HEXAVALENT CHROMIUM
HYDRAZINE
IRON
MANGANESE ⁺⁷
OZONE
pH
PHOSPHATE
POTASSIUM PERMANGANATE
SILICA

TURBIDIMETERS

pH AND CONDUCTIVITY METERS

PORTABLE INSTRUMENTS

PORTABLE TEST KITS

LABORATORY APPARATUS

REAGENTS



The Analytical Methods Company

HACH COMPANY WORLD HEADQUARTERS
P.O. Box 389
Loveland, CO 80539 USA
Phone: (303) 669-3050
Telex: 160840
FAX: (303) 669-2932

HACH COMPANY
P.O. Box 907
Ames, Iowa 50010 U.S.A.
Phone: (515) 232-2533
FAX: (515) 232-1276

HACH EUROPE S.A./N.V.
B.P. 229, B5000 Namur 1
Belgium
Phone: (32)(81)44.53.81
Telex: 846-59027
FAX: (32)(81)44.13.00

International distributors and sales agents in principal cities worldwide

MANUAL CHANGE NOTICE

Changes made to the optional Citizen Printer offered by Hach affect the instructions given in *paragraph 3.13 Using a Printer* in the DR/2000 Spectrophotometer Instrument Manual. Paragraph 3.13 (on page 22) should now read as follows. The change bar in the right hand margin indicates where the copy was changed.

3.13 Using a Printer

A permanent record of test results can be obtained by using the RS232 serial output to drive a printer. *Figure 17* provides a sample printout from the forty-column personal printer listed in the optional accessories in Section 6. When operating in the Momentary mode, a data string will be transmitted to the printer at the end of a test cycle after the READ-ENTER key is pressed to obtain the sample measurement. Operation in the Constant On mode provides a printout according to the frequency selected and does not require the READ-ENTER keystroke. Refer to *paragraph 3.7.3 Choosing Printer Output Frequency*.

Because the spectrophotometer programming for printer operation provides for a carriage return and line feed, printers with carriage returns (CR) must be configured to avoid the carriage return. In the case of the Citizen printer listed as an optional accessory in Section 6, it means setting switch and jumper positions on the Citizen 560RSL II printer board as follows. Set CN5 jumpers 1, 2 and 4 to open (to the right as viewed when reading CN5) and CN5 jumpers 3 and 5 to the shorted position (left). Set jumpers CN9, CN10 and CN11 to position "A". CN6, CN7 and CN8 should remain in position "B". Set all DSW1 switches **except** #2, #5 and #6 to ON. Refer to the drawing below and to "Setting of Preset Jumper" in the Citizen Printer manual.

