

STANDARD & HEAVY DUTY BRUSH CUTTER



MODEL SERIES

11-20 GPM

SOFBC60

SOFBC72

SBC60

SBC72

14-20 GPM

HDBCNS60-2

HDBCNS72-2

HDBCNS60-3

HDBCNS72-3

SAFETY RULES | OPERATING INSTRUCTIONS | MAINTENANCE PROCEDURES

Record product information below.

	
MODEL	<input type="text"/>
SERIAL	<input type="text"/>
	<input type="text"/>
www.cidattachments.com 336-859-2002	



PURCHASE DATE:
DEALER NAME:
ADDRESS:
PHONE NUMBER:

MODEL COMPARISON



The Standard Duty (Standard Low Flow) Brush Cutter

- 11-20 gpm
- 2-blades
- Stump Jumper (blade holder)
- 40HP right angle gear box
- closed and open front design (optional mesh grill available on open front)
- 3" cut capacity

Heavy Duty Open Front Brush Cutter

- 14-20 gpm
- 2 or 3 blades available
- fabricated blade holder
- 4" cut capacity
- RC100 gear box

Register this product at www.cidattachments.com.

 	<h2>NOTICE</h2> <p>This manual is part of the machine and should remain with the machine at all times.</p> <p>Store this manual in the document canister attached to this machine.</p>
--	--

	<h2>SCAN TO VIEW OWNER'S MANUAL</h2>  SDHDBC MAN01
STANDARD / HEAVY DUTY BRUSH CUTTER	

Copyright © 2022 Construction Implements Depot, Inc. All Rights Reserved. This manual may not be reproduced or copied, in part or in whole without written permission from CID, Inc.

SDHDBC MAN01 / FIRST EDITION / JANUARY 2022



TABLE OF CONTENTS

LETTER TO OWNER	6
------------------------------	---

SECTION 2 SAFETY INFORMATION

2.1 Introduction.....	8
2.2 Safety Symbols.....	8-10
2.3 Safety Decals.....	11-13
2.4 Skid Steer Tractor Requirements.....	14
2.5 General Safety Instructions.....	15

SECTION 3 OPERATING PROCEDURES

3.1 Unpacking Your Brush Cutter.....	17
3.2 How To Connect Brush Cutter Attachment.....	17-18
3.3 How To Start and Stop The Brush Cutter.....	19-20
3.4 First Time Use.....	20-21
3.5 Cutting Operations.....	22-24

SECTION 4 MAINTENANCE PROCEDURES

4.1 Maintenance Overview.....	26
4.2 Maintenance Schedule.....	27
4.3 Storage Tips.....	28
4.4 Blade Holder Removal.....	28-29
4.5 Blade Holder Installation.....	30
4.6 Blade Removal Procedures.....	30-31
4.7 Blade Installation Procedures.....	32
4.8 Shear Bolt Replacement.....	32
4.9 Gearbox Motor Maintenance.....	33-34
5.0 Torque Specification Table	34

SECTION 5 TROUBLESHOOTING

5.1 Troubleshooting Chart.....	36
--------------------------------	----

SECTION 6 SPECIFICATIONS

6.1 Specification Chart.....	38
------------------------------	----

SECTION 7 PARTS INFORMATION

7.1 Parts Assembly Diagrams.....	40-43
----------------------------------	-------

SECTION 8 WARRANTY INFORMATION

8.1 Limited Warranty Statement.....	45
8.2 Warranty Service Procedure.....	46

SAFETY ACKNOWLEDGEMENT FORMS	47-48
---	-------

MAINTENACE LOG	50
-----------------------------	----

THANK YOU

Dear Owner:

We appreciate your business and thank you for choosing Construction Implements Depot, Inc. as your provider of quality skid steer attachments. We are committed to providing you with a heavy duty product that will provide years of satisfaction and safe operation.

This manual will provide instructions on how to safely operate and maintain the Standard and Heavy Duty Brush Cutters. All users must read and understand this manual before operating this machine. Upon reading this manual, all users should sign the "Safety Acknowledgement Form" at the end of this manual. Store this manual in the document canister attached to this machine.

Please record your model and dealer information on the inside front cover. You will be asked to provide this information when ordering parts or requesting service. If you need more information on this product, contact your local dealer or visit www.cidattachments.com.

Sincerely,

The CID Team
Construction Implements Depot, Inc.



A decorative border made of red diagonal hatching surrounds the entire page content.

SECTION 2

SAFETY INFORMATION

2.1 Introduction

The following terms are used interchangeably throughout this manual.

Term	Alternate Terms Used
Standard Duty & Heavy Duty Brush Cutters	implement, attachment, product, machine, brush cutter, cutter
Skid Steer	skid steer loader, skid steer tractor, loader, prime mover
Operator	user, personnel

The **Standard and Heavy Duty Brush Cutters** are designed and manufactured with safety in mind. However, improper use and operator error can result in death or serious injury. It is important that you read and fully understand the safety instructions and operating procedures in this manual before operating this brush cutter. Accident prevention is a combination of good judgement, common sense, awareness and proper training!

BEFORE you operate this Brush Cutter:

1. **KNOW** how to safely operate your skid steer loader.
2. **READ** and **UNDERSTAND** the safety instructions and operating procedures contained in this manual.
3. **ACKNOWLEDGE** your understanding of all safety instructions presented in this manual by signing the "Safety Acknowledgement Form" at the end of this manual.

Although every effort has been made to ensure a safe product, every possible circumstance that could pose a potential hazard cannot be anticipated. The safety warnings in this manual and on this product, are therefore not all-inclusive.

In addition to the safety messages presented in this section, you must also read and understand the safety messages presented in the other sections of this manual.

2.2 Safety Symbols

This manual and decals on this machine use safety symbols, pictograms and color coded signal words to alert you to potential hazards that may cause death or severe injury if a safety instruction is ignored. Become familiar with the following symbols.



SAFETY ALERT SYMBOL - This symbol is used to alert you to potential personal injury hazards. Obey all safety messages that follow this symbol to avoid possible injury or death.

Hazard Classifications

Hazards are identified by the "Safety Alert Symbol" and followed by the signal word "DANGER", "WARNING", or "CAUTION".



Indicates an imminently hazardous situation which, if not avoided, will result in death or serious injury. This signal word is limited to the most extreme situations.



Indicates a potentially hazardous situation which, if not avoided, could result in death or serious injury.



Indicates a potentially hazardous situation which, if not avoided, may result in minor or moderate injury.



Indicates a situation which may cause damage to equipment or property. Messages are not related to personal injury.









Indicates specific safety-related instructions or procedures.

2.2 Safety Symbols Cont.

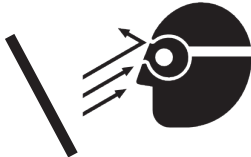
Safety Pictograms

Pictograms are graphic symbols meant to alert you of a potential hazard. Read and understand the hazard description for each of these symbols.

Pictogram	Description
	PINCH HAZARD: Keep clear of skid steer and brush cutter machine to prevent death or serious injury from pinching of moving parts.
	FLYING DEBRIS HAZARD: ONLY operate this machine using a skid steer that has a shatter proof cab to prevent death or serious injury from objects being thrown.
	OPERATING MANUAL: Operators must read and understand the safety instructions in the operating manual to prevent death or serious injury.
	EYE PROTECTION & CARDBOARD: Operators and Maintenance personnel must wear proper eye protection and use cardboard or wood to investigate hydraulic leaks to prevent death or serious injury from being injected with high pressure hydraulic fluid.
	HIGH PRESSURE FLUID INJECTION HAZARD: Operators and Maintenance personnel must not place fingers or hands directly over a hydraulic leak to prevent death or serious injury from being injected with high pressure hydraulic fluid.
	NO BYSTANDERS: DO NOT operate this machine near bystanders. Bystanders must stay back at least 300 feet from the machine to prevent death or injury from objects being thrown.
	CRUSH HAZARD: DO NOT place any part of the body under the machine or skid steer arms to prevent death or serious injury from being crushed .
	SAFETY CHAIN: Must be installed to prevent the mower deck from being raised more than 2 feet from ground level.

2.3 Safety Decals

The safety decals affixed to this machine are in place to keep you safe. DO NOT ignore these decals. Read and understand each decal's safety message. The following safety decals are affixed to this machine:

1



**SCAN
TO VIEW
OWNER'S
MANUAL**



STANDARD / HEAVY DUTY
BRUSH CUTTER

SDHDBC MAN01

2

! DANGER

 Do not place any part of body or limb under raised loader arms, bucket, or attachments at any time. To prevent serious injury or death from pinching: • Keep all persons and objects clear while any part of this machine is in motion.	 To prevent serious injury or death never operate in populated areas or where throw objects could injure persons or damage property. • Never operate rotary cutter with deck raised more than two (2) feet. • Safety chain must be installed before operating.
 HAZARD! FLYING DEBRIS STAY BACK TO PREVENT DEATH OR SERIOUS INJURY	 HIGH-PRESSURE FLUID HAZARD To prevent serious injury or death: • Relieve pressure on hydraulic system before servicing or disconnecting hoses. • Wear proper hand and eye protection when searching for leaks. Use wood or cardboard instead of hands. • Keep all components in good repair. • Grease all fittings daily.

**MUST READ
OPERATOR MANUAL**

3

WARNING

DO NOT EXCEED

**11-20
GPM**

WARNING

DO NOT EXCEED

**14-20
GPM**

4

DANGER STAY BACK

Figure 2.3 Safety Decal Locations



Figure 2.3 Safety Decal Locations Cont.

REF	DESCRIPTION	QTY
1	SCAN TO VIEW OPERATOR'S MANUAL QRS CODE STICKER	1
2	COMBO DANGER WARNING LABEL PINCH HAZARD, HIGH PRESSURE FLUID HAZARD, FLYING DEBRIS HAZARD, SAFETY CHAIN REQUIRED	1
3	WARNING DO NOT EXCEED GPM LABEL **WHEN ORDERING CHOOSE THE PROPER DECAL FOR YOUR MODEL	1
4	DANGER STAY BACK LABEL ** THERE ARE TWO DECALS left side front and right side front	2

Safety Instructions

- ⚠ Decals must be kept clean and legible at all times.
- ⚠ Operators must inspect the machine for safety decals.
- ⚠ Replace missing, worn or damaged decals immediately.
- ⚠ Use care when cleaning the machine. When using a hot pressure washer make sure water jet is not too close to the decal as this may cause the decal to peel.
- ⚠ When replacing parts, be sure safety decals are in place prior to using the machine.
- ⚠ Make sure metal surface is dry and free of dirt and grease before applying a new decal to this machine.
- ⚠ Contact your local dealer to order replacement decals.

2.4 Skid Steer Loader Requirements

CAUTION

Ensure your skid steer loader is in good operating condition. Follow the operating instructions found in the skid steer operator's manual. Failure to do so could result in minor or serious injury.



The Standard and Heavy Duty Brush Cutters should only be used on Skid Steer Loaders that meet the following requirements:

	STANDARD DUTY	HEAVY DUTY
Minimum Lift Capacity	1,200 lb	1,500 lb
Minimum Weight w/ Bucket Removed	5,500 lb	5,500 lb
Engine Horsepower	45	>50

Skid steer loaders must have impact resistant windshields and cab side windows.

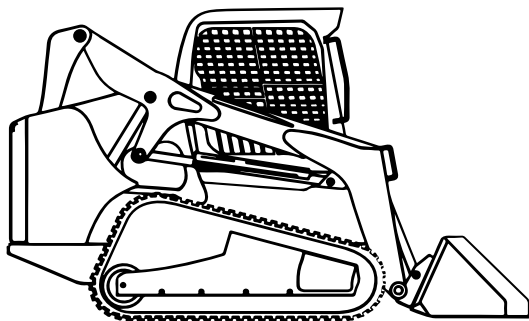

A skid steer equipped with tracks (COMPACT TRACK LOADER) will provide superior stability in this application.

2.5 General Safety Instructions

Below are general safety instructions that relate to the overall operation and maintenance of this machine. It is important that you read and understand each message to prevent serious injury or death.

- ⚠ ALWAYS watch for overhead power lines.
- ⚠ DO NOT place hands or feet under mower deck while blades are spinning.
- ⚠ NEVER operate this brush cutter when bystanders are within 300 feet of your work area. Flying debris could cause serious injury or death.
- ⚠ NEVER position your body or limbs under an unsupported cutter deck.
- ⚠ DO NOT allow this machine to contact buildings, utilities, large rocks or tree stumps or you may lose control of the skid steer loader.
- ⚠ NEVER use drugs or alcoholic beverages while operating or servicing this machine.
- ⚠ ALWAYS operate this attachment during daylight or well-lit areas.
- ⚠ Install this brush cutter on a skid steer loader equipped with a thermoplastic polycarbonate door panel and side panels only.
- ⚠ To prevent the skid steer loader and implement from rolling forward, stop the engine and set the parking brake when exiting the skid steer loader.
- ⚠ Inspect implement for missing hardware prior to using this machine.
- ⚠ DO NOT allow children to play on or around this equipment at any time. Store this implement in an area not frequented by children.
- ⚠ ALWAYS wear the proper personal protection equipment while operating or servicing this machine. NEVER operate or service this machine with bare feet, sandals, or other light footwear.
- ⚠ ALWAYS wear work gloves when handling cutter blades as they are often very sharp.
- ⚠ ALWAYS use eye protection while operating or servicing this machine.
- ⚠ DO NOT speed! Keep your driving speed between 2 and 5 mph.

SECTION 3

OPERATING PROCEDURES

3.1 Unpacking Your Brush Cutter

Your attachment arrives from the factory strapped to a wood pallet, and requires no final assembly. Use a pair of tin snips to remove the steel strapping.

! CAUTION

Shipping straps are under great tension, and could lash out uncontrollably when cut causing injuries to your body. Keep bystanders away and wear safety glasses and gloves while removing the straps.

3.2 How To Connect Brush Cutter Attachment

Consult your skid steer operator's manual for specific instructions on how to connect your brush cutter to your skid steer loader.

General Attachment Method

1. Ensure the hydraulic lines are clear from the front side of the brush cutter's attachment plate and that the levers on the skid steer quick attach mechanism are in the unlocked position.
2. Drive the skid steer to the attachment plate and hook the top edge of the skid steer quick attach mechanism under the lip of the brush cutter's attachment plate (see figure 3.2a below).
3. Slowly tilt the skid steer quick attach mechanism upward until the brush cutter attachment plate is flat against the skid steer quick attach mechanism (see figure 3.2a below).

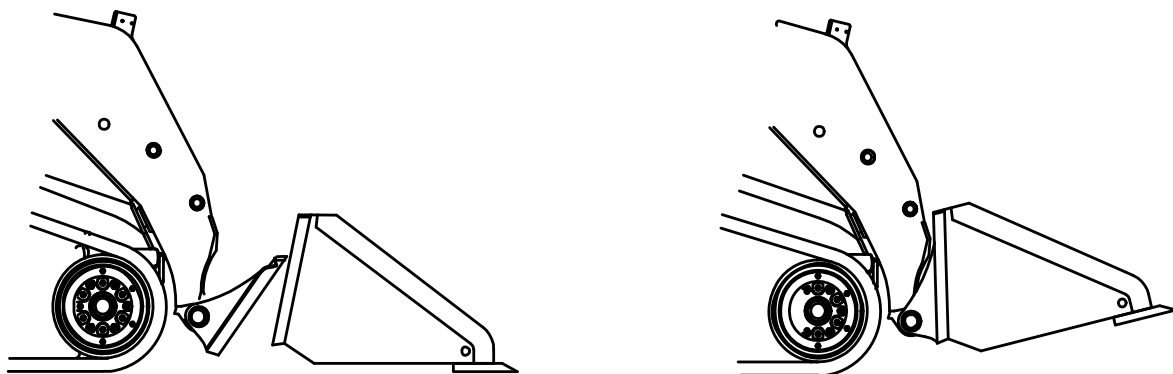

Figure 3.2a Quick Attach Mechanism Locked to Attachment

3.2 How To Connect Brush Cutter Attachment Cont.

4. Activate your skid steer's lever lock switch to lock the pins into the flange slots of the brush cutter's attachment plate. If your skid steer does not have this switch, manually lock the levers as shown in Figure 3.2b below.

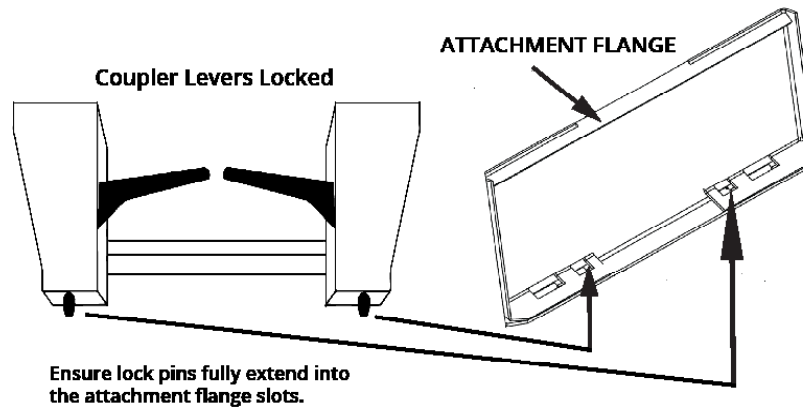

Figure 3.2b Quick Attach Mechanism Locked to Attachment Plate

NOTICE

To keep contaminants from entering the hydraulic system; wipe off any dirt or dust from the male or female hydraulic flat face couplers with a clean rag before attaching hoses.

5. Connect the hydraulic hoses to the auxiliary supply couplers located on your skid steer loader lift arm.

NOTICE

Check that hydraulic hoses are locked into the skid steer couplers before starting the cutter.

6. Attach the safety chain to a secure place on the skid steer unit to limit the height that the cutter can be raised.

⚠ CAUTION

DO NOT operate this machine if you (the operator) can see the cutter blade from the sitting position. If the operator can see the cutter blade, the back of the cutter is raised **TOO HIGH** lower the cutter deck to avoid debris from being thrown at the operator.

3.3 How To Start and Stop The Brush Cutter

Brush Cutter Controls

Your brush cutter is designed to run off the skid steer loaders auxiliary hydraulic system, and is activated and deactivated by a control in the operator's cab. The height and tilt functions of your brush cutter are operated with the control handles or pedals in the cab. Consult your skid steer operator's manual for precise instructions regarding these functions.

Hydraulic Flow Requirements

When operating the cutter, set the skid steer throttle at a speed that will produce the required flow. Your skid steer dealer can measure the flow available on your machine and recommend a throttle setting that is compatible with this attachment.

NOTICE

DO NOT exceed the designed flow rate (GPM) of your brush cutter. Check the specifications table on page 38 to see your specific model's max GPM setting.

Starting the Cutter

WARNING

Moving or engaging the cutter with bystanders in the area could result in Death or Serious Injury. Before engaging cutter hydraulics, always make sure the area is clear of bystanders.

1. Ensure attachment is secure and lock pins are fully engaged.
2. Ensure hydraulic hoses are locked to the skid steer's hydraulic couplers.
3. Set skid steer engine RPM to slightly above idle.
4. Activate skid steer auxiliary hydraulic circuit.
5. Once brush cutter is up to speed, increase skid steer engine to full throttle. Ensure cutter is running smoothly.

3.3 How To Start and Stop The Brush Cutter Cont.

NOTICE

If the brush cutter begins to vibrate while increasing the RPM's, deactivate the auxiliary hydraulic system and investigate the cause. Refer to the Troubleshooting Chart on page 36 of this manual.

Stopping the Cutter

1. Raise the cutter slightly and set skid steer's engine to idle.
2. Allow the cutter to slow down.
3. Shut off hydraulic flow to the brush cutter.

NOTICE

ALWAYS release the hydraulic system pressure from the auxiliary hydraulic circuit prior to removing the attachment or performing any hydraulic service work.

3.4 First Time Use Procedure

NOTICE

Before operating the brush cutter, check the skid steer's hydraulic oil level and add oil if necessary.

NOTICE

Verify that hydraulic hoses are securely locked to the skid steer hydraulic couplers before starting the brush cutter.

3.4 First Time Use Procedure Cont.

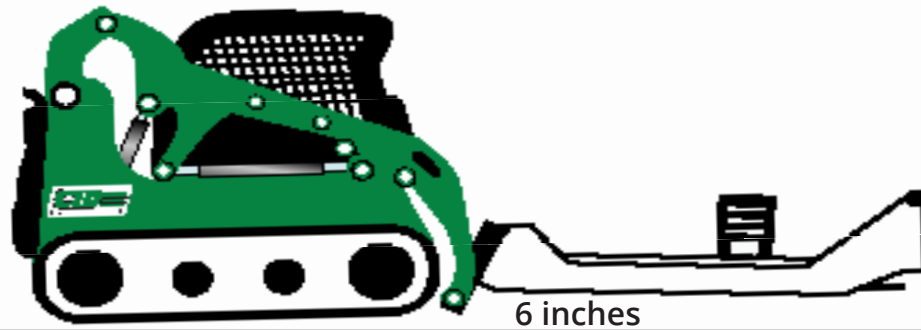

1. With the skid steer engine RPMs just above idle, activate the skid steer's auxiliary hydraulic system.
2. Allow the cutter to run for 30 seconds to purge air from the system, then turn off hydraulic flow to the brush cutter and allow it to come to a complete stop.
3. Lower the brush cutter to the ground, set parking brake, shut off the skid steer's engine and exit the operator's compartment.
4. Check the skid steer's hydraulic oil level, add oil if necessary.
5. Inspect the brush cutter hydraulic plumbing for any noticeable leaks. Fix leaks before continuing.

! WARNING

A small stream of oil from a pinhole leak could penetrate your skin if contacted. To avoid an accident that could result in Death or Serious Injury, never use your hand or other body parts in an attempt to locate a hydraulic leak.

6. Restart the skid steer, then set engine to slightly above idle.
7. Raise brush cutter off the ground and engage the hydraulic flow switch. Allow cutter to come up to speed before increasing engine speed.

3.5 Cutting Operations

General Operating Tips

- LEARN what the cutter head looks like in a level position when you are seated in the skid steer. Knowing what a level cutter head looks like will prevent you from damaging the cutter blades if you cut too close to the ground.
- SLOW down the skid steer if the engine “bogs” down or if the cutter speed is too slow because of too much load.
- LISTEN and FEEL for any strange vibrations or noises. If you feel a bad vibration when cutting, slow the skid steer down and see if the vibration stops. If not, stop the brush cutter and investigate the cause. Refer to the “Troubleshooting Chart” on page 36 of this manual.
- ALWAYS be aware of your surroundings and pay attention to what obstacles and terrain are in front of you.

CAUTION

Cutting tree branches with the cutter in an elevated position could result in Death or Serious Injury if the skid steer becomes unstable. Never raise the cutter more than a few feet off the ground when working on slopes or uneven terrain.

Adjusting Cutter Height & Level

Use the skid steer loader’s lift and tilt controls to adjust brush cutter height. Refer to your skid steer loader’s operator manual for instructions on these controls.

NOTICE

When cutting dense or heavy material, adjust the level of the cutter deck so the front of the cutter is approximately 1 inch lower than the back of the cutter. This will assist the processing of the material and will avoid material “balling” under the deck.

3.5 Cutting Operations Cont.

CAUTION

Use care when operating on uneven terrain or any type of sloped surface. Keep your cutter low to the ground when working in these conditions to avoid a roll over that could result in Minor or Serious Injury.

Before Cutting

1. ALWAYS inspect work area before starting the cutter. Locate and mark any utilities, steel posts, rocks or any other objects that could damage the brush cutter during operation. NEVER assume the work area is safe.
2. Operate the skid steer loader at a safe speed that will allow you to watch the area ahead of the cutter and loader.
3. Ensure skid steer engine RPMs are sufficient to deliver the required hydraulic flow to the brush cutter.

Cutting Ground Level Vegetation

Raise the rear of the brush cutter approximately 4 inches above ground level. The deck should be slightly sloping downward away from the operator.

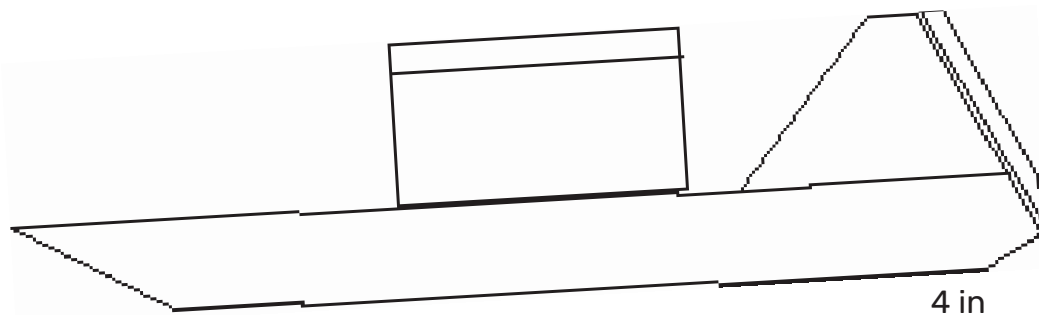

3.5 Cutting Operations Cont.

CAUTION

DO NOT operate the brush cutter if you can see the cutter blade while seated in the operator's seat. If the operator can see the cutter blade, the back of the cutter is raised **TOO HIGH**. Lower the cutter deck to avoid being hit by flying debris.

CAUTION

When cutting trees beware of the direction of fall to avoid the tree from crashing on to your skid steer loader.

Cutting Above Ground Level Vegetation

1. Tilt the front of the deck approximately 1 to 2 feet above ground level. **DO NOT** raise the rear of the deck.
2. Drive slowly into the vegetation and use the skid steer tilt function to push the vegetation forward. Allow the cutter blade to cut the vegetation.
3. Lower the front of the deck as you continue to mulch the vegetation.
4. Back drag the cutter to further minimize the size of the debris.

NOTICE

If the cutter speed slows down, reduce your travel speed and allow the cutter to reach the proper rotating speed. Mowing **TOO** fast in thick vegetation could result in "balling" of the material underneath the cutter deck resulting in a loss of cutting efficiency.

CAUTION

NEVER use your brush cutter to push, pull, lift or move any type of object or vehicle. **DO NOT** use this brush cutter to "push" down trees without using the cutter blades.

SECTION 4

MAINTENANCE PROCEDURES

4.1 Maintenance Overview

The maintenance procedures described in this manual should only be carried out by qualified mechanics who have been trained to repair this machine.







Some procedures require special tools and skills to complete. DO NOT attempt to repair or perform service work on this machine unless you have the skills and tools to do so. Contact your local dealer for maintenance and repair services.

NOTICE

Improper maintenance or modifications to the design or performance of this machine will void the warranty. ONLY use genuine CID replacement parts on this machine.

Safety Instructions

Obey the following safety instructions when servicing or repairing this machine.

-  Wear proper Personal Protective Equipment (PPE) while working on this machine, which may include safety glasses, hard hats, steel toe boots, gloves, etc.
-  Ensure all jack stands, lifts and hoists are in good working condition and have the rated load capacity to support the load.
-  If servicing is performed while the brush cutter is attached to the skid steer, turn engine off, set parking brake and chock wheels to prevent skid steer from moving.
-  Only perform service work in a well-lit area.
-  Allow the machine to cool down before servicing this machine. Hot oils can burn your skin.
-  NEVER work under an unsupported cutter deck.

4.2 Maintenance Schedule

This brush cutter attachment will provide years of dependable service if routine maintenance procedures are performed. The maintenance tasks listed below are based on normal operating conditions. More frequent maintenance may be necessary with intense use or when operating in adverse environmental conditions.

MAINTENANCE TASK	BEFORE EACH USE	WEEKLY	YEARLY
Check skid steer loader hydraulic fluid level. Add fluid as necessary.	X		
Check that all fasteners (nuts, bolts,, washers, pins, keepers) are in place. Tighten as necessary. (See Bolt Torque Table on page 34)	X		
Inspect and replace any worn, torn, or missing safety decals.	X		
Inspect hydraulic plumbing (hoses and connectors) for damage or leakage. Repair or replace hydraulic items as necessary.	X		
Check condition of cutter blades. Sharpen or replace as necessary.	X	X	X
Check oil level in gearbox motor. Add fluid as necessary.		X	
Change oil in gearbox motor. * Change oil after 50 hours of first time use, then every 1000 hrs or yearly.			X
Wash Brush Cutter		X	
Check brush cutter for major scratches and dings. Sand and repaint these areas to prevent rust damage. *Use a paint formulated for farm equipment which can be found at your local hardware store.			X

Maintenance Log

Document all maintenance and service activities performed on this brush cutter using the maintenance log included at the end of this manual.

4.3 Storage

Storage Tips

To get years of quality use out of your brush cutter, follow these tips when storing your brush cutter:

- Thoroughly wash then dry your brush cutter. Ensure brush cutter is free of debris, dirt, grime and grease.
- Store your brush cutter in a dry area such as in a shed or garage.
- Cover your brush cutter with a waterproof tarp if storing outside.

4.4 Blade Holder Removal

WARNING

To avoid an accident that could result in death or serious injury, **NEVER** place your body under an unsupported cutter deck when servicing this brush cutter.

ONLY service the brush cutter on stable, even terrain. **NEVER** park on sloped terrain to avoid being struck and killed or seriously injured by the unexpected rolling or movement of the skid steer.

NOTICE

ALWAYS release the hydraulic system pressure from the auxiliary hydraulic circuit prior to removing the blade holder.

1. Use the skid steer tilt function to place the attachment in a near vertical position.
2. Shutoff hydraulic flow to the brush cutter, and release pressure from the auxiliary hydraulic circuit.
3. Turn OFF skid steer engine, SET parking brake, and CHOCK skid steer tracks/tires to prevent skid steer from moving.
4. SECURE the front end of the cutter deck by using an overhead hoist and chain. If you are performing this procedure in the field, lean the cutter head against a large, stable tree that has a diameter of at least 10 inches (see **Figure 4.4a** next page).

4.4 Blade Holder Removal Cont.

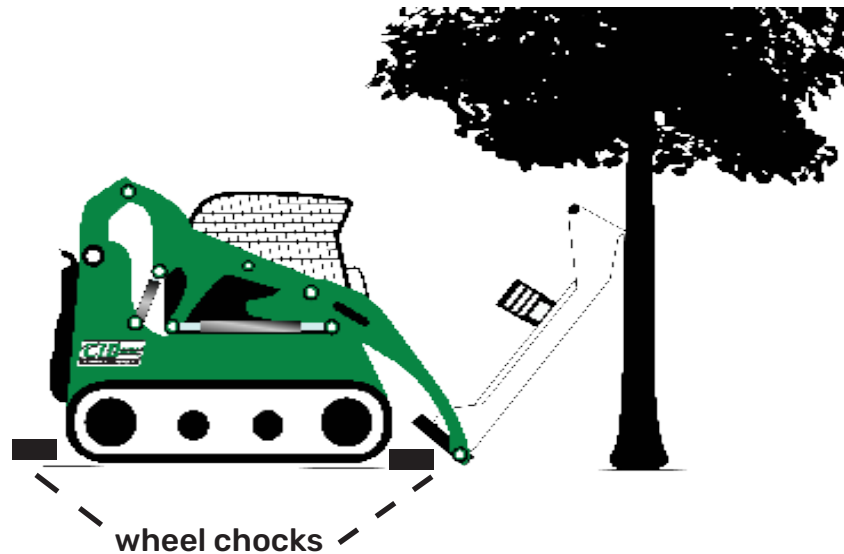

Figure 4.4a - Brush Cutter Deck Supported By Tree

Standard Duty Blade Holder Removal Procedure

A stump jumper type blade holder is used on the Standard Duty brush cutters.

Once the cutter deck is stable and secure:

REMOVE the dust cap, cotter pin and castle nut. *Note: If the stump jumper fails to separate, use a wedge breaker tool to separate the blade holder from the gearbox flange.*

Heavy Duty Blade Holder Removal Procedure

Once the cutter deck is stable and secure:

REMOVE the six bolts and six washers that secure the blade holder to the gearbox shaft. *Note: If the blade holder fails to separate, use a wedge breaker tool to separate the blade holder from the gear box flange.*

4.5 Blade Holder Installation

Standard Duty Brush Cutter Installation Procedure

NOTICE

Use a hoist, lift table or forklift to support the blade holder during installation.

1. Align the hole in the blade holder to the gearbox shaft and fully seat the holder onto the shaft.
2. Tap the blade holder with a rubber hammer to ensure full engagement. The blade holder must be properly aligned and seated on the gearbox shaft spline before proceeding to the next step.
3. Install castle nut, cotter pin and cap.

Heavy Duty Brush Cutter Installation Procedure

1. Align the hole in the blade holder to the gearbox shaft and fully seat the holder onto the shaft.
2. Tap the blade holder with a rubber hammer to ensure full engagement. The blade holder must be properly aligned and seated on the gearbox shaft spline before proceeding to the next step.
3. Install six bolts and six washers, then torque per the torque values on page 34.

4.6 Blade Removal

CAUTION

Cutter blades are sharp and could cut you if mishandled. **ALWAYS** wear protective gloves and footwear when handling cutter blades.

4.6 Blade Removal Cont.

NOTICE

This procedure requires special tools and skills. DO NOT attempt to remove or sharpen blades if you do not have the tools or skills. Take your brush cutter to your local dealer for blade services.

Standard Duty and Heavy Duty Blade Removal Procedure

1. Slowly rotate the blade holder until the blade attaching nut is aligned with the access hole in the cutter deck.
2. Insert a socket wrench through the access hole and remove the blade nut and lock washer. Let the blade fall to the floor.
3. Repeat these steps for the other blade(s).

Blade Sharpening Notes

1. Sharpen cutter blades with the appropriate tool.
2. Be careful not to overheat the blade steel causing the blade material to become brittle and prone to early failure.
3. Grind each blade to the similar shape and size so as to not create a set of mismatched blades.
4. ALWAYS sharpen or replace cutter blades as set.
5. NEVER mix and match used blades with new blades as they will cause the brush cutter to be unbalanced and result in a vibration that may cause damage to other

4.7 Blade Installation

Standard Duty and Heavy Duty Blade Installation Procedure

1. Insert the blade bolt up through the hole in the blade holder.
2. Install the lock washer and hand tighten the blade nut.
3. Torque the blade nut to 650 lb-ft.

4.8 Shear Bolt Replacement

NOTICE

Only use a grade 2 shear bolt or shear pin as a replacement part. Using a hardened bolt may result in damage to the gearbox motor.

1. Remove the motor cover.
2. Remove the damaged shear bolt from the gearbox input spline.
3. Align the holes in the input spline with the motor coupler and insert new shear bolt.
4. Install shear bolt nut, and torque to 38 lb-ft.



Figure 4.8a - Typical Shear Bolt and Nut

4.9 Gearbox Motor Maintenance

NOTICE

Service procedures for the gearbox motor require special tools and skills. Contact your local dealer for any gearbox repair work. **DO NOT** disassemble or modify the gearbox as this will void the warranty.

Checking Fluid Level

1. CHECK the oil level by removing the oil filler plug. The oil level should be at mid height of the input spline.
2. If low, add 85W-140 5EP grade gear oil. Check the oil level every week.

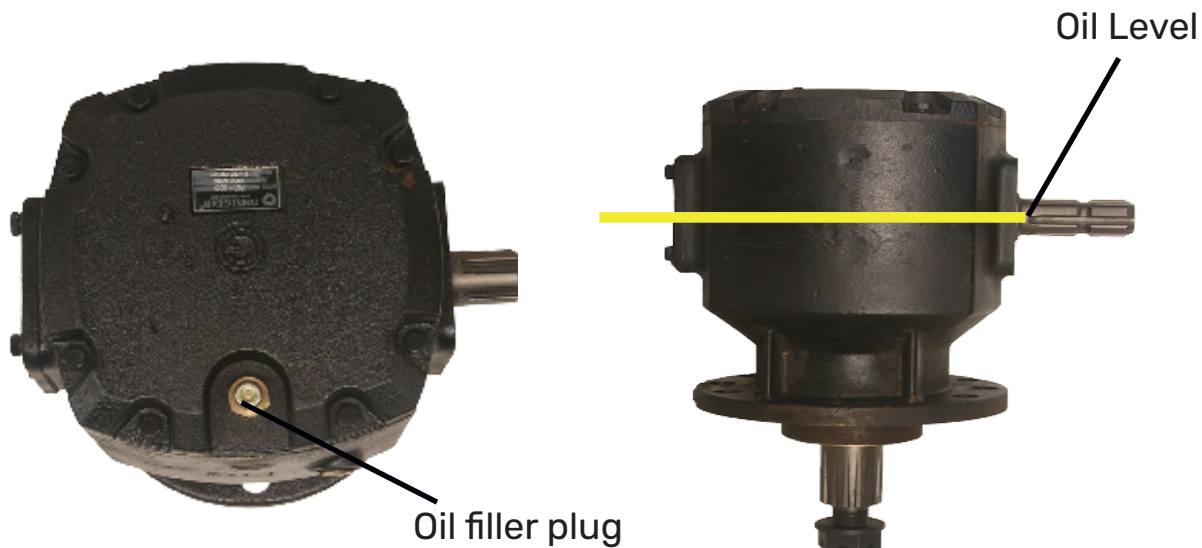

NOTICE

The initial oil should be changed after 50 hours of operation under load. Subsequent oil changes should take place after every 1000 hours of operation.

4.9 Gear Box Motor Maintenance Cont.

Gearbox Oil Change Procedure

1. Remove oil filler plug.
2. Insert one end of a discharge hose into the gearbox oil fill port and the other end into an approved waste oil container.
3. Pump the old oil from the gearbox motor.
4. Refill the gearbox with 85W-140 5EP grade gear oil to mid height of the input spline.
5. Reinstall oil filler plug.

5.0 Torque Specification Table

TORQUE VALUES SAE GRADE 8		
	DRY lb-ft	LUBRICATED lb-ft
1/4"	12	9
5/16"	24	18
3/8"	45	35
1/2"	110	80
3/4"	380	280
7/8"	600	450
1"	910	680

SECTION 5

TROUBLESHOOTING

5.1 Troubleshooting Chart

Problem	Cause	Resolution
Cutter bogs down	Deck is not properly leveled & material is balling under deck	Refer to leveling instructions found in this manual.
	Dull blades	Remove and sharpen blades.
	Ground speed too fast	Slow down ground speed.
	Cutter speed too slow	Raise engine RPMs or investigate other low oil flow problem
Vibration felt when running cutter	Missing, loose, damaged or unbalanced cutter blades	Replace blades with new or re-sharpened and equally balanced blades.
	Blade mount damaged	Replace blade mount
	Gearbox loose on deck	Tighten & torque gearbox mounting bolts. Replace bolts if they are damaged.
	Cutting height too low for cutting in sandy or rocky soils	Raise cutter height.
Blades get dull too quickly	Blades have contacted solid objects (rocks, steel pipes, etc.)	Clear cutting area of solid objects before hitting them, or raise the cutter height to clear exposed rock surfaces.
Blades breaking	Excessive shock loads	Avoid hitting solid objects (rock, steel pipes, large tree stumps, etc.).
Hydraulic oil level goes down during operation	Leak at cutter motor or other plumbing	Investigate & repair
	Leaks in skid steer hydraulic system	Investigate & repair
Blades do not spin when flow is activated	Shear bolt between motor and gearbox is sheared	Replace with proper shear bolt specified for this unit.
	Motor or gearbox failed	Disconnect the drive chain between motor & gearbox. If blade holder can be turned by hand, motor failure is suspect. Call your dealer for further recommendations.

SECTION 6

SPECIFICATIONS

6.1 Specifications Chart

STANDARD DUTY BRUSH CUTTER

MODEL NAME	MODEL #	WEIGHT (lb)	Min Skid Steer / CTL Lift Weight (lb) *	Min Skid Steer / CTL Lift Capacity (lb) *	Min Skid Steer / CTL Power	Gear Oil	GPM Requirement	Cut Capacity (inches)	Blade Config.	Deck Sizes (inches)
Standard duty open front brush cutter 60"	SOFBC60	839	5,500	1,200	45 HP	85W-140 5EP	11-20	3	2	3/16
Standard duty open front brush cutter 72"	SOFBC72	959	5,500	1,200	45 HP	85W-140 5EP	11-20	3	2	3/16
Standard duty brush cutter 60"	SBC60	959	5,500	1,200	45 HP	85W-140 5EP	11-20	3	2	3/16
Standard duty brush cutter 72"	SBC72	1,004	5,500	1,200	45 HP	85W-140 5EP	11-20	3	2	3/16

HEAVY DUTY BRUSH CUTTER

Heavy Duty Brush Cutter, 60" 2 blade	HDBCNS60-2	994	5,500	1,500	>50 HP	85W-140 5EP	14-20	4	2	3/16
Heavy Duty Brush Cutter, 72" 2 blade	HDBCNS72-2	1,390	5,500	1,500	>50 HP	85W-140 5EP	14-20	4	2	3/16
Heavy Duty Brush Cutter, 60" 3 blade	HDBCNS60-3	1,080	5,500	1,500	>50 HP	85W-140 5EP	14-20	4	3	3/16
Heavy Duty Brush Cutter, 72" 3 blade	HDBCNS72-3	1,650	5,500	1,500	>50 HP	85W-140 5EP	14-20	4	3	3/16

SECTION 7

PARTS INFORMATION

PARTS INFORMATION

Factory fresh parts specifically designed for your implement are readily available.

For hassle free service and to ensure you receive the correct parts for your implement, please provide your dealer with the following information:

Model Number	
Serial Number	
GPM Requirements	
Date of Owners Manual (Bottom Left Corner of Cover Page)	
Parts Diagram Page Number	
Part Description	
Reference #	
Quantity Desired	
Ship To Information	
Bill To / Payment Information	

Use Genuine Parts from Construction Implements Depot, Inc.

7.1 Parts Diagrams

Standard Duty

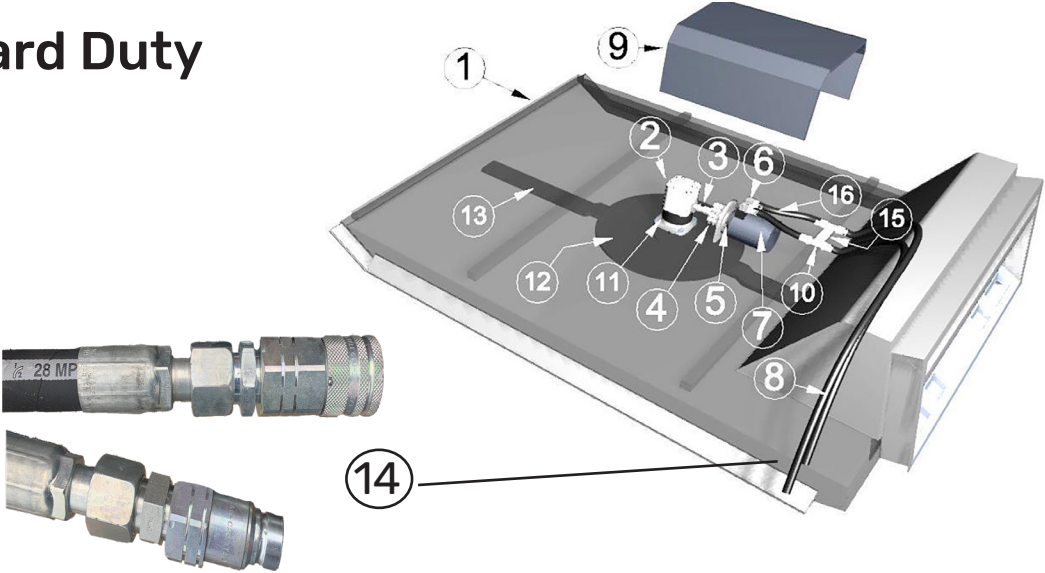

Ref. No	Part Description	Qty
1	Cutter Deck - Standard; open front (optional)	1
2	Gear Box	1
3	Shear Bolt & Nut	1
4	Chain & Sprocket Set	1
5	Bolt & Nut (secures motor to cutter mounting plate)	2
6	Elbow	2
7	Hydraulic Motor	1
8	Hose	2
9	Motor Cover	1
10	Tee	2
11	Bolt & Nut Set (Secures Gearbox to cutter deck)	3
12	Blade Holder (stump jumper)	1
	Castle Nut	1
	Protective Cap	1
13	Blade Set	1
	Blade Hardware Set	1
14	Quick Disconnect Set	1
15	One-way Check Valve	1
16	Hose	2

7.1 Parts Diagrams

Heavy Duty

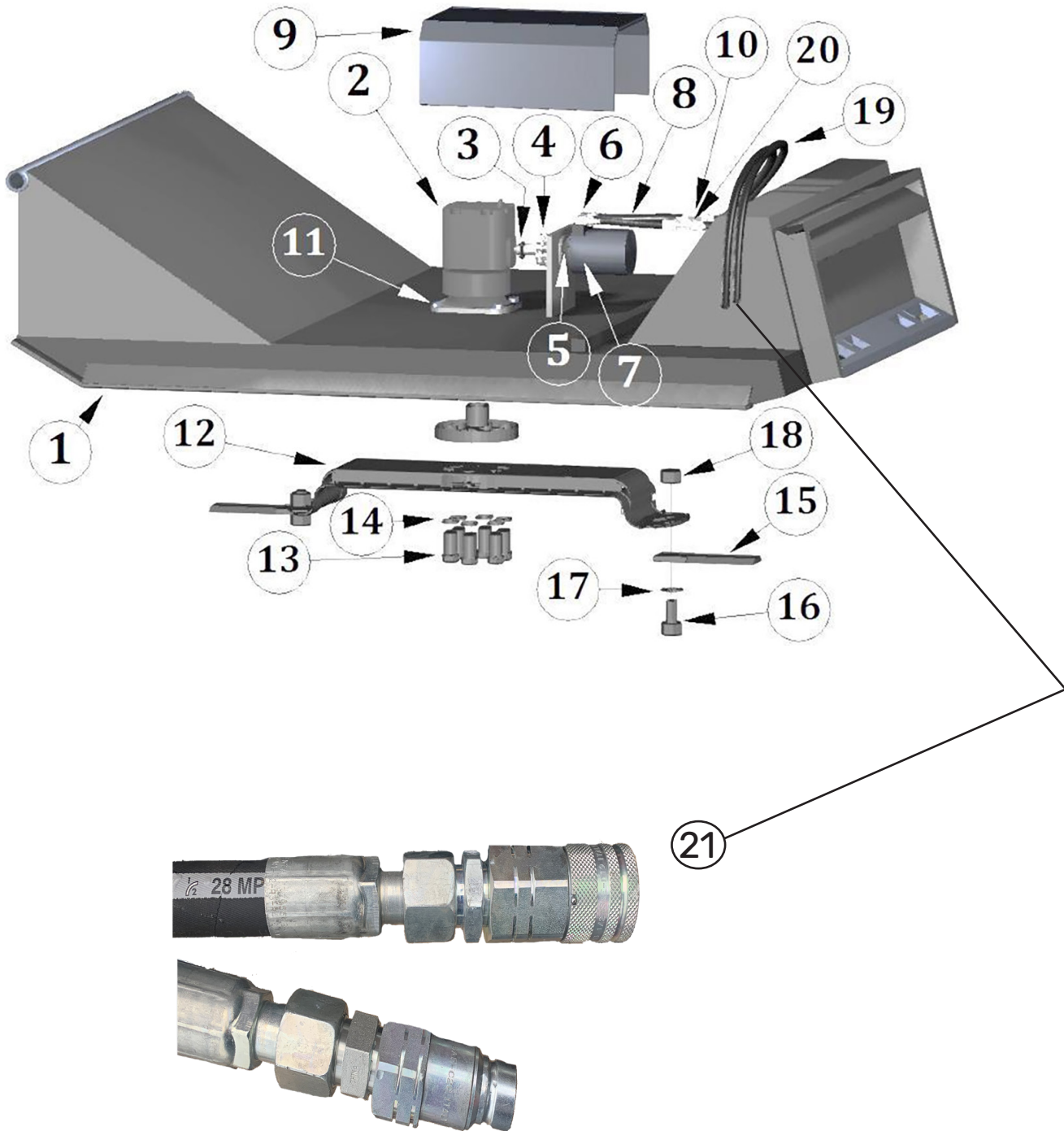

7.1 Parts Diagrams

Heavy Duty

Ref. No	Part Description	Qty
1	Cutter Deck Weldment	1
2	Gear Box	1
3	Shear Bolt & Nut	1
4	Chain & Sprocket Set	1
5	Bolt & Nut (secures the motor to the cutter mounting plate)	2
6	Elbow	2
7	Hydraulic Motor	1
8	Hose	2
9	Cover	1
10	Tee	2
11	Bolt & Nut Set (secures gearbox to cutter deck)	4
12	Blade Holder	1
13	Bolt	6
14	Washer	6
15	Blade	2
16	Bolt (Blade Retaining)	2
17	Spacer Washer	2
18	Nut	2
19	Hose (Tees to Quick Disconnect)	2
20	H-Valve (one way check)	1
21	Quick Disconnect Set	1

SECTION 8

WARRANTY INFORMATION

8.1 Warranty Information

Limited Warranty

Construction Implements Depot, Inc. products are warranted to be free from defects in workmanship or materials for a period of 12 months from the initial sale, lease or rental date.

Warranty Exclusions

This warranty does not cover normal wear items, including but not limited to: bearings, hoses, ground engaging parts such as teeth, blades, cutting edges, pilot bits, auger teeth and broom bristles. This warranty does not cover maintenance, service or adjustments. This warranty does not cover damage due to misuse, negligence, accidents, improper maintenance or modifications of this product. This warranty is void if any components have been disassembled, i.e., pumps, gear boxes or motors. Specially modified attachments built by CID X-treme Attachments to meet your customers' needs shall not be warranted by Construction Implement Depot, Inc. This warranty does not cover replacement parts not supplied by CID, Inc.

Warranty Statement

Our obligation under this Limited Warranty shall be solely limited to repairing or replacing any part (see non-covered items above) free of charge that, according to our judgment, show evidence of a defect in quality of workmanship or materials for the stated 12 month warranty period. All defective parts must be routed directly to CID, Inc. with freight or delivery charges to be prepaid. This limited warranty shall not be interpreted to render CID, Inc. liable for any injury or damage to persons, businesses or property of any kind nor expenses or losses incurred for labor, supplies, substitute machinery rental or for any other reason. Repair or replacement parts are subject to the supply conditions at the time of repair or replacements, which may directly affect our ability to obtain material and/or replacement parts. CID, Inc. reserves the right to make improvements in design or changes in specifications at any time without incurring any obligations to owners of previously purchased products. No one but CID, Inc. is allowed to alter, modify or enlarge this warranty nor the exclusions, limitations and reservation at any time.

8.2 Warranty Service

Warranty Service Procedure

RGA (Returning Goods Authorization) Policy:

If repairs are required, CID must obtain an RGA number from the manufacturer of the defective part and proof of purchase. RGA and services are rendered by CID only. Any responsibility of shipping costs on any item returned for repair is at the discretion of CID. All returned parts must have:

1. A legible RGA number written on the outside of the package.
2. A Service Request Form.
3. The defective part.

RGA numbers are only valid for 30 days from the date of issue. All shipped replacement parts will require a PO number from the original CID Customer. If the defective part is rendered non-warranty, the PO number will be invoiced for the replacement. Should you have any problems with your attachment, please follow the following procedures to obtain service.

1. Call the Warranty Department at (336) 859-2002 ext 215. You will need to provide the model and serial number of the defective item(s), a description of the problem and have photographs available.
2. Upon a warranted issue, visit www.cidattachments.com, click on the warranty tab, and fill in the warranty information. CID will retain an RGA number from the manufacturer of the defective part. If all the information above is fulfilled the manufacturer will issue an RGA number.
3. Obtain a PO number from the original CID customer. PO numbers will be invoiced in the event the defective part(s) is un-warranted
4. CID will ship a replacement part with a Service Request Form and RGA #. There will be a call tag with the Manufacturer's address and instructions for returning the defective part.
5. Once the defective part is warranted by the manufacturer, CID will be issued a credit and the PO number will be void.
6. In the event the manufacturer renders that the attachment be returned to CID for repair, CID will make arrangements for pickup and return. Repairs will be performed by CID qualified technicians. Non-warranted issues will be discussed and repairs will be performed upon agreement of the owner, and payment for parts and labor will be issued.

SAFETY ACKNOWLEDGEMENT FORM

ATTN ALL OPERATORS: Print your name, sign and date in the boxes below to acknowledge that you have read and fully understand the safety instructions presented in this manual, and have been trained on how to safely operate this attachment.

OPERATOR NAME	SIGNATURE	DATE

SAFETY ACKNOWLEDGEMENT FORM

ATTENTION ALL OPERATORS: Print your name, sign and date in the boxes below to acknowledge that you have read and fully understand the safety instructions presented in this manual, and have been trained on how to safely operate this attachment.

OPERATOR NAME	SIGNATURE	DATE

SECTION 9

MAINTENANCE LOG

MAINTENANCE LOG

Use this log sheet to document all routine maintenance and repair services performed on this machine.

DESCRIPTION OF MAINTENANCE	SERVICED BY	DATE



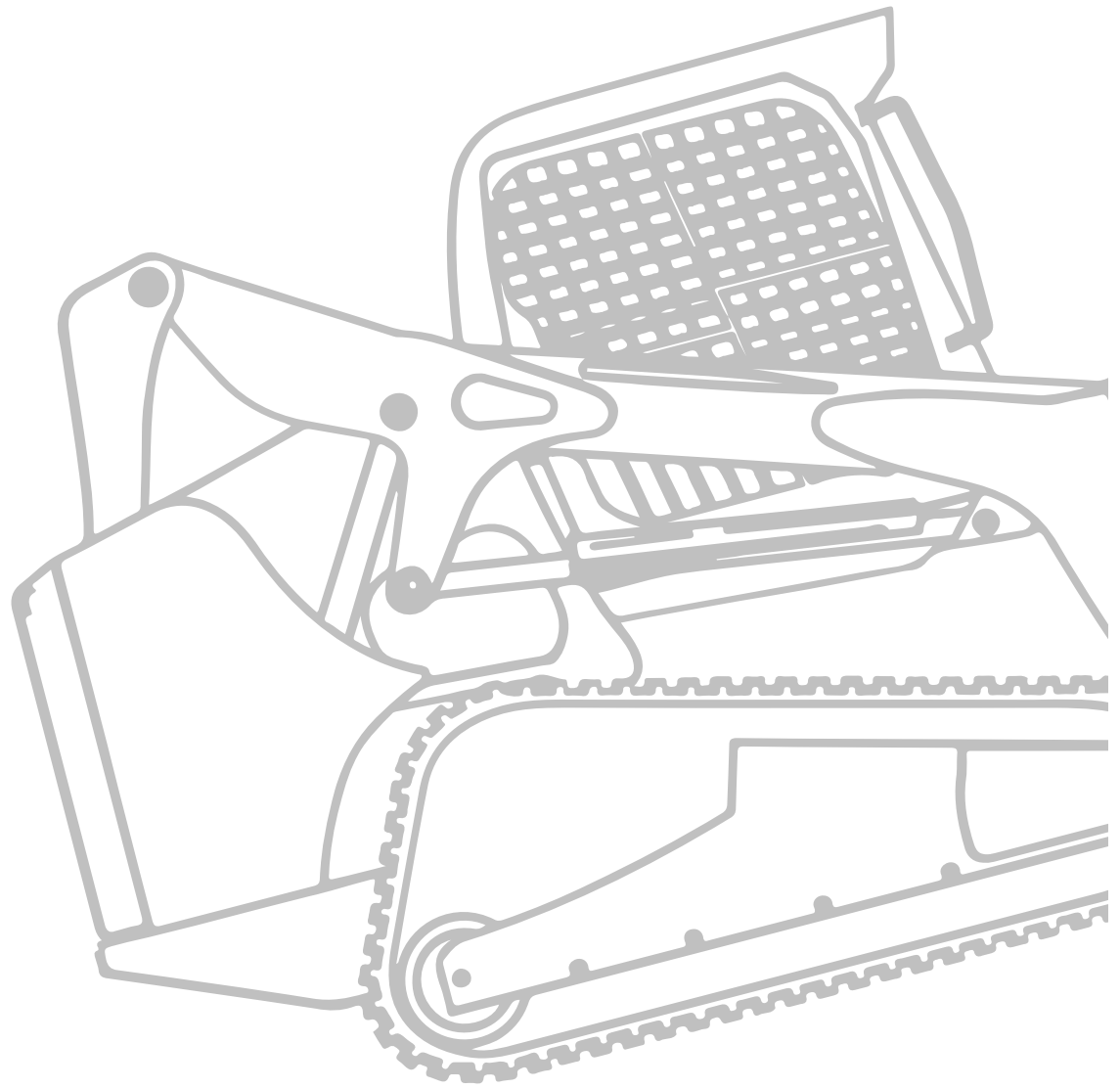
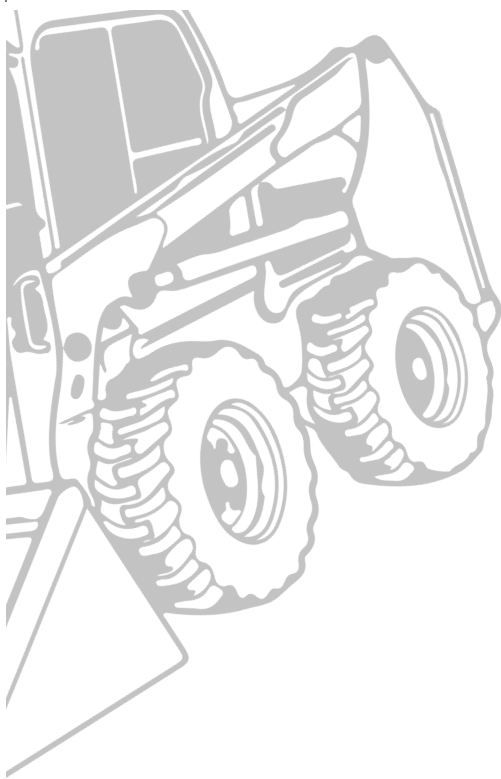

1248 N. Main Street | P.O. Box 1230 | Denton, NC 27239

Phone: 336.859.2002 | Fax: 336.859.0800

sales@cidattachments.com

www.cidattachments.com