



X-treme Tree Shears



Owner's/Operator's Manual



WARNING

For safe operation, read these rules and instructions carefully to avoid accidents that could result in Death or Serious Injury.

TO THE OWNER/OPERATOR OF THIS IMPLEMENT

Please read this manual "before" unpacking or using this implement for the first time. This manual provides you with the necessary instructions to safely install and use your purchase. Do not let other people use this attachment without first being instructed how to safely use it.



Construction Implements Depot, Inc

1248 N. Main Street

Denton, NC 27239

(336) 859-2002

Save this manual for future reference!

Thank You

Our sincere appreciation to you on the purchase of a quality X-treme Tree Shear designed and manufactured in the USA by Construction Implements Depot, Incorporated. Product experience of a combined 30 years is the cornerstone of our company, and our goal is to provide you with a heavy duty product that will give you years of satisfaction and operation.

Our record of successful and satisfied customers is evidence of the concern for quality and designed strength that we place into each and every product we build.

As this manual expresses the need for safe operation of your acquisition from Construction Implements Depot, Inc, it is important that you and all operators of this implement become familiar with the operation, maintenance and safety instructions found in this manual, as well as in the manual that accompanied the skid steer machine that will power this attachment. Add some common sense to the items mentioned in these manuals as the recipe for safe operation.

We invite you to look at more innovative products on our web site:
<http://www.cidattachments.com> or if in the area stop and visit our modern manufacturing facilities located in Denton, NC.

Sincerely,
Management & Employees
Construction Implements Depot, Inc.

Information

Record product information here for future reference.

Model (✓) X-treme Non-Rotating Shear _____
X-treme Rotating Shear:
Manual _____
Hydraulic _____
S/N or MFG. Date _____
Dealer Name _____
Dealer Phone ____ - ____ - _____
Date of Purchase __/__/____

Table of Contents

Thank You	2
Information.....	2
Orientation	3
Importance of Safety	3
Operator Safety Training Tips.....	4
Skid Steer Requirements	5
Unpacking Your Shipment	5
Using Your Implement	5
Connecting Shear to Skid Steer	5
Pre-Operation Walk-around Inspection.....	6
Shear Boom Controls.....	6
Engaging Shear the First Time	7
Stopping the Shear	7
Getting Familiar with the Attachment	7
Adjusting Shear Height & Level	8
Rotating the Shear Head	8
Starting the Job	8
Cutting Tips	9
Shear Rotation.....	10
Maintaining your Attachment	10
Modifications	10
Before Every Use	10
Every Week	10
After Every Season	11
Blade Sharpening	11
Blade Removal & Installation	11
Hydraulic System.....	12
Hardware Torque	12
Parts.....	13
Non-Rotating Tree Shear Parts.....	13
Rotating Tree Shear.....	15
Decals	16

Troubleshooting	17
Specifications.....	18
Hydraulic/Electrical Drawing	19
Limited Warranty.....	20

Orientation

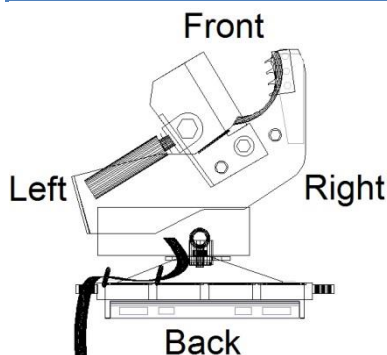

*Serial Number Plate is Located on Top of
Mounting Plate*

Importance of Safety

Accidents can be very costly to human life and property. As the operator is the #1 safety device on all types of vehicles or equipment, it is important that the operator read, learn and know all safety recommendations for this product. The user is responsible to his family, friends and co-workers to operate in a safe manner. Ensure that everyone who operates or assists in the operation or maintenance of this product read and understand all the elements required to safely operate this piece of equipment.

This attachment has moving parts that include additional dangers.

Throughout this manual you will find safety notes which are very important to read and understand before operating this piece of equipment. These classifications alert you to

situations that could be harmful to you or bystanders. When you see these alerts in the manual, carefully read and follow all instructions and also protect other workers from the same danger.

 **DANGER** Will result in Death or Serious Injury.

 **WARNING** Could result in Death or Serious Injury.

 **CAUTION** Could result in Minor or Serious Injury.

 **NOTICE** Not related to Personal Injury.

Operator Safety Training Tips

It is the responsibility of the operator using this attachment to be acquainted with the safe operation. In addition to reading this manual, it is important that the operator read the skid steer's operation manual and follow its manufacturer's recommendations!

 Before lifting or lowering the shear, make sure the area is clear of bystanders or objects.

 Machinery parts sometimes have sharp edges. Wear work gloves when moving parts. Always use caution around the shear blade as it may have a sharp edge.

 Never use drugs or alcoholic drinks when operating or servicing this piece of equipment.

 Always wear the proper personal protection equipment when servicing or operating this piece of equipment. Never service or operate this

attachment with bare feet, sandals, or other light footwear.

 Always use eye protection during operation. Mount this attachment on a skid steer equipped with thermoplastic polycarbonate door panel and side panels.

 Speed Kills! Operate this implement at a safe working speed. When transporting the implement, keep a safe speed to avoid losing control of the attachment or prime mover.

 Keep proper clearance between the implement and objects (utilities, tree stumps, large rocks, buildings, etc.). Contacting these objects with the implement or prime mover could cause a loss of control or damage to the implement or property.

 Never attempt to operate this attachment from anywhere but when seated in the prime mover's operators seat.

 Stop the engine on the skid steer and set the brake to avoid the implement rolling forward or backwards while you are exiting the prime mover.

 Store this implement in an area not frequented by children.

 Allow no riders on this attachment. Keep all bystanders clear of attachment during operation.

 Always replace worn, torn or missing safety decals before operating.

 Never operate the shear when bystanders are within 100 feet (30 m) of the work area.

 Cut only during daylight or well-lit artificial light.

Skid Steer Requirements

Your X-treme Tree Shear should only be used on a skid steer with a lift capacity of at least 1800 lbs. and with a weight of at least 6500# with the bucket removed. A skid steer equipped with tracks will provide superior stability in this application.

To protect the operator from any flying debris, it is important that the skid steer should be equipped with a thermoplastic polycarbonate windshield or similar material, and similar protection on the sides of the operator's cab.

 **CAUTION** *Make sure your skid steer is in good working condition. Follow the operating instructions found in the manual that accompanied your skid steer. Failure to do so could result in Minor or Serious Injury.*

Unpacking Your Shipment

Your attachment arrives from the factory banded to a wooden pallet, and requires no final assembly before use.

 **CAUTION** *Careless removal of the shipping bands that secure the implement to the pallet could result in Minor or Serious Injury. Clear the area of all bystanders and stand to the side when cutting the*

bands with a pair of sheet metal shears.

Using Your Implement

Connecting Shear to Skid Steer

 **DANGER** *Never enter the area underneath the coupler or any part of the attachment when it is in the raised position to avoid an accident that will result in Death or Serious Injury.*

Verify that the hydraulic hoses are clear from the front of the attaching plate on the attachment and that the mounting plate is free from dirt and debris. When clear, move the skid steer to proximity of attachment plate. Tilt skid steer coupler forward to align coupling point with the upper part on the back of the attachment plate and raise the coupler slightly.

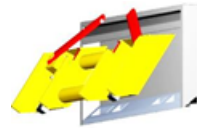

Connecting Coupler to Attachment

When the top edge of the coupler is seated in the top part of the coupler plate, roll the skid steer tilt function back until the attaching plate is flat against the skid steer coupler. Lock down the coupler levers. Note: If your skid steer is equipped with a hydraulically operated coupler, activate the coupler lock at this time. Shut the Skid steer's engine off and release the pressure in the auxiliary circuit.

○

PLEASE NOTE:
Attachment and Machine-side Couplings must be **FREE OF DEBRIS BEFORE INSTALLING.**
Failure to comply will void warranty.

NOTICE *Wipe off any dirt or dust from the male or female hydraulic flat-face couplers with a clean rag before attaching hoses to keep contaminants from entering the hydraulic system.*

Connect the attachment hydraulic hoses to the auxiliary supply couplers located on your skid steer loader lift arm.

If your shear is equipped with the hydraulic rotating shear, attach the electrical harness to the appropriate 12 volt source on the skid steer and place the switch in the operator’s compartment. There is a magnet on the back of the switch box to allow you to place the switch at a location inside the cab of your choice.



Connect Wire Harness on Model with Hydraulic Rotation (only)

Check the surrounding area for bystanders and clear them before starting the skid steer or attachment.

Before operating the attachment, always visually inspect and verify that the coupler lock pins are fully engaged through the latch slots on the attachment plate.

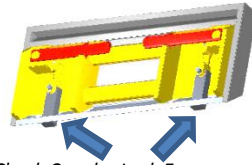

*Check Coupler Lock Engagement
Pre-Operation Walk-around Inspection*

Before every use, it is important to perform a short inspection and certain maintenance on your tree shear.

	Item
✓	Check that all shields and guards are in place.
✓	Look for loose bolts and tighten them if necessary.
✓	Check that all safety decals are in place and can be read. Replace them if necessary.
✓	Check that blade is in good condition. Sharpen, if necessary.
✓	Take care of our environment. Repair any hydraulic leaks.

Shear Boom Controls

Your X-treme Tree Shear is designed to operate by the skid steer’s auxiliary hydraulic system, and is operated by a control in the operator’s cab. Consult your skid steer operator’s manual for precise instructions on how to activate and deactivate the auxiliary circuit.

Height and tilt functions of the tree shear are operated with the control handles or pedals in the cab. Consult your skid steer operator's manual for precise instructions regarding these functions.

Engaging Shear the First Time

NOTICE *If this is your initial startup with this attachment on this machine, check the skid steer's hydraulic oil level and add oil, if necessary, before and after doing steps 1- 3 below.*

After starting the skid steer, lift the attachment 6" (152mm) off the ground surface:

1. With the skid steer engine RPMs just above idle, slowly engage the auxiliary hydraulic to open the shear arm. Move the auxiliary control pedal, lever or switch in the opposite directions to open & close the shear. Repeat this three times.
2. If your shear is equipped with the hydraulically operated rotation feature, operate that function in both directions three times also.
3. Lower the tree shear attachment to the ground and shut off the skid steer's engine and exit the operator's compartment.
4. Check the skid steers hydraulic oil level, and add oil if necessary.
5. Inspect the tree shear's hydraulic plumbing for any noticeable leaks. Correct these leaks before continuing.

Stopping the Shear

The shear blade quits moving when the auxiliary control is neutralized. When you are done cutting, close the shear to avoid someone walking into the blade during servicing or walk-around inspection.

Getting Familiar with the Attachment

⚠ DANGER *Never operate the shear when bystanders are within 100' (30 m) of your work area. Flying & falling debris could result in Death or Serious Injury.*

⚠ CAUTION *Be cautious when operating on un-level ground surfaces. A machine roll over could result in Minor or Serious Injury. Always wear your seat belt when operating this type of machinery.*

Before starting the skid steer engine with this shear attached, make sure you are knowledgeable and comfortable with the operation of the tree shear controls as outlined in the previous and following sections of this manual.

To begin with, learn what the shear head looks like in a level cutting position when you are seated in the skid steer. Knowing what a level shear head looks like will help you avoid damage to the cutting blade by cutting too close to the ground surface.

Always be aware of your surroundings. While watching the shear, also pay attention to what obstacles or terrain are in front of the shear and prime mover's wheels.

⚠ CAUTION *Cutting tree branches with the shear in an*

elevated position could result in Death or Serious Injury if the skid steer becomes unstable. Never raise the shear more a few feet off the ground when working on slopes or uneven terrain.

Adjusting Shear Height & Level

Use the skid steer loader lift to adjust the elevation of the shear. The fore & aft leveling can be accomplished by using the skid steer's attachment tilt cylinders.

Rotating the Shear Head

Manual Models: You will need a coworker to assist in rotating the shear head.

1. With your coworker a safe distance from the attachment, raise the attachment about 18" (450 mm) off the ground. Shut off the skid steer engine and remove your hands from the skid steer controls.
2. Motion to your coworker to stand on the right side of the shear and pull the safety pin and lock pin from the top of the shear (Reference arrows 1 & 2 in the next picture).
3. When both the safety and lock pin has been pulled, the shear head needs to be rotated 90° (counterclockwise) until the pin bracket aligns with the other lock bushing on the side of the frame (reference arrow 3 in the following picture. Insert the lock pin & safety pin.
4. Wait until your coworker has moved out of the immediate area before starting the skid steer and resuming your tree shearing work.
5. To return shear head to the regular tree shearing position,

repeat above procedure in reverse.

Hydraulic Rotating Models: Close the shear and activate the rotation switch. Reverse switch direction to rotate the shear head back to the horizontal shearing position.



Steps to Rotate Shear Head

Starting the Job

⚠ DANGER ***Never cut trees in the proximity of any above-ground utilities. Felling a tree on electrical power lines and making contact with your skid steer or bystanders even at an assumed safe distance will result in Death or Serious Injury.***

Never fell trees in the direction of overhead power or communication lines. Never shear a tree unless it is twice the tree's height away from the overhead lines.

⚠ WARNING ***Moving or engaging the tree shear with bystanders in the area could result in Death or Serious Injury. Before engaging the tree shear hydraulics, always make sure the area is clear of bystanders.***

Before cutting your first tree, always visually inspect the surrounding area for any objects that could be damaged if a tree fell on it. This shear will usually fall the tree to the right side of the

shear, but in certain conditions (strong winds, leaning tree), the tree might not always go in the intended direction.

Tree top branches could entangle with other tree branches and alter the course of the tree fall.

To avoid a tree that falls in an unexpected direction, always be ready to move the skid steer quickly away from the impending danger.

⚠ WARNING Exposure to crystalline silica dust along with other hazardous dusts may cause serious or

fatal respiratory disease. It is recommended to use dust suppression, dust collection and if necessary personal protective equipment during the operation of any attachment that may cause a high level of dust.

Determine a safe cutting pattern before the start of the cut. If trees are going to be dragged with a skidder to a landing, plan your cut so the sheared ends of the trees are facing towards the landing or access path.

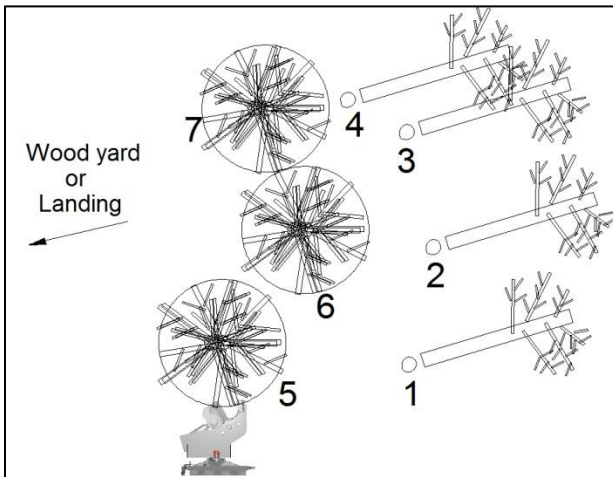

Example of Tree Cutting Pattern Plan (Overhead View)

Cutting Tips

⚠ CAUTION Never operate this attachment when bystanders are in proximity of the work area that could result in Minor or Serious Injury from flying debris, falling trees or branches.

⚠ CAUTION Use care when operating on uneven terrain or any type of sloped surface. Keep your shear low to the ground when working in these conditions to avoid a roll over that could result in Minor or Serious Injury.

1. Operate at a safe pace that will allow you to watch the area around the shear & loader.
2. Your X-treme Tree Shear is capable of cutting trees and other vegetation of up to 12" (305mm) in diameter. Learn and realize which way the tree is likely to fall so it does not end up crashing onto you in the skid steer.
3. Hardwood trees of up to 12" may require a second "bite" and shear action to penetrate through the tree. Locust, Osage Orange,

- Hickory, Oak & Ironwood may require a second shear action.
4. Never use your shear to push, pull, lift or move any type of object or vehicle. Do not use this attachment to “push” down trees without the shear being used.
 5. Your attachment is not to be used as a dozer blade in any direction.
 6. Your shear was not designed as a stump-puller; therefore do not use it as one.
 7. Clean out any limbs or trash that may accumulate around the shear’s cylinder or pivot areas.
 8. **Never** shear trees from the lower side of a hill or sloped area. Reposition your skid steer and attachment to a location above the ground-line elevation of the tree being cut.
 9. **Never** exit the skid steer cab with the shear in the raise position. Never walk or lay under the attachment in a raised position, or allow any bystander to do so.

Shear Rotation

(Manual or Hydraulic Rotation Models Only)

The shear on rotating models can be changed according to the needs of the job. When the shear head is rotated into the vertical position, already felled trees can be cut to length quite easily.

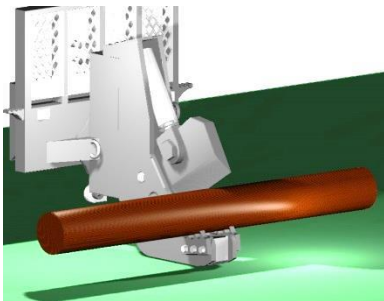

Vertical Shear Position

Maintaining your Attachment

Modifications

Modifications to the original design by the end user may result in weakening the designed structure and integrity of this attachment and will void any warranty.

Before Every Use

Check that all fasteners (nuts, bolts, pins, keepers) are in their right place and are tight.

Lubricate all pivot joints using #2 lithium grease.

Inspect and replace any worn, torn or missing safety decals.

Investigate the location of any oil leaks and repair.

Lube Chart	Number of Grease Fitting & Locations			
	Blade Pivot Shaft	Shear Cylinder Base Pin	Rotation Pivot Joint	Rotation Cylinder Pin
A	1	1		
B	1	1	1	
C	1	1	1	2

Every Week

Check the condition of the blade by opening the shear. Lower the attachment to the ground.

Inspect the shear blade and remove and sharpen it, if necessary. A sharp shear blade will cut more efficiently than a dull blade.

After Every Season

Inspect the implement for any loose or worn parts that may need to be replaced prior to the next cutting season.

Visually inspect the cutting blade. Sharpen or replace it, if necessary.

Clean, sand & repaint any area that looks worn or scratched to prevent further rusting. Use an equipment-paint found at your local hardware store or building center.

Lubricate all the pivot joints before storage. If storing in a saltwater environment, apply grease to the exposed chrome cylinder rod(s).

Store your implement in a shed or cover with a water-proof tarp to protect it from the weather. Store in an area not frequented by children.

Blade Sharpening

The abrasion resistant blade material will work for a long time without the need for sharpening. If required, sharpen the edge of the blade with a disk grinder or similar device. Maintain the factory edge bevel across the length of the cutting surface. Do not overheat the blade edge.

Blade Removal & Installation

⚠ CAUTION *Be cautious during the following steps. If dropped, the shear blade could result in Minor or Serious Injury.*

⚠ CAUTION *Shear blade can be very sharp and could cause Minor or Serious Injury if mishandled. Always wear protective gloves and footwear.*

Blade Removal:

⚠ WARNING *To avoid an accident that could result in Death or Serious Injury, never find yourself in a position where any body part is under the shear when servicing this attachment.*

Before removing the blade open the blade to its full open position, then rotate blade back about 1" (25 mm). Lift the shear with the skid steer or overhead hoist and support the shear on a couple of timbers or steel saw-horses.

The blade is extremely heavy. Connect a lifting eye through the blade and secure with a nut underneath the blade (See picture).

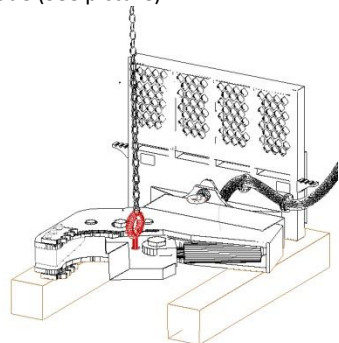

Shear placed on timbers w/ lift eye attached

Remove the bolt at the cylinder connection. Next loosen the two bolts on either side of the blade pivot pin remove the shear blade pivot pin. Carefully slide the blade out of the frame using a little assistance from the overhead hoist.

Blade Inspection:

Inspect the blade for any signs of cracks or bending. If a crack is found in the blade or the blade is no longer straight, replace the blade.

Blade Life:

After several years of operation, the life of the blade may depend on the number of times you have needed to sharpen the blade’s edge. If the gap between the closed blade and the frame is more than 3/8” (10 mm), your shear would operate more efficiently if a new blade was installed.

Blade Installation:

Position the blade into position using the lift eye and hoist and install into position lining up the blade pivot hole with the hole in the frame. Install the pivot shaft and secure the blade pivot hardware.

Rotate the blade to line up the blade with the cylinder rod yoke and install hardware.

Torque all hardware items according to the Torque Chart found below.

Lubricate the blade pivot joint before returning to work.



Hydraulic System

⚠️ WARNING A small stream of oil from a pinhole leak could penetrate your skin if contacted. To avoid an accident that could result in Death or Serious Injury, never use your hand or other body parts in an attempt to locate a hydraulic leak.

NOTICE Always release the hydraulic system pressure from the shear circuit prior to removing the attachment or any hydraulic system service work.

Be kind to the environment. Repair any hydraulic leaks immediately!

Hardware Torque

	Grade 2 lb-ft 	Grade 5 lb-ft 	Grade 8 lb-ft 
1/4"	66*	8	12
5/16"	10	17	20
3/8"	20	30	45
1/2"	45	75	110
3/4"	160	260	380
7/8"	190	400	600
1"	-	580	900

* = inch pounds

All values are “dry” torques.

Parts

When requiring any parts for your implement, please collect the following information:

Implement Model Number
Implement Serial Number
Cut Width
Parts Manual Date (lower right corner)
Parts Manual Page
Part Description
Quantity Required
Ship-to Name & Address
Payment Method

...then call your local dealer for factory fresh parts specifically designed for your attachment.

**Use Genuine Parts
from
Construction
Implements Depot
INC.**

Non-Rotating Tree Shear Parts

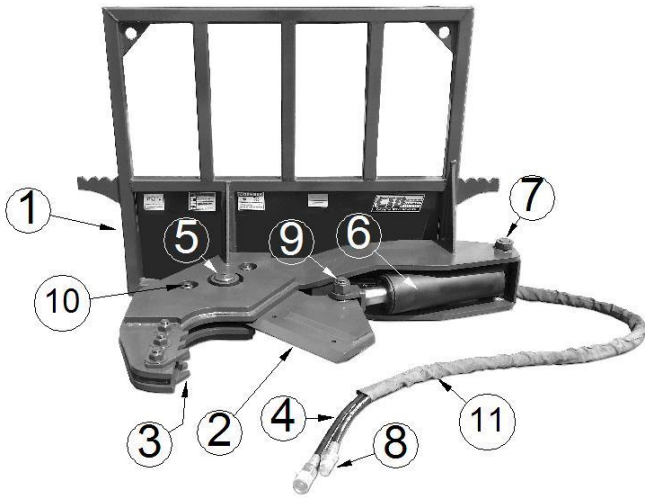

Ref.	Description	Qty.
1	Main Frame	1
2	Shear Arm	1
3	Tree Grip Set	1
4	Hose (Pair)	1
5	Pivot Shaft, Blade Arm	1
6	Cylinder	1
	Fitting, 90°	2
7	Pin, Cylinder base	1
8	Quick Disconnect Coupling Set	2
9	Bolt Set, (Cylinder Rod End)	1
10	Bolt Set (Shear Arm Mounting)	1
11	Wear Sleeve, Hose	1

Rotating Tree Shear

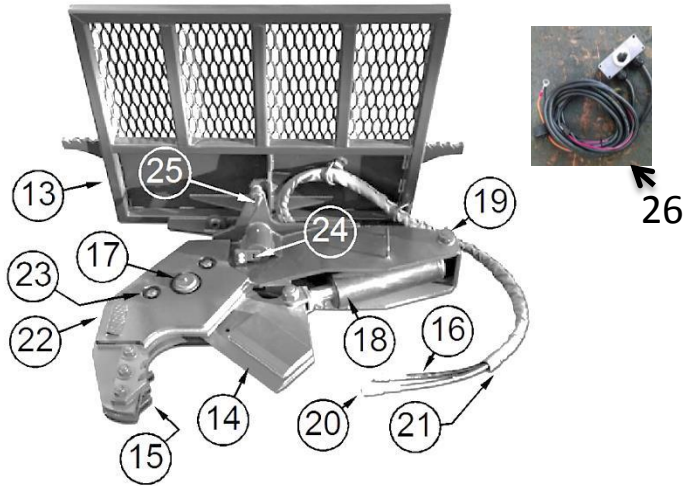

Ref.	Description	Qty.
13	Coupler Frame	1
14	Shear Arm	1
15	Tree Grip Set	1
16	Hose (Pair)	1
17	Pivot Shaft, Blade Arm	1
18	Cylinder	1
	Fitting, 90°	2
19	Pin, Cylinder Base	1
20	Quick Disconnect Coupling Set	1
21	Wear Sleeve, Hose	1
22	Frame, Shear Arm	1
23	Bolt Set (Shear Arm Mounting)	1
24	Shear Pivot Locking Tab & Hardware Set	2
25	Pin, Pivot Lock	1
NS	Cylinder, Shear Rotator (Hyd. Rotation Models Only)	1
NS	Pin, Shear Rotator Cylinder – Base End (Hyd. Rotation Models Only)	1
NS	Pin, Shear Rotator Cylinder – Rod End (Hyd. Rotation Models Only)	1
NS	Electrically Operated Control Valve (Hyd. Rotation Models Only)	1
NS	Hose Set – From Valve to Rotation Cylinder (Hyd. Rotation Models Only)	1
NS	Selector Valve (Hyd. Rotation Models Only)	1
26	Electrical Switch Harness (Hyd. Rotation Models Only)	1
NS = Not shown in above picture (Refer to drawing on page 19)		

Decals

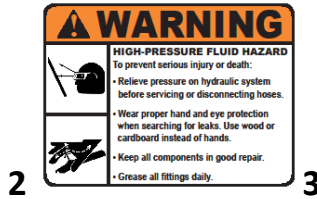
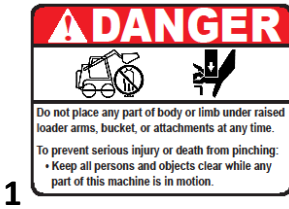

**MUST READ
 OPERATOR MANUAL
 MUST READ
 OPERATOR MANUAL
 MUST READ
 OPERATOR MANUAL
 MUST READ
 OPERATOR MANUAL
 MUST READ
 OPERATOR MANUAL**



Ref.	Description	Qty.
1*	Decal, (Danger Pinch Points)	2
2*	Decal, (Warning, High Pressure Fluid Hazard)	1
3	Decal, Must Read Operator Manual	1
4	Decal, Made in the USA	1
5	Decal, Registration & Warranty Info	1
6	Decal, Clean debris from hydraulic couplers	1

***  WARNING** *Replace any worn, torn or missing safety decals before operating!*

Troubleshooting

Problem	Cause	Resolution
Blade get dull too quickly	Blade has contacted solid objects (rocks, steel pipes, etc.)	Clear cutting area of solid objects before hitting them, or raise the shear height to clear exposed rock surfaces.
Blade breaking or bending	Excessive bending loads	Do not use this attachment as a tree puller or a skidder. It is designed to shear the trees.
Skid steer hydraulic oil level goes down during operation	Leak between skid steer and attachment cylinder	Investigate & repair
	Leaks in skid steer hydraulic system	Investigate & repair
Hydraulic Shear Rotation does not work (Hydraulic rotation models only)	No electrical power source	Check that the 12V power source and a good ground is present. Check circuit fuse and replace if necessary. Check if wire between power source and switch, or between skid steer and hydraulic valve has been damaged. Check electrical connections on diverter valve on shear.
	Valve not shifting due to solenoid failure	Shut off skid steer and release pressure in the auxiliary circuit. Remove the shift cartridge and check if a contaminant is blocking the valve action. Check if solenoid coil is working.

Specifications

Spec.	Model		
	Non-Rotating Shear	Manual Rotating Shear	Hyd. Rotating Shear
Weight	975 lbs. (442 kg)	1025 lbs. (465 kg)	1075 lbs. (488 kg)
Shearing Force	60,000 lbf. (266893 N)		
Cutting Capacity	12" (305 mm)		
Fell Direction	Right		
Lube Points	2	3	5
Blade Thickness	1" (25.4 mm)		
Blade Material	AR400		
Shear Cylinder	5" X 12" (127 x 305 mm)		
Shear Rotation	None	0° or 90°	Infinite between 0° & 90°
Min. SSL Power	45 HP (34 kW)		
Hyd. Relief Setting	3000 PSI (207 bar)		
Warranty	12 months - See complete Warranty Statement for details		

X-treme Non-Rotating Tree Shear ***Dimensions***

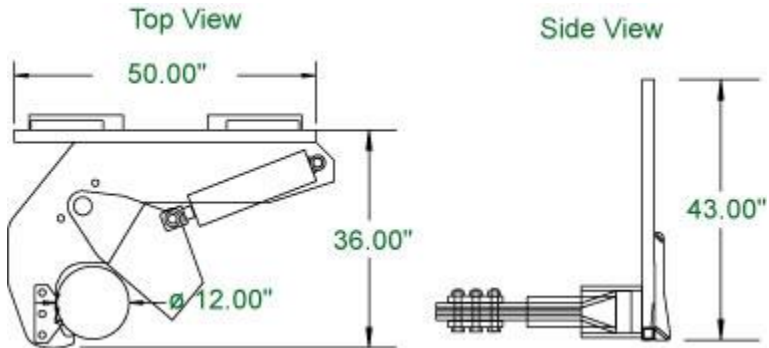

X-treme Rotating Tree Shear

Dimensions

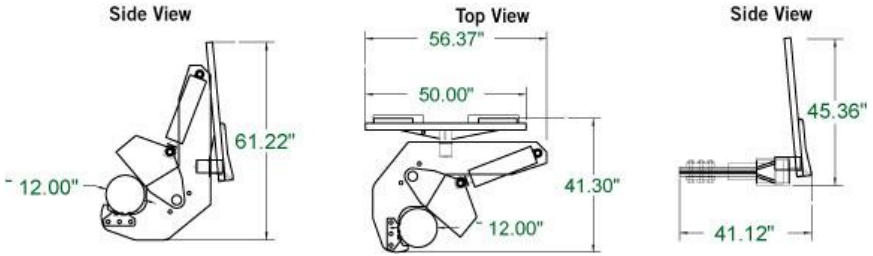

Hydraulic/Electrical Drawing

Hydraulic Rotation Model Only

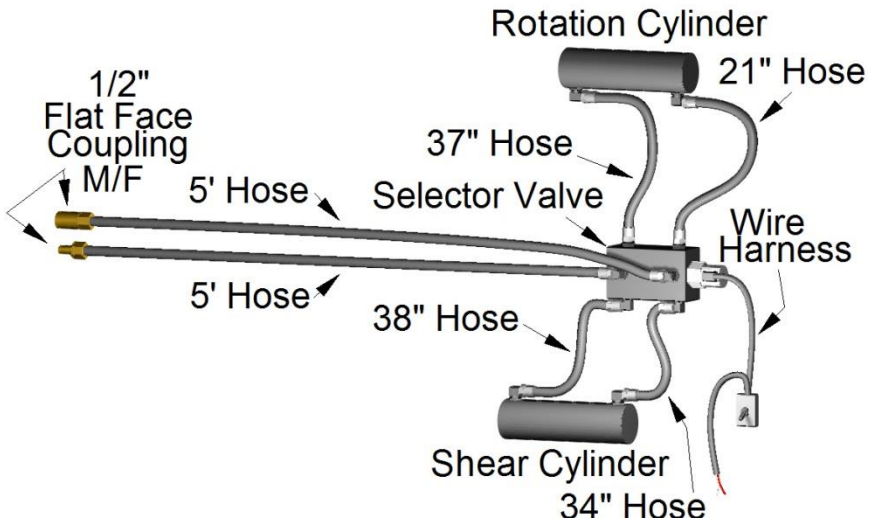



Owner's Manual

X-treme

Tree Shear

Website

www.cidattachments.com

For More Information, Contact

sales@cidattachments.com

Phone: (336)859-2002

1248 N. Main
PO Box 397
Denton, NC 27239

Limited Warranty

Construction Implements Depot, Inc. products are warranted to be free from defects in workmanship or materials for period of (12) months from initial sale, lease or rental date.

Warranty Exclusions

This warranty does not cover normal wear items, including but not limited to, bearings, hoses, ground engaging parts such as, teeth, blades, cutting edges, pilot bits, auger teeth and broom bristles. This warranty does not cover maintenance, service or adjustments. This warranty does not cover damage due to misuse, negligence, accidents, or improper maintenance. This warranty does not cover damage due to improper application, installation, contamination, adjustment or setup. This warranty does not cover improper modifications of product. This warranty is void if any components have been disassembled, i.e. pumps, gear boxes, motors.

Specially modified attachments built by CID X-treme Attachments to meet your customer's needs shall not be warranted by Construction Implements Depot, Inc. This warranty does not cover replacement parts not supplied by CID, Inc.

Warranty Statement

Our obligation under this Limited Warranty shall be solely limited to repairing or replacing any part (see non-covered items) free of charge that, according to our judgment, show evidence of a defect in quality of workmanship or materials for the stated (12) month warranty period. All defective parts must be routed directly to CID, Inc. with freight or delivery charges to be prepaid. This Limited Warranty shall not be interpreted to render CID, Inc. liable for any injury or damage to persons, business or property of any kind nor expenses or losses incurred for labor, supplies, substitute machinery rental, or for any other reason. Repair or replacement parts are subject to the supply conditions at the time of repair or replacements, which may directly affect our ability to obtain material and/or replacements parts. CID, Inc. reserves the right to make improvements in design or changes in specifications at any time without incurring any obligations to owners of previously purchased units. No one but CID, Inc. is allowed to alter, modify or enlarge this warranty nor the exclusions, limitation and reservation at any time.