



IRONCRAFT



3515 SERIES FLEX-WING ROTARY CUTTER

OPERATION MANUAL



Read and understand the manual. This manual provides information and procedures to safely operate and maintain the Rotary Cutter.



July 2022

Pre-Delivery Checklist

The Dealer should inform the Purchaser of this product of the Warranty terms, provisions, and procedures that are applicable. The Dealer and Purchaser should review the contents of the Operation and Parts Manual including safety equipment, safe operation and maintenance, review the Safety Signs on the implement (and tractor if necessary), and the Purchaser's responsibility to train their operators in correct operating procedures.

- **IMPLEMENTS:** I have explained that Deflectors, Guards, or Shields must be installed and maintained in good repair.
- I have explained that it is not possible to guard against thrown objects when the cutter is lifted off the ground, and that the operator is responsible for watching out for persons in the work area.
- **DRIVELINES:** I have made certain that all driveline, gearbox, and other shields are in good repair and fastened securely in place to prevent injuries from entanglement or thrown objects.

PRE-DELIVERY SERVICE CHECK AND ADJUST OR LUBRICATE AS REQUIRED

See Operation and Parts Manual for Details

Inspection Performed - Warranty and Safety Procedures Explained - Installation Complete

LUBRICATION & HYDRAULICS

- Gearbox Lubricant Level, Factory Filled
- Make Sure Hydraulic Cylinders are Properly Charged and Purged
- Grease All Zerks

CUTTER

- Make Sure that Slip Clutches Operate Properly
- Make Sure the Gearbox Bolts are Properly Tightened
- Make Sure that Blade Carrier Bolts are Properly Tightened and Cotter Pins are in Place
- Make Sure that Blades are Installed in Correct Rotational Direction
- Make Sure that All Hardware is Properly Tightened
- Review Procedure to Adjust Cutting Height and Level

ATTACHMENTS & INSTALLATION

- Make Sure the Chain Shielding is Attached
- Make Sure All Bolts, Pins, and Nuts Are Properly Installed and Tightened

CUTTER TO TRACTOR CONNECTIONS

- Make Sure Hitch Pin and Clevis are Properly Installed
- Complete All Pre-Operation Checks. Refer to "6.7 Pre-Operation Checklist" on page 37

SAFETY ITEMS

- Make Sure Protective Shields are Properly Installed
- Make Sure Safety Decals are Installed
- Review Operation and Parts Manual (Supplied)
- Make Sure Tractor PTO Shield is Installed
- Make Sure S.M.V. Sign is Installed if Needed
- Make Sure ADMA Driveline Safety Manual is Supplied
- Make Sure AEM Mower Safety Manual is Supplied
- AEM Mower Safety Video has Been Shown to Purchaser

I have thoroughly instructed the buyer on the above-described equipment. This review included the Operation and Parts Manual content, equipment care, adjustments, safe operation, and applicable warranty policy.

Date _____

Dealer Rep. Signature _____

The above equipment and Operation and Parts Manual have been received by me, and I have been thoroughly instructed as to care, adjustments, safe operation, and applicable warranty policy.

Date _____

Owner's Signature _____

Send a copy of your Pre-Delivery Checklist to IronCraft along with this page.

Requester Name: _____ Phone: _____

Requester Address: _____

City: _____ State: _____

Zip Code: _____

Cutter Model: _____ Serial Number: _____

Date Purchased: _____ Dealer Salesperson: _____

Dealership Name: _____ Dealership Location: _____

Mail to:

IronCraft
P.O. Box 968
Athens, TN 37303

Or Fax to:

(423) 334-0023

Or E-mail to:

sales@ironcraftco.com

Cut Here to Remove Page or Make Copies of This Page

Table of Contents

1. INTRODUCTION	8	6.3 Attaching to Tractor	33
1.1 Welcome	8	6.4 Setting the Rotary Cutter	35
1.2 Safe Operation	8	6.4.1 Leveling Front-to-Back	35
1.3 Safety Shields	8	6.4.2 Setting the Cutting Height	35
1.4 Specifications	9	6.5 Initial Setup Checklist	36
1.5 Intended Usage	9	6.6 Machine Break-In	37
1.6 Operator Orientation	9	6.7 Pre-Operation Checklist	37
1.7 Serial Number Location (Typical)	9	6.8 General Operating Procedure	37
1.8 Product Improvements	10	6.9 Chain Shielding	38
1.9 Disposal of Equipment at End of Useful Life ..	10	6.10 Right of Way (Roadway) Mowing	39
1.10 Unanswered Questions	10	6.11 Detaching From Tractor	39
2. SAFETY	11	7. TRANSPORTING	41
2.1 General	11	7.1 Transporting Safety (Road)	41
2.2 Safety Alert Symbols	11	7.2 Transporting	42
2.3 Safety Icon		8. STORAGE	43
Nomenclature	12	8.1 Storage Safety	43
2.3.1 Personal Protection/ Important Information	12	8.2 Placing In Storage	43
2.3.2 Prohibited Actions	12	8.3 Removing From Storage	43
2.3.3 Hazard Avoidance	12	9. SERVICE AND MAINTENANCE	44
2.4 Training	14	9.1 Maintenance Safety	44
2.5 OSHA Training Requirements	14	9.2 Welding Repairs	45
2.6 Federal Laws and Regulations	15	9.3 Greasing	46
2.7 Sign-Off Form	16	9.4 Gearbox Lubrication	47
2.8 Operation Safety	17	9.5 Driveline Lubrication	47
2.9 Transporting Safety	17	9.6 Blade Servicing	47
2.10 Storage Safety	17	9.6.1 Blade Removal	47
2.11 Maintenance Safety	17	9.6.2 Blade Installation	47
3. SAFETY SIGNS AND INSTRUCTIONAL LABELS	18	9.6.3 Blade Sharpening	48
3.1 General Information	18	9.7 Blade Carrier Removal	48
3.2 How to Install Replacement Safety Signs	18	9.8 Blade Carrier Installation	48
3.3 Safety Sign Locations	19	9.9 Slip Clutch Operational Check	48
3.3.1 Cutter Deck Safety Signs	20	9.10 Slip Clutch Adjustment	49
4. NOMENCLATURE	23	9.11 Bolt Torque Requirements	50
4.1 Description and Intended Use	23	9.12 Service Record	51
4.1.1 Owner/Operator Manual Storage	23	10. TROUBLESHOOTING	52
4.2 Nomenclature	23	11. WARRANTY	54
5. ASSEMBLY	24	12. PARTS INFORMATION	58
5.1 Tools Required	24		
5.2 Assembly Procedure	24		
5.3 Final Assembly and Leveling	27		
5.3.1 Leveling the Center Deck	27		
5.3.2 Leveling the Wing Decks	28		
5.4 Checking the Driveline Length	30		
5.5 Shortening the Driveline	30		
6. OPERATION	31		
6.1 User Safety Training	31		
6.2 Tractor Requirements	32		
6.2.1 Equipment and Capabilities	32		
6.2.2 Tractor Safety Devices	32		
6.2.3 ROPS and Seat Belt	32		
6.2.4 Power Take-Off (PTO)	33		
6.2.5 Drawbar	33		

1. INTRODUCTION

1.1 Welcome



IronCraft 3515 Flex-Wing Rotary Cutter

Congratulations on your choice of a IronCraft flex-wing rotary cutter. This equipment has been designed and manufactured to meet the needs of discerning users.

Many features incorporated into this rotary cutter are the result of suggestions made by customers like you. Read this manual carefully to learn how to operate the rotary cutter safely and how to set it to provide maximum cutting efficiency.

By following the operating instructions, in conjunction with a good maintenance program, your IronCraft rotary cutter will provide many years of trouble-free service.



1.2 Safe Operation

Safe, efficient, and trouble-free operation of your rotary cutter requires that you, and anyone else who will be using or maintaining the unit, read and understand the information contained within the Owner's Manual.

Use this manual for frequent reference and to pass on to new operators or owners.

WARNING



Read And Understand Manual

To prevent personal injury or even death, be sure you read and understand all of the instructions in this manual and other related OEM equipment manuals! The rotary cutter, if not used and maintained properly, can be dangerous to users unfamiliar with its operation. Do not allow operating, maintaining, adjusting, or cleaning of this rotary cutter until the user has read this manual and has developed a thorough understanding of the safety precautions and functions of the unit.

This rotary cutter is designed for the specific purpose of cutting grass, weeds, and brush. **DO NOT** modify or use this rotary cutter for any application other than that for which it was designed.

Rotary cutters maintained or operated improperly or by untrained personnel can be dangerous; exposing the user and/or bystanders to possible serious injury or death.

1.3 Safety Shields

Some of the illustrations in this manual may show the equipment with safety shields removed for clarity. Never operate the rotary cutter unless all safety shields are in place.

WARNING



Cutting or Entanglement Hazard

Operating the rotary cutter without the safety shields can result in physical injury or death. Make sure all shields are properly installed before operating the rotary cutter. This equipment should never be operated with any safety shielding removed.

1.4 Specifications

Model	3515
Cutting Width	15'
Cutting Height	2" to 15"
Overall Width	188"
Transport Width	90"
Hitch	Swivel Pivot Self Leveling
Underneath Deck	Heavily Braced
Minimum Tractor PTO	60 HP
Deck Thickness	10 Gauge
Side Skirt	1/4" x 13.5"
Approximate Weight	5600 LBS w/ six 26" Laminated Tire
Approximate Tongue Weight	1900 LBS
Blades	1/2" x 4" Uplift
Blade Tip Speed	17,135 FPM
Blade Overlap	6"
PTO Driveline	ASAE Cat 6
Wing Driveline	ASAE Cat 4
Wing Free Float	22° Down / 45° Up
Wing Flex	22° Down / 87° Up
Splitter Gearbox Rating	235 HP
Outboard Gearbox Rating	190 HP
Gearbox Warranty	5 Year Limited
Machine Warranty	1 Year Limited
Cutting Capacity	3.5"
Cutter Suspension	2 Heavy Duty springs positioned on the center tail wheel axle
Safety Tow Chain	Standard
Chain Guards	Standard
Skid Shoes	Replaceable
Wheel Options	20" Laminated Tire
	26" Laminated Tire
	26" Foam Filled Aircraft Tires
	29" Pneumatic Aircraft Tires

Specifications subject to change without notice.

1.5 Intended Usage

Do not use this rotary cutter for any other purpose than its intended use of cutting grass, weeds, and brush.

1.6 Operator Orientation

The directions left, right, front, and rear, as mentioned throughout this manual, are as seen from the tractor operator's seat and facing in the direction of travel.

1.7 Serial Number Location (Typical)

The serial number decal is located on the left front of the center deck.

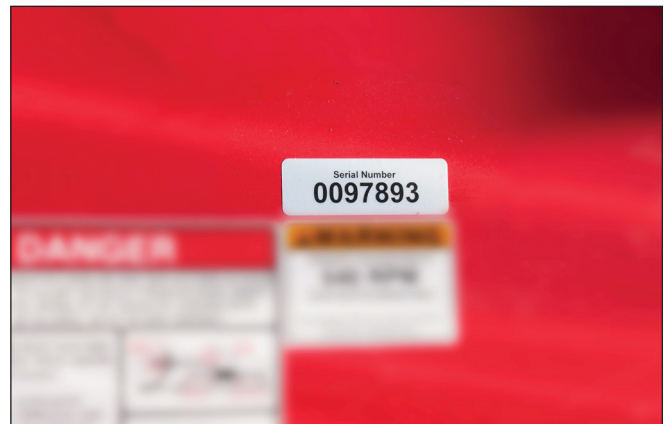

Serial Number _____

1.8 Product Improvements

Because IronCraft maintains an ongoing program of product improvement, we reserve the right to make improvements in design or changes in specifications without incurring any obligation to install them on units previously sold.

1.9 Disposal of Equipment at End of Useful Life

The IronCraft rotary cutter has been designed for the specific purpose of cutting grass, weeds, and brush. When this unit is no longer capable of doing its designed purpose, it should be dismantled and scrapped. Do not use any materials or components from this unit for any other purpose.

1.10 Unanswered Questions

If you have any questions not answered in this manual, require additional copies, or the manual is damaged, please contact your dealer or:

IronCraft
P.O. Box 968
7 Rocky Mount Road
Athens, TN 37303

Phone: (423) 405-5150
Fax: (423) 334-0023

The manual is also available for download at:
www.IronCraftco.com.

Navigate to the 3515 page for the manual link.

2. Safety

2.1 General

Safety of the operator and bystanders is one of the main concerns in designing and developing a new piece of equipment. Designers and manufacturers build in as many safety features as possible. However, every year many accidents occur which could have been avoided by a few seconds of thought and a more careful approach to handling the equipment.

Most work-related accidents are caused by failure to observe basic safety rules or precautions. An accident can often be avoided by recognizing potentially hazardous situations before an accident occurs. As you assemble, operate, or maintain the rotary cutter (unit), you must be alert to potential hazards. You should also have the necessary training, skills, and tools to perform any assembly or maintenance procedures.

Improper operation and maintenance of this unit could result in a dangerous situation that could cause injury or death.

If you have any questions not answered in this manual or require additional copies or the manual is damaged, please contact your dealer or:

IronCraft
P.O. Box 968
7 Rocky Mount Road
Athens, TN 37303
Phone: (423) 405-5150
Fax: (423) 334-0023

WARNING



Do not assemble, operate, or maintain the unit until you read and understand the information contained in this manual.



Safety precautions and warnings are provided in this manual and on the unit. If these hazard warnings are not heeded, bodily injury or death could occur to you or to other persons.

IronCraft cannot anticipate every possible circumstance that might involve a potential hazard. The warnings in this manual and on the unit are, therefore, not all-inclusive. If a method of assembly, operation, or maintenance not specifically recommended by us is used, you must satisfy yourself that it is safe for you and for others. You should also ensure that the unit will not be damaged or be made unsafe by the methods that you choose.

The information, specifications, and illustrations in this manual are based on the information that was available at the time this material was written and can change at any time without notice.

2.2 Safety Alert Symbols



This is the safety alert symbol. It is used to alert you to potential personal injury hazards. Obey all safety messages that follow this symbol to avoid possible injury or death.

This manual contains DANGERS, SAFETY INSTRUCTIONS, CAUTIONS, IMPORTANT NOTICES, and NOTES which must be followed to prevent the possibility of improper service, damage to the equipment, personal injury, or death. The following key words call the readers' attention to potential hazards.

Hazards are identified by the "Safety Alert Symbol" and followed by a signal word such as "DANGER", "WARNING", or "CAUTION".

DANGER

Indicates an imminently hazardous situation which, if not avoided, will result in death or serious injury. This signal word is limited to the most extreme situations.

WARNING

Indicates a potentially hazardous situation which, if not avoided, could result in death or serious injury.

CAUTION

Indicates a potentially hazardous situation which, if not avoided, may result in minor or moderate injury.

NOTICE

Indicates that equipment or property damage can result if instructions are not followed.

SAFETY INSTRUCTIONS

Safety instructions (or equivalent) signs indicate specific safety-related instructions or procedures.

Note: Contains additional information important to a procedure.

2.3 Safety Icon Nomenclature

Pictorial icons signal a type of hazard and warn of personal protection issues, prohibited actions, and hazard avoidance.

2.3.1 Personal Protection/ Important Information









-  Read the manual
-  Damaged hazard label
-  Eye protection
-  Fire extinguisher
-  First aid kit
-  Hand protection
-  Head protection
-  Hearing protection
-  OEM parts only
-  Protective shoes
-  Remove key
-  Set parking brake
-  Stop engine
-  Think safety
-  Transmission in park
-  Use proper support
-  Use proper tools
-  Visibility
-  Rollover protection

-  Wear seat belt
-  Weight rating
-  Clear vision

2.3.2 Prohibited Actions

-  Do not alter or modify
-  Do not leave out tools
-  Do not weld
-  No alcohol
-  No drugs
-  No smoking
-  No young children
-  No riders

2.3.3 Hazard Avoidance

-    Crush hazard
-  Crush hazard (chock wheels)
-  Crush hazard (foot)
-  Defective or broken part
-  Entanglement hazard
-  Explosive separation hazard
-  Fire hazard

-  Cutter blade contact hazard (hand)
-  Cutter blade contact hazard (foot)
-  Pinch point hazard
-  Projectile hazard
-  Rollover protection
-  Safety alert symbol
-  Safety shields
-  Sharp object hazard
-  Slipping injury
-  Stay clear
-  Zero pressure
-  Tripping injury
-  High-pressure fluid hazard
-  Hose damage
-  Falling hazard
-  Crush hazard
-  Pressure hazard

General Safety Instruction

The owner/operator is responsible for the SAFE use and maintenance of the rotary cutter. Make sure anyone who is operating, maintaining, or working around the rotary cutter is familiar with the operating and maintenance procedures and related SAFETY information contained in this manual. This manual will take you step-by-step through your working day and alerts you to all good safety practices that should be used while using the rotary cutter.

In addition to the design features of the rotary cutter, including safety signs, accident prevention is dependent upon the awareness, concern, prudence, and proper training of the people involved in the operation, maintenance, and storage of the rotary cutter.

In addition to this safety section, refer also to safety messages and instructions in each of the appropriate sections of the rotary cutter manual.

These general safety instructions apply to the overall use and maintenance of the rotary cutter.

More specific instructions on safety are found in the operation, maintenance, and storage sections of this manual. Refer to these sections before performing any of these tasks.

WARNING

Failure to comply with the following safety instructions can and will result in serious injury and possibly even death if they are not understood and followed.



Provide User with Literature

IronCraft rotary cutter owners must provide operator instructions to anyone using the rotary cutter before use, and at least annually thereafter. Refer to “2.5 OSHA Training Requirements” on page 14.



Stay Clear

Clear the area of people, especially small children, before using the rotary cutter. Under no circumstances should young children be allowed to work with or around the rotary cutter.



Impaired User Hazard

Do not attempt to assemble, operate, or maintain this rotary cutter under the influence of drugs or alcohol. Consult your doctor before using this rotary cutter while taking prescription medications.

WARNING



Crush Hazard

Do not allow anyone to ride on the tractor or the rotary cutter. Falling or crushing hazards can result in severe injuries or death.



Falling Hazard

Do not allow riders on the hitch, tractor, or rotary cutter at any time. Falling can result in severe injuries or death.



No Unauthorized Modifications

Do not modify the rotary cutter or safety devices. Do not weld on the unit. Unauthorized modifications may impair its function and safety. Personal injury or death can result from unauthorized modifications.

If the rotary cutter has been altered in any way from the original design, IronCraft does not accept any liability for injury or warranty.



Damaged Parts Hazard

Do not use the rotary cutter if any parts are damaged. If the rotary cutter has a defect, immediately stop using it and remedy the problem before continuing.



Thrown Objects Hazard

Rotary cutter can throw objects up to 300 feet. To avoid serious injury or death: Keep all thrown object shielding in place. Inspect area for potential thrown objects before cutting.

Do not operate the rotary cutter with the deck or wings raised.



Safety Shields

Some illustrations in this manual show the equipment with safety shields removed to provide a better view. This equipment should never be operated with any necessary safety shielding removed.

CAUTION

The following safety instructions are provided to help prevent potential injury. Not following these instructions may lead to injury.

Personal Protection Equipment

When using this rotary cutter, wear appropriate personal protective equipment. This list may include, but is not limited to:



- Protective shoes with slip resistant soles
- Protective goggles, glasses, or face shield
- Protective clothing and gloves
- Safety vest (when operating near roads)
- Hearing protection



Ear Protection

Wear suitable ear protection during prolonged exposure to excessive noise.



Hearing Loss

Prolonged Exposure To Loud Noise May Cause Permanent Hearing Loss!

Working environments with noise-producing equipment can cause partial to permanent hearing loss. We recommend using hearing protection any time noise levels exceed 80 decibels (dB). Noise levels over 85 dB, on a long-term basis, can cause severe hearing loss. Noise levels over 90 dB over a period of time can cause permanent and even total hearing loss.

Hearing loss from loud noise is cumulative over a lifetime without hope of natural recovery.



Crush Hazard

The tractor should be equipped with a Roll Over Protective Structure (ROPS) and a seat belt. A crushing hazard can occur if the driver is ejected from the seat while the tractor is in motion. Fasten the seat belt whenever the tractor is moving.

SAFETY INSTRUCTIONS

The following safety instructions are provided to help prevent injury or limit equipment damage.



Safety Signs

Replace any missing or hard-to-read safety signs or instructional labels. Use care when washing or cleaning the rotary cutter.

Replacement safety sign locations and part numbers are provided in this manual and are available from an authorized dealer parts department or the factory.



First Aid Kit

Have a first aid kit available for use should the need arise and know how to use it.



Fire Extinguisher

Have a fire extinguisher available for use should the need arise and know how to use it.



Think SAFETY!

Work SAFELY!

2.4 Training

Anyone who will be using and/or maintaining the rotary cutter must read, clearly understand, and follow ALL safety, operation, and maintenance information presented in this manual, other related OEM manuals, and the safety signs

If you do not understand any information in this manual, see your dealer or contact IronCraft before proceeding.

Do not use or allow anyone else to use this rotary cutter until all information has been reviewed. Annually review this manual before the season start-up.

Make periodic reviews of SAFETY and OPERATION of the rotary cutter a standard practice. An untrained operator is not qualified to use this rotary cutter.

2.5 OSHA Training Requirements

The following training requirements have been taken from Title 29, Code of Federal Regulations Part 1928.57 (a) (6). www.osha.gov.

Operator instructions. At the time of initial assignment and at least annually thereafter, the employer shall instruct every employee who operates an agricultural tractor and implements in the safe operating practices and servicing of equipment with which they are or will be involved, and of any other practices dictated by the work environment.

2.6 Federal Laws and Regulations

IMPORTANT FEDERAL LAWS AND REGULATIONS CONCERNING EMPLOYERS, EMPLOYEES AND OPERATORS

This section is intended to explain in broad terms the concept and effect of the following federal laws and regulations. It is not intended as a legal interpretation of the laws and should not be considered as such.

U.S. PUBLIC LAW 91-596 (The Williams-Steiger Occupational Safety and Health Act of 1970) OSHA

This Act Seeks:

“ ... to assure so far as possible every working man and woman in the nation safe and healthful working conditions and to preserve our human resources ... “

DUTIES

Sec. 5(a) Each Employer -

- (1) shall furnish to each of its employees employment and a place of employment which are free from recognized hazards that are causing or are likely to cause death or serious physical harm to its employees.
- (2) shall comply with occupational safety and health standards promulgated under this Act.
 - (b) Each employee shall comply with occupational safety and health standards and all rules, regulations, and orders issued pursuant to this Act which are applicable to his or her own actions and conduct.

OSHA Regulations

Current OSHA regulations state in part: “At the time of initial assignment and at least annually thereafter, the employer shall instruct every employee in the safe operation and servicing of all equipment with which the employee is, or will be involved.” These will include (but are not limited to) instructions to:

Keep all guards in place when the machine is in operation;

Permit no riders on equipment;

Stop engine, disconnect the power source, and wait for all machine movement to stop before servicing, adjusting, cleaning, or unclogging the equipment, except where the machine must be running to be properly serviced or maintained, in which case the employer shall instruct employees as to all steps and procedures which are necessary to safely service or maintain equipment.

Make sure no one is within 300 feet of machinery before starting the engine, engaging power, or operating the machine.

EMPLOYEE TRACTOR OPERATING INSTRUCTIONS:

1. Securely fasten your seat belt if the tractor has a ROPS.
2. Where possible, avoid operating the tractor near ditches, embankments, and holes.
3. Reduce speed when turning, crossing slopes, and on rough, slick, or muddy surfaces.
4. Stay off slopes too steep for safe operation.
5. Watch where you are going, especially at row ends, on roads, and around trees.
6. Do not permit others to ride.
7. Operate the tractor smoothly - no jerky turns, starts, or stops.
8. Hitch only to the drawbar and hitch points recommended by tractor manufacturers.
9. When tractor is stopped, set brakes securely and use park lock if available.

Child Labor Under 16 Years Old

Some regulations specify that no one under the age of 16 may operate power machinery. It is your responsibility to know what these regulations are in your own area or situation. (Refer to U.S. Dept. of Labor, Employment Standard Administration, Wage & Home Division, Child Labor Bulletin #102).

2.7 Sign-Off Form

IronCraft follows the general Safety Standards specified by the Farm Equipment Manufacturers Association (FEMA), and the American National Standards Institute (ANSI). Anyone who will be using and/or maintaining the rotary cutter must read and clearly understand ALL safety, operation and maintenance information presented in this manual.

This sign-off sheet is provided for your records to show that all personnel who will be working with the equipment have read and understand the information in this Operation and Parts Manual and have been instructed in the operation of the equipment.

Do not use or allow anyone else to use this rotary cutter until all information has been reviewed. Annually review this manual before the season start-up. Make periodic reviews of SAFETY and OPERATION of the rotary cutter a standard practice. An untrained operator is not qualified to use this rotary cutter.

Sign-Off Form		
Date	User's Signature	Owner's Signature

2.8 Operation Safety

Refer to “6.1 User Safety Training” on page 31 for safety recommendations related to using the rotary cutter. All applicable safety recommendations in other sections should also be followed.

2.9 Transporting Safety

Refer to “7.1 Transporting Safety (Road)” on page 41 for safety recommendations related to transporting the rotary cutter. All applicable safety recommendations in other sections should also be followed.

2.10 Storage Safety

Refer to “8.1 Storage Safety” on page 43 for safety recommendations related to storing the rotary cutter. All applicable safety recommendations in other sections should also be followed.

2.11 Maintenance Safety

Refer to “9.1 Maintenance Safety” on page 44 for safety recommendations related to maintaining the rotary cutter. All applicable safety recommendations in other sections should also be followed.

3. SAFETY SIGNS AND INSTRUCTIONAL LABELS

3.1 General Information

The types of safety signs (hazard labels) and instructional labels, along with their locations on the equipment, are shown in the following illustrations. Good safety practices require that you familiarize yourself with the various safety signs, the type of warning, and the area or particular operation related to that area that requires your SAFETY AWARENESS.



Think SAFETY!

Work SAFELY!

Pay close attention to the safety signs and instructional labels attached to the tractor and the rotary cutter. Duplicate safety signs, which are attached to the rotary cutter, can also be found in this section. If the rotary cutter is missing a label or one is unreadable, replace the label before using the rotary cutter.

SAFETY INSTRUCTIONS



Safety Signs and Instructional Labels

1. Keep safety signs or instructional labels clean and legible at all times. Use a clean, damp cloth to clean safety decals.
2. Replace any missing or hard-to-read safety signs or instructional labels.
3. Use care when washing or cleaning the equipment not to remove or damage the labels. When using a pressure washer to clean the rotary cutter, avoid spraying too close to decals; high-pressure water can enter through very small scratches or under edges of decals causing them to peel or come off.
4. Locations for the labels and replacement part numbers are shown in this section.
5. Replacement parts must have replacement labels attached during installation and/or before the rotary cutter is used.
6. Labels are available from your authorized dealer or from IronCraft at no charge.

3.2 How to Install Replacement Safety Signs

1. Clean and dry the installation area.

Note: Do not install the signs if the temperature is below 50°F.

2. Determine the exact position before you remove the backing paper.
3. Remove the backing paper.
4. Align the sign over the specified area and carefully press the sign to the part/frame.

Note: Small air pockets can be pierced with a pin and smoothed out using the piece of backing paper.

3.3 Safety Sign Locations

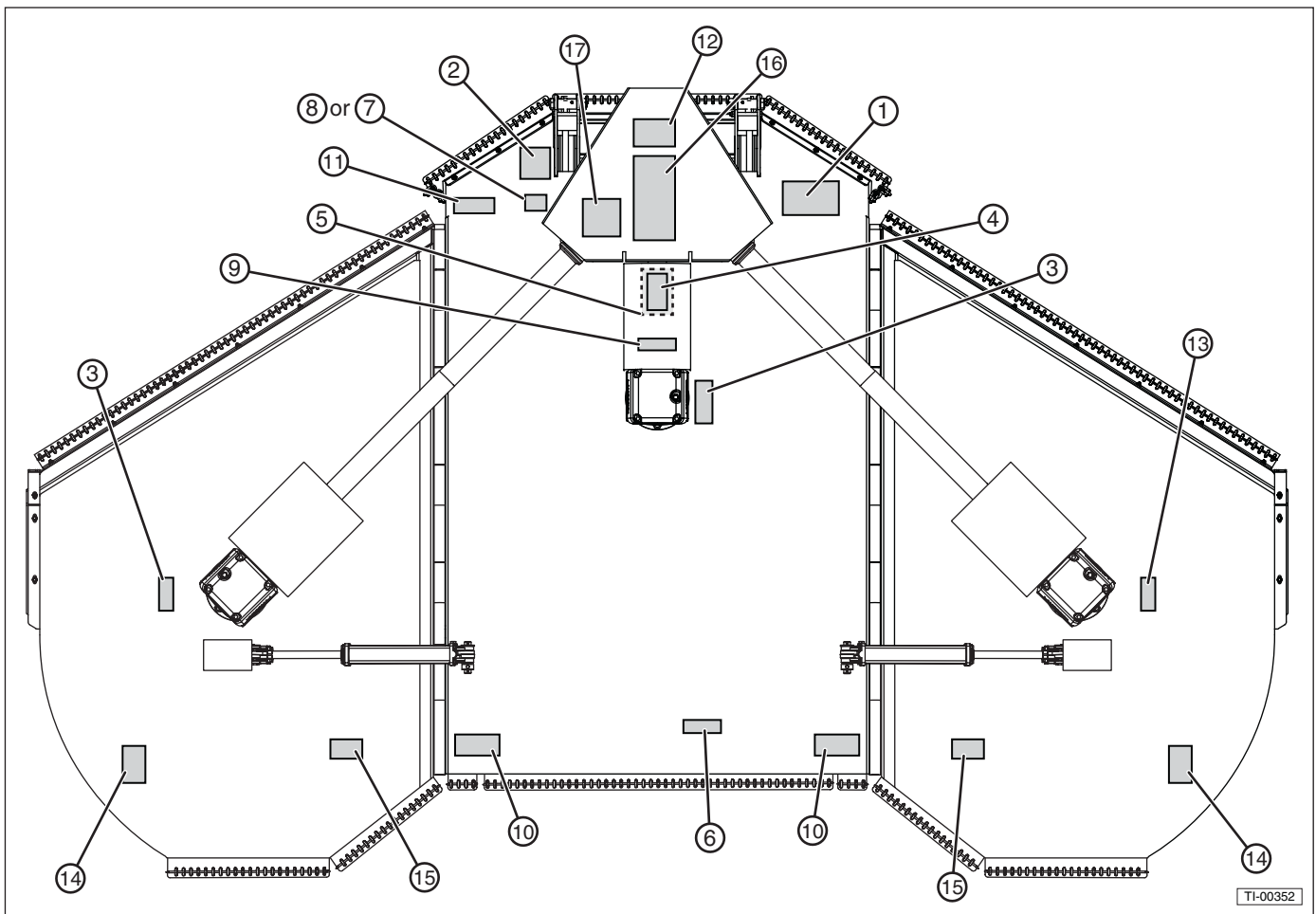

Safety Sign Locations.

Item	Type	Description	Qty.
1	DANGER	Follow Safety Messages	1
2	DANGER	Maintain Shields and Deflectors	1
3	INSTRUCTIONAL	Blade Rotation (CCW)	2
4	DANGER	Rotating Driveline, Keep Away, Outer Shield Tube	1
5	DANGER	Shield Missing, Do Not Operate	1
6	WARNING	Use Paper or Cardboard to Check for Leaks	1
7*	WARNING	PTO Speed 540 RPM	1
8*	WARNING	PTO Speed 1000 RPM	1
9	WARNING	Keep Mower Deck Clear of Debris	1
10	WARNING	No Riders	4
11	SERIAL	Serial Number	1
12	INSTRUCTIONAL	Made In the USA	1
13	INSTRUCTIONAL	Blade Rotation (CW)	1
14	DANGER	Keep Away - Thrown Objects	2
15	DANGER	Stay Clear	2
16	WARNING	Do Not Transport at Speeds Over 20 MPH	1
17	INSTRUCTIONAL	5 Year Gearbox Limited Warranty	1

* Use item 7 or 8, as appropriate.

3.3.1 Cutter Deck Safety Signs



1.

! DANGER

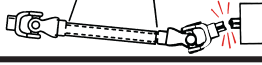
1. Make certain drivelines are of the correct length and securely attached. **DRIVELINE SEPARATION** and/or **PTO STUB SHAFT FAILURE** can cause **INJURY** or **DEATH**. (See Operator's Manual for procedure.)

<p><small>* SEE MANUAL FOR MINIMUM OVERLAP & MINIMUM/MAXIMUM LENGTHS</small></p> 	<p><small>BOTTOMING OUT</small></p> 
--	---

2. Make certain that driveline shields are **INSTALLED CORRECTLY** and **TURN FREELY** to prevent injury or death from entanglement.

	
---	---

3. Make certain that driveline is installed correctly on **TRACTOR PTO SHAFT**. Move yoke back and forth until locking collar clicks forward and locks yoke in place.

4. **540 PTO RPM** unless specifically marked otherwise.

TI-00336

2.

! DANGER

FAILING TO FOLLOW SAFETY MESSAGES AND OPERATING INSTRUCTIONS CAN CAUSE SERIOUS BODILY INJURY OR EVEN DEATH TO OPERATOR AND OTHERS IN THE AREA.

<p>1. READ MANUAL</p> 	<p>2. NO RIDERS, NO CHILDREN OPERATORS.</p> 	<p>3. USE SAFETY SHOES, HARD HAT, SAFETY GLASSES, SEAT BELTS, & ROPS.</p> 	<p>4. BLOCK UP SECURELY BEFORE WORKING UNDER.</p> 
--	--	--	--

1. Study and understand operator's manuals, safety signs, and instructional decals for tractor and implement to prevent misuse, abuse, and accidents.
 * Learn how to stop engine suddenly in an emergency. Be alert for passersby and especially children.
 2. Allow no children on or near implement or tractor. Allow no riders on tractor or implement. Falling off may cause serious injury or death from being run over by tractor or cutter or contact with rotating blades.
 3. Operate only with tractor having Roll-Over Protective Structure (ROPS) and with seatbelt fastened securely and snugly to prevent injury and possible death from falling off or tractor overturn. Personal Protective Equipment such as Hard Hat, Safety Glasses, Safety shoes, and Ear Plugs are recommended.
 4. Block up or support raised machine and all lifted components securely before putting hands or feet under or working underneath any lifted components to prevent crushing injury or death from sudden dropping or inadvertent operation of controls. Make certain area is clear before lowering or falling.
 5. Before transporting, put Lift Lever in detent or full lift positions. Secure the implement for transport by installing Cylinder Stops or Transport Pin on pin-type implement center axle and Wing Transport Locks on folding implements.
 * Attach Safety Chain to cutter and towing unit securely. See Operator's Manual.
 6. Make certain that SMV sign, Warning Lights, and Reflectors are clearly visible. Follow local traffic codes.
 7. Never operate with Cutting Head raised if passersby, bystanders, or traffic are in the area to reduce possibility of injury or death from objects thrown by Blades under Guards or cutter structure.
 8. Before dismounting, secure implement in transport position or lower to ground.
 * Put tractor in park or set brake, disengage PTO, stop engine, and remove key, and wait until noise of rotation has ceased to prevent entanglement in rotating parts which can cause injury or death.
 * Never mount or dismount a moving vehicle. Crushing from runover may cause injury or death.

<p>5. TRANSPORT SAFELY, LOCK UP.</p> 	<p>6. USE SMV, LIGHTS & REFLECTORS.</p> 	<p>7. DO NOT OPERATE WITH CUTTER OR WING RAISED.</p> 	<p>8. DO NOT MOUNT OR DISMOUNT WHILE MOVING.</p> 
---	--	---	---

TI-00337

3.



BLADE ROTATION

TI-00338

4.

! DANGER



ROTATING DRIVELINE

CONTACT CAN CAUSE DEATH

KEEP AWAY!

DO NOT OPERATE WITHOUT

- All driveline guards, tractor and equipment shields in place
- Drivelines securely attached at both ends.
- Driveline guards that turn freely on driveline

TI-00339

5.

! DANGER



SHIELD MISSING

DO NOT OPERATE

! DANGER

TI-00340

6.



TI-00342

10.



TI-00074

7.



TI-00344

11.

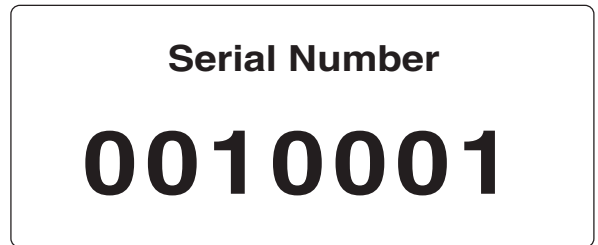

TI-00134b

8.



TI-00345

12.

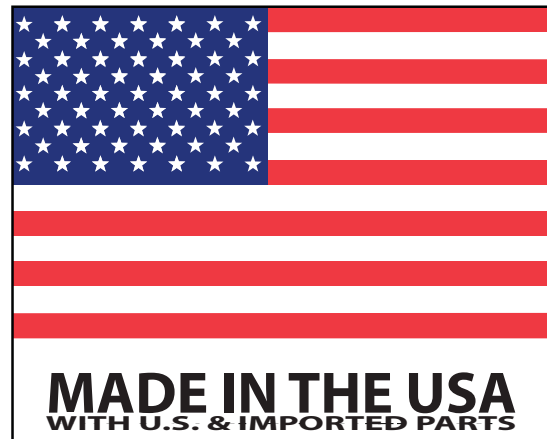

TI-00008

9.





TI-00343

13.

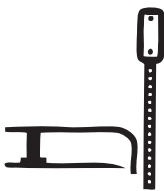

TI-00341

14.

! DANGER	
KEEP AWAY - THROWN OBJECTS	
	<ul style="list-style-type: none"> Inspect the area before mowing for potential mower hazards. Remove or avoid all foreign objects such as wire, cable, metal objects, and all other foreign material. Foreign material can be thrown from the mower and cause serious bodily injury to the operator and passersby.
	<ul style="list-style-type: none"> Do Not let rotating blades contact solid objects like rocks, posts, curbs or guard rails. Operate only if all Guards-Deflectors are in place and in good condition.
	<ul style="list-style-type: none"> Do Not operate with Mower or Wing raised off the ground. Stop mowing if Passersby enter the area of thrown objects. (See Operator's Manual)
	<ul style="list-style-type: none"> Stay away from rotating blades. Keep hands and feet away from rotating blades. Do Not approach mower until all motion has stopped.

TI-00346

15.

! DANGER	
	<ul style="list-style-type: none"> Stay clear when removing transport strap and lowering or raising wing. Component failure or accidental operation of controls may allow wing to fall suddenly and cause BODILY INJURY or DEATH. Cylinders with @ Restrictions installed must be filled with oil for wings to lower slowly and safely. Lock wings up securely for transporting.
	<ul style="list-style-type: none"> Do not operate mower with wings raised when passersby are in the area. Contact with Exposed Rotating Blades and/or being hit by thrown objects may cause INJURY or DEATH.

TI-00347

16.

NOTICE TO OWNER

An OPERATOR'S MANUAL (with Repair Parts Listing) and a WARRANTY REGISTRATION CARD were attached to this implement during final inspection at the factory. If they were not attached at the time of purchase, please contact your selling dealer at once.

1. Read and understand Manual before operating the implement.
2. Complete, sign, and mail the Warranty Registration Card in today.

IMPORTANT

**REQUIRED FOR JACK SHAFT UNIT
SUGGESTED FOR STANDARD SHAFT**

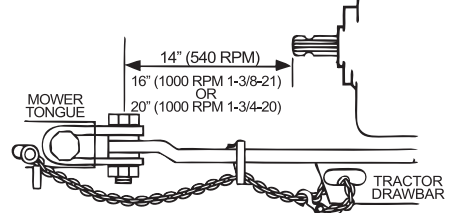

Attach Safety Chain securely as per ASAE S338

! WARNING



1. DO NOT transport at speeds above 20 mph. Exceeding 20 mph decreases braking ability and may cause loss of control and serious personal injury.
2. ONLY transport behind a properly sized and equipped tractor. NEVER tow behind a truck or other motor vehicle. ALWAYS properly fasten the implement safety tow chain to the tractor.
3. Reduce speed on inclines, while turning, and when towing in adverse conditions.
4. ENSURE a SMV emblem can be clearly seen from behind the unit. Turn ON the tractor flashing warning lights when transporting.

TI-00348

17.

5 YEAR

GEARBOX

LIMITED

WARRANTY

TI-00351

4. Nomenclature

4.1 Description and Intended Use

The rotary cutter is designed for heavy-duty applications such as weeds, grass, and brush up to 3.5" diameter. The cutter uses three spindles with two free-swinging blades each, which reduce the shock of impact when a stationary object is contacted. Slip clutches protect the gearboxes and driveline from damage. Standard equipment includes driveline shields, gearbox shields, and front and rear chain discharge shields.



4.1.1 Owner/Operator Manual Storage

Always store the Owner/Operator manual and other operating materials in the document storage tube located on the front gearbox shield.



5. Assembly

5.1 Tools Required

Tools Required
Wrenches, 1/2", 5/8", 3/4", 1-1/8", 1-3/8", 1-1/2"
Ratchet with extension and sockets as above

5.2 Assembly Procedure

1. Cut the wires holding the driveline to the cutter. Set the driveline aside for now.

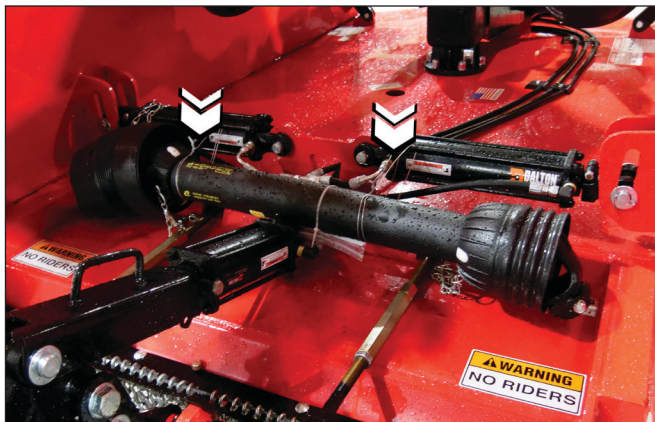

2. Verify that the wing uplock pins are in place.

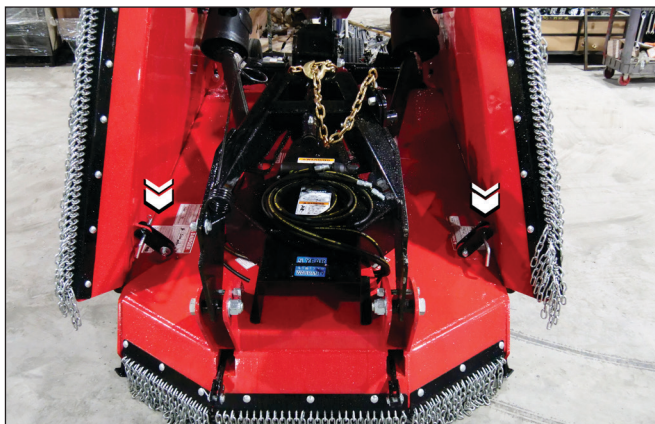

3. Remove the pins and washers.



4. Rotate the hitch forward using a suitable lifting device. The lifting device may be attached to the safety chain.



5. Install the pins and washers previously removed in Step 3, in the front of the leveling rods through the slot in the hitch.



6. Loosen the bolt and nut on the hose rack. Stand the rack up and tighten the bolt and nut.



7. Remove the jack from its storage location on the left wing and install it on the lug on the left side of the hitch.



9. Remove the retaining bolt from the front driveline.



10. Raise the front gearbox cover.

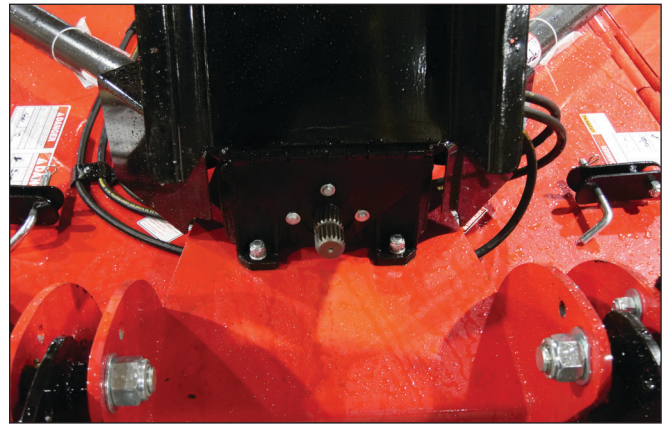

11. Install the driveline onto the gearbox input shaft. Insert the retaining bolt and tighten the locknut securely.

8. Lower the hitch using a suitable lifting device. The lifting device may be attached to the safety chain.

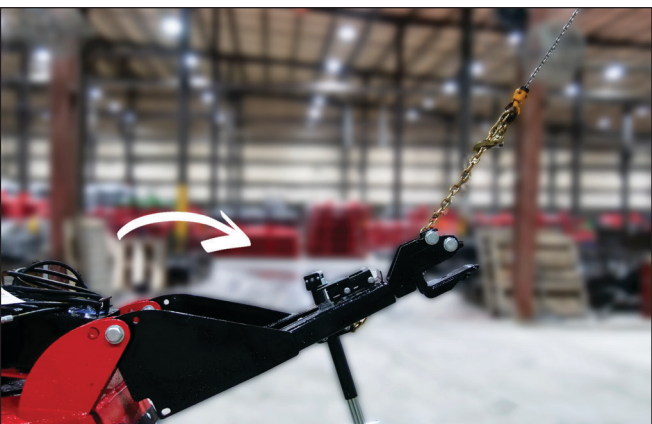



12. Attach the safety chain on the driveline guard to the gearbox cover.

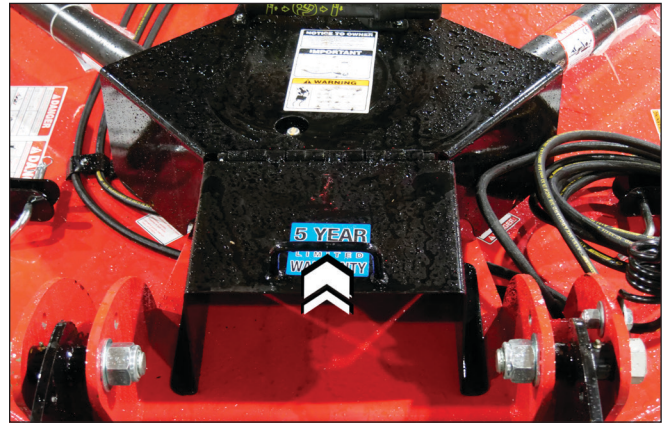

13. Separate the two halves of the driveline.

14. Apply a bead of grease around the end of the inner drive shaft.



⚠ WARNING



Crush Hazard

If the retaining bolt is not present, the driveline may separate from the gearbox, causing serious injury or death. Do not omit the retaining bolt. Tighten the locknut securely.

15. Slide the front driveline half over the rear half. Align the square rib on the mating halves to engage.

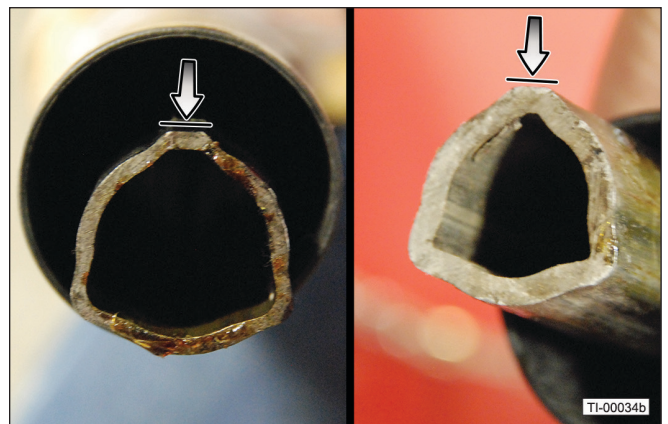

16. Apply grease to the zerks on the U-joint crosses.

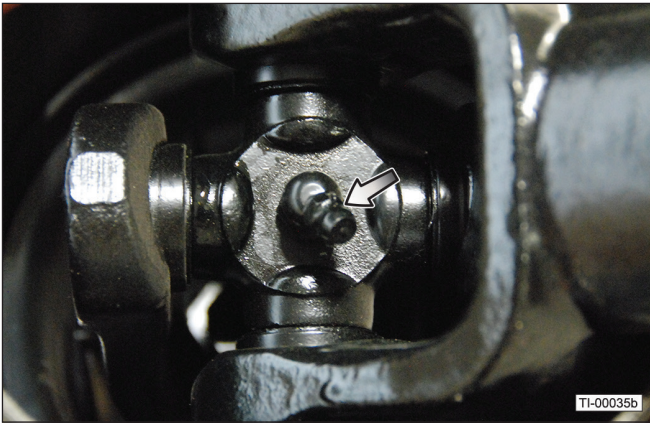

17. For the 29" Aircraft Tires, ensure the cutter height adjustment cylinder is pinned in the top hole (1) of the cutter deck and ensure the spindles for each tire are bolted in the innermost hole on the tailwheel axis. For all the other tire configurations, ensure the cutter height adjustment cylinder is pinned in the bottom hole (2) of the cutter deck and the spindles for each tire are bolted in the outermost hole on the tailwheel axes.



5.3 Final Assembly and Leveling

Attach the rotary cutter to the tractor. Follow the procedure in "6.3 Attaching to Tractor" on page 33.

Note: Quick disconnect hydraulic couplers are not supplied with the unit. If desired, these may be procured from a local equipment dealer.

5.3.1 Leveling the Center Deck

1. With the cutter attached to the tractor, disengage the PTO and park on a level, hard surface. Place the tractor gear selector in park or set the parking brake.
2. Cycle the wheel lift cylinder several times to purge any trapped air and charge the hydraulic cylinder.

NOTICE

The lift cylinder must not be bottomed out during this procedure, or the leveling rods may become bent.

3. Use the hydraulics to adjust the cutter height until the front of the skid shoes are two to three inches off the ground.



4. Adjust the nuts to have equal amounts of tension.
5. Remove the bolt and nut from the lower end of both tailwheel tubes.



⚠ WARNING



Unexpected Movement

The cutter is shipped with the wings in the upright position. If the wing uplock pins are not in place, and the banding between the tailwheel tubes is cut, the wings will free-fall due to air in the hydraulic system. To avoid death or serious injury from being struck by a wing, stay clear of the wings. Purge all air from the hydraulic system, and do not remove the wing uplock pins until necessary to do so.

6. Cut the banding between the tailwheel tubes. The tailwheels will swing freely when the banding is cut. Stand clear to avoid being struck by a tailwheel.



⚠ WARNING



Stay Clear

The tailwheels will swing freely when the banding is cut. To avoid injury from being struck by a tailwheel, stay clear of the tailwheels.

7. Rotate the tailwheel arms to align the holes with the clevis eye. Insert the bolt and reinstall the nut.

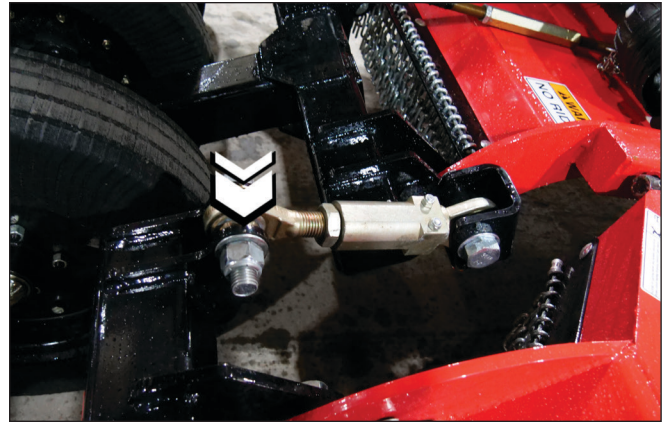

5.3.2 Leveling the Wing Decks

Each wing section will need adjusting if the wing top is not level with the center deck top when the wings are unfolded.

1. Start the tractor and cycle the wing lift control lever several times to purge any trapped air and charge the hydraulic cylinders.

NOTICE

The cutter does not have a hydraulic reservoir and therefore can deplete the oil in the tractor's reservoir during initial charging of the cylinders. Check the tractor's hydraulic oil reservoir after this initial setup and add oil as necessary.

2. Remove the wing uplock pins.



- To prevent loss, lay the lock-bracket back until hitting the stop, then install the pins in the hole for safe storage.

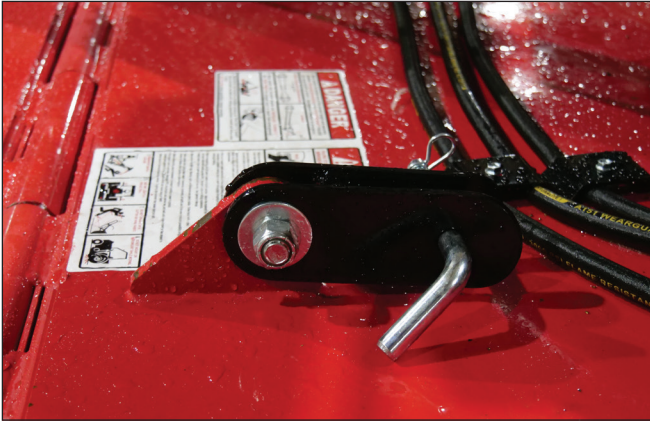

WARNING



Crush Hazard

Hydraulic or mechanical failure can allow a wing to drop suddenly without warning. Do not allow anyone to walk under or stand near a raised wing when the uplock pins are removed.

- Lower the wings.



Note: It is normal for the wings to lower or raise at different rates.

- If necessary, raise and lower the wings until all air is purged from the system, then lower the wings to the operating position.
- Check the tractor's hydraulic fluid reservoir and top off if necessary.
- Check wing tops to see if they are level with the top of the center deck. If the outer edge of either wing top is higher or lower than the center deck, then that wing should be leveled as follows:

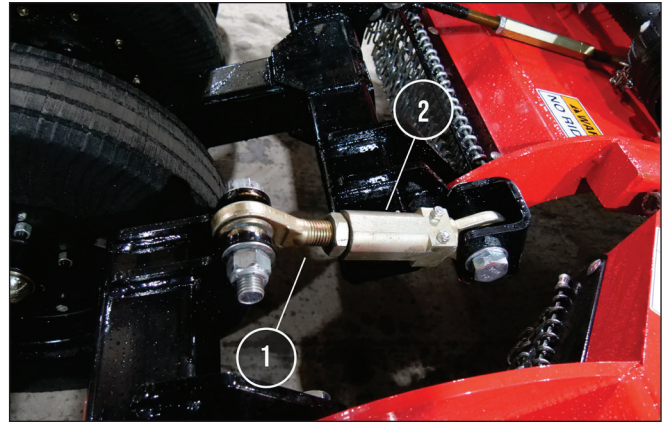

- If the outer wing edge is higher than the center deck, loosen jam nut (1) and rotate turnbuckle (2) counterclockwise to lower outer wing edge until wing is level. Tighten jam nut (1) to the correct torque when level.
- If outer wing edge is lower than the center deck, loosen jam nut (1) and rotate turnbuckle (2) clockwise to raise outer wing edge until wing is level. Tighten jam nut (1) to the correct torque when level.
- When properly adjusted, the turnbuckle length should be approximately 11.5".

5.4 Checking the Driveline Length

Before operating the rotary cutter, make sure the driveline will not bottom out or become disengaged. Bottoming out occurs when the inner shaft penetrates the outer housing until the assembly can shorten no more. Bottoming out can cause serious damage to the tractor PTO by pushing the PTO into the tractor and through the support bearings or downward onto the PTO shaft, breaking it off. A broken driveline can cause personal injury.

- Attach the rotary cutter to the tractor. Do not attach the driveline. Keep the driveline out of the way of moving parts.
- Raise and lower the rotary cutter to determine the maximum and minimum distance between the tractor PTO shaft and the gearbox input shaft. If the distance is too large, the driveline will be too short for proper engagement. If the distance is too small, the driveline may bottom out in operation and damage the rotary cutter or tractor.

There must be at least six inches of engagement at the rotary cutter's lowest possible point of operation, and the driveline must not bottom out when raised to the maximum height possible. If the driveline is too short, please call your IronCraft dealer for a longer driveline. If the driveline is too long, follow the

instructions for shortening the driveline.

5.5 Shortening the Driveline

1. Move the rotary cutter up and down to get the shortest possible distance between the tractor PTO shaft and the gearbox input shaft. Shut down the tractor PTO shaft and the gearbox input shaft. Shut down the tractor leaving the rotary cutter in the position of shortest distance. Securely block the rotary cutter in position.
2. Separate the driveline into two halves and connect them to the tractor PTO and gearbox.
3. Place the driveline halves parallel to one another to determine how much to shorten the driveline.
4. Each section should end approximately 3" short of reaching the universal joint shield on the opposite section. If too long, measure 3" back from the universal joint shield and mark on the opposite section.
5. Repeat Step 4 for the other half of the drive.

6. Raise and lower the rotary cutter to determine the position with the greatest distance between the PTO shaft and the gearbox input shaft. Shut down the tractor leaving the rotary cutter in the position of greatest distance. Securely block the rotary cutter in position.
7. Hold the driveline sections parallel to each other and check for minimum 6" overlap. If the driveline has been marked for cutting, the overlap will be the distance between the two marks. If the driveline has less than the minimum overlap, do not use. Contact your IronCraft dealer.

Note: If the driveline is the correct length, omit the following Steps 8 - 9 and proceed to Step 10.

8. Clamp a driveline section in a well-padded vice to prevent damage to the shield. Cut off the shield where marked. Using the cut off section of the shield as a guide, cut the shaft the same amount. Repeat for the other driveline section.
9. File and clean the cut ends of both drive halves. Remove all chips and filings.
10. Apply multi-purpose grease around the inner driveline section. Slide the drive halves over each other several times to distribute the grease. Install the driveline on tractor and rotary cutter. Make certain the driveline shielding is in place and in good condition.

Note: Do not use the rotary cutter if proper driveline engagement cannot be obtained through these methods. Contact your IronCraft dealer.

11. Set the tractor lift control stop to a position that will prevent the driveline from contacting the front edge of the rotary cutter deck when the rotary cutter is fully raised.

6. Operation

6.1 User Safety Training

Refer to “General Safety Instruction” on page 13 for user safety training requirements.

WARNING



Roll Away Hazard

Before leaving the tractor seat, make sure the engine is stopped, the transmission is placed in park, the key is removed, and the parking brake is set.



The weight of the tractor, plus the rotary cutter if it rolls onto a person, can cause serious crushing injury or death.



Crush Hazard

The tractor should be equipped with a Roll Over Protective Structure (ROPS) and a seat belt. A crushing hazard can occur if the driver is ejected from the seat while the tractor is in motion. Fasten the seat belt whenever the tractor is moving.

The rotary cutter is top heavy when the wings are raised. To avoid injury or death from rollover, use caution when transporting over uneven surfaces and slow down for turns.



Thrown Object Hazard

Cutters can throw objects up to 300 feet. To avoid serious injury or death:

- 1) Keep all thrown object shielding in place.
- 2) Inspect area for potential thrown objects before cutting.
- 3) Do not operate rotary cutter with the deck raised.



Thrown Object Hazard

For non-agricultural use, OSHA, ASAE, SAE, and ANSI standards require the use of chain guards or other protective guards at all times.



Stay Clear

Clear the work area of all unnecessary people and obstructions to prevent personal injury.



Cutter Blade Contact Hazard (hand)

To avoid serious injury or death, keep away from rotating blades. Do not put hands under cutter deck.



Cutter Blade Contact Hazard (foot)

To avoid serious injury or death, keep away from rotating blades. Do not put feet under rotary cutter deck.

WARNING



Crush Hazard

Hydraulic or mechanical failure can allow a wing to drop suddenly without warning. Do not allow anyone to walk under or stand near a raised wing when the uplock pins are removed.



Entanglement Hazard

Operating the rotary cutter without the driveline shields can result in physical injury or death from entanglement. Make sure all shields are properly installed before operating the rotary cutter. This equipment should never be operated with any safety shielding removed.

SAFETY INSTRUCTIONS

The following safety instructions are provided to help prevent injury or limit equipment damage.



Train Unfamiliar Users

It is the rotary cutter owner's responsibility to make sure any person using the rotary cutter, especially if it is loaned or rented, has been thoroughly trained on its proper and safe use.

Be certain only physically-able persons will use the rotary cutter.

Users who have not read and understood all operating and safety instructions are not qualified to use the rotary cutter.

If the elderly are assisting with the work, their physical limitations need to be recognized and accommodated.

Never allow children to operate equipment.



Fire Hazard

Clippings are flammable. To reduce the risk of fire:

- 1) Do not operate near fires.
- 2) Keep the rotary cutter deck clear of clippings and debris.

NOTICE

Wing cutting blades may become locked together (overlapped) when the wings are raised for transport. Operating the cutter in this condition will result in severe deck vibration. Inspect the wings for locked blades prior to lowering the wings. Use a pry bar or other tool to free any locked blades.

6.2 Tractor Requirements



WARNING



Tractor Owner/Operator Manual

Always refer to the tractor owner's manual to ensure compatibility and maximum safety.

The tractor used to operate the cutter must have the power to lift, pull, and operate the Power Take Off (PTO) at the cutter's rated speed while traveling at a ground speed between 2 and 5 MPH.

The power required to operate the cutter is determined by the tractor PTO horsepower. Operating the cutter with a tractor that does not have adequate power may damage the tractor engine.

Model	Recommended Min. HP
3515	60

Operating the cutter with a tractor that does not meet the following requirements may cause tractor or cutter damage and be a potential danger to the operator and passersby.

Always review the "controls" section of the tractor operator's manual to be familiar with the location, settings, and function of the tractor controls. Be familiar with all controls before using this equipment.

6.2.1 Equipment and Capabilities

- Approved Roll-Over Protective Structure (ROPS) or ROPS cab and seat belt.
- Tractor Safety Devices; Slow Moving Vehicle (SMV) emblem, lighting, PTO master shield.
- Front end weight, as needed, to maintain 20% weight on front axle.
- To reduce the risk of grass fires, do not operate the cutter on a tractor with an underframe exhaust.

6.2.2 Tractor Safety Devices

If transporting or operating the tractor and implement near a public roadway, the tractor must be equipped with proper warning lighting and a Slow Moving Vehicle (SMV) emblem which are clearly visible from the rear of the unit. Lights and a SMV emblem must be attached directly to the implement if the visibility of the tractor warning signals are obscured.

Maintain all manufacturer equipped safety shields and guards. Always replace shields and guards that were removed for access to connect, service, or repair the tractor or implement. Never operate the tractor PTO with the PTO master shield missing or in the raised position.

6.2.3 ROPS and Seat Belt

WARNING



Rollover Hazard

To avoid serious injury or death from falling off tractor, equipment runaway, rollover, or crushing:

- 1) Use ROPS equipped tractor.
- 2) Keep ROPS locked in the UP position.
- 3) Only operate the equipment when seated in the tractor seat.
- 4) Always fasten seat belt when operating the tractor and rotary cutter.
- 5) The unit is top heavy when the wings are folded. Use caution when transporting over uneven terrain and slow down for turns.

The tractor must be equipped with a Roll Over Protective Structure (ROPS) (tractor cab or roll bar) and seat belt to protect the operator from falling off the tractor, especially during a roll-over where the driver could be crushed and killed. Only operate the tractor with the ROPS in the raised position and seat belt fastened.

6.2.4 Power Take-Off (PTO)

This rotary cutter is available in versions to operate at a PTO speed of 540 RPM or 1000 RPM. Most tractors operate at either 540 or a combination of 540 and 1000 RPM PTO speeds. The operating speed of the rotary cutter and tractor can be determined by the number of splines on the driveline yoke and PTO output shaft. Those operating at 540 RPM will have a 6-spline shaft, and those operating at 1000 RPM will have a 20 or 21-spline shaft.

Refer to the tractor Operator's Manual for instructions to change PTO speeds on models that operate at more than one speed.

If operating an older model tractor where the tractor's transmission and PTO utilize one master clutch, an over-running clutch must be used between the PTO output shaft and the driveline of the rotary cutter. An authorized tractor dealer can provide the over-running clutch and its installation, if needed.

DO NOT use a PTO adapter to attach a non-matching implement driveline to a tractor PTO. Use of an adapter can double the operating speed of the implement, resulting in excessive vibration, thrown objects, and blade and implement failure. Adapter use will also change the working length of the driveline exposing unshielded driveline areas. Serious bodily injury and/or equipment failure can result from using a PTO adapter. Consult an authorized dealer for assistance if the implement driveline does not match the tractor PTO.

6.2.5 Drawbar

The distance between the drawbar hitch pin hole and the end of tractor PTO shaft must be set according to the PTO operating speed. The distance from the top of the drawbar to the PTO shaft must be 8". PTO damage may occur if these dimensions vary more than 1".

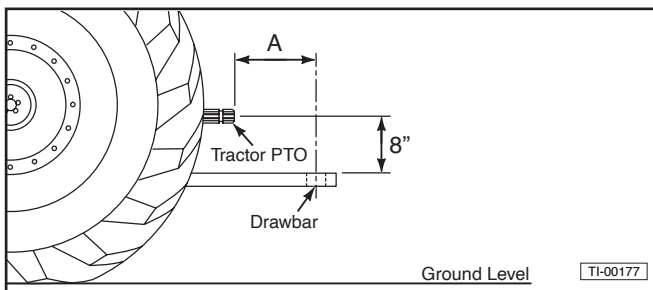

DRAWBAR LENGTH CHART	
PTO	Dimension A
540 RPM	14"
1000 RPM, 21 spline, 1-3/8" shaft	16"
1000 RPM, 20 spline, 1-3/4" shaft	20"

6.3 Attaching to Tractor

Use caution when connecting the rotary cutter to the tractor. The rotary cutter should be securely resting at ground level or setting on blocks. Keep hands and feet from under the deck and clear of pinch points between the tractor drawbar and rotary cutter hitch.

WARNING



Crush Hazard

Crush hazard between hitch and implement. Do not allow anyone to stand between the hitch and implement during hook-up operations.

1. Use the jack to adjust the hitch to the height of the tractor drawbar.
2. Board the tractor and start the engine. Back the tractor up to the cutter hitch until the holes in the drawbar and clevis are aligned.
3. Turn off the tractor engine and dismount.
4. Insert a 3/4" or larger high strength drawbar pin through the clevis and drawbar holes and install retaining pin. Do not use a homemade or shop made pin.
5. See diagram for correct hitch clevis orientation.



HITCH SUPPORT IS UP

CLEVIS HINGE IS UP

DUCK BILL IS DOWN

WARNING



Crush Hazard

Unexpected separation of the cutter from the tractor can cause death or serious injury. Use only an OEM high strength drawbar pin. Do not use a homemade or shop made pin.

5. Connect the hitch safety chain to the tractor drawbar cage.
6. Retract the jack, remove the locking pin, move the jack to its storage location on the cutter deck, and secure it with the locking pin.
7. Pull back on collar (1) on the tractor end of the driveline.

8. Push the driveline onto the tractor PTO shaft until the collar snaps forward.

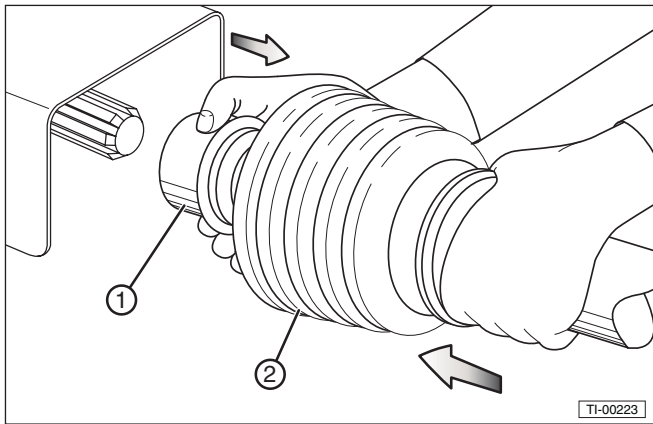

9. Pull back on driveline guard (2) to check that the driveline is latched. Do not pull back on the collar, as this will release the driveline.
10. Attach the safety chain on the driveline guard to the tractor.

WARNING



Entanglement Hazard

Operating the tractor PTO without the driveline shields can result in physical injury or death from entanglement. Make sure all driveline shields are properly installed before operating the PTO. Make sure all motion has stopped before attaching or detaching the driveline.

11. Inspect the hydraulic hoses to ensure they are in good condition and clean the fittings. Route the hydraulic hoses through the hose rack and attach to the tractor's hydraulic ports. Make sure the hoses are adequately supported so they cannot come in contact with other parts or the ground.
12. Make sure the driveline has adequate clearance through the full range of cutter height adjustment. Adjust tractor drawbar height and/or length if there is interference. See "6.2.5 Drawbar" on page 33 for correct drawbar dimensions.

6.4 Setting the Rotary Cutter

Properly setting the rotary cutter is essential for efficient and safe operation. A properly set rotary cutter will make a more uniform cut, distribute clippings more evenly, require minimal tractor work, and follow the contour of uneven terrain. The two adjustments to make before cutting are:

- Leveling front-to-back
- Cutting height

Note: Avoid very low cutting heights. Striking the ground with the blades causes damaging shock loads and will cause damage to the rotary cutter and drive. Blades contacting the ground may cause objects to be thrown out from under the cutter deck. Avoid operating the rotary cutter at a height which causes the blades to contact the ground.

6.4.1 Leveling Front-to-Back

1. Locate the tractor and cutter on a flat, level surface and use the hydraulics to adjust the cutter height until the front skid shoes are two to three inches off the ground.
2. Shorten or lengthen the leveling rods, as needed, until the front of the deck is level with the rear of the deck. Lengthening the leveling rods raises the back of the cutter.
 - a. Operating the rotary cutter with the deck approximately 3/4" higher in the rear than the front will allow the rotary cutter to cut the grass only once and requires less work from the tractor.
 - b. Operating the rotary cutter with the deck approximately 3/4" higher in the front than the rear will increase mulching of the grass or crop material.
 - c. Operating the rotary cutter at any position other than level with the ground will result in a slightly uneven cut.
3. Adjust the leveling rods to have equal amounts of tension.

6.4.2 Setting the Cutting Height







The rotary cutter should be operated at the highest position, which will give the desired cutting results. This will help prevent the blades from striking the ground, increasing blade life, and reducing stress on the rotary cutter and tractor.



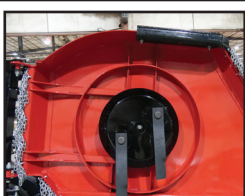

1. Park the tractor and rotary cutter on level ground.
2. Using the tractor hydraulic cylinder control lever, position the front of the rotary cutter with the side skids 1" lower than the desired cut height. For example, for a 3" cut, position the skids 2" from the ground. Set the control lever stop at this position to maintain this height when raising and lowering the cutter.

6.5 Initial Setup Checklist

Efficient and safe operation of the rotary cutter requires that every user read and understand the operational instructions and all related safety instructions outlined in this manual.

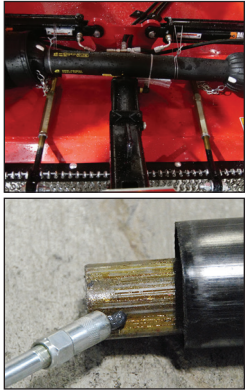
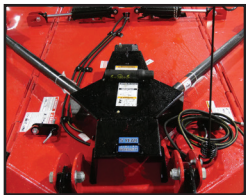
This checklist is provided for the user/owner. It is important for both personal safety and to maintain the mechanical condition of the rotary cutter that this checklist is followed.

Initial Setup Checklist (prior to using for the first time)		
✓	Location	Task
		Verify all safety signs are in place and legible. Refer to "3.3 Safety Sign Locations" on page 19.
		Make sure the rotary cutter is properly attached to the drawbar. Refer to "6.3 Attaching to Tractor" on page 33.
		Make sure the driveline is attached to the tractor PTO, and safety chains are installed. Refer to "6.3 Attaching to Tractor" on page 33.
		Make sure all hardware is properly installed and tightened. Refer to "9.11 Bolt Torque Requirements" on page 50.
		Check that the blades are sharp. Refer to "9.6 Blade Servicing" on page 47.
		Make sure the blade carrier nuts are tight and the cotter pins installed. Refer to "9.7 Blade Carrier Removal" on page 48.

Initial Setup Checklist (prior to using for the first time)		
✓	Location	Task
		Lubricate all grease zerks and driveline slip joints. Refer to "9.3 Greasing" on page 46.
		Make sure all safety shields and guards are properly installed. Refer to "5.2 Assembly Procedure" on page 24.
		Check the gearbox grease level. Refer to "9.4 Gearbox Lubrication" on page 47.
		Check the tailwheels for damage. Make sure the tailwheel support bolts are tight.
		Check the cutting height. Adjust if needed. Refer to "6.4.2 Setting the Cutting Height" on page 35.

6.6 Machine Break-In

Although there are no operational restrictions on the rotary cutter when used for the first time, it is recommended that the following mechanical items be checked:

1. After 1/2 hour of operation:
 - a. Tighten all fasteners if necessary.
 - b. Lubricate all grease fittings.
2. After 10 hours of operation:
 - a. Go to the normal servicing and maintenance schedule, as defined in the Maintenance Section.

6.7 Pre-Operation Checklist

Before each use of the rotary cutter, the following areas should be checked.

Checklist Before Each Use	
☐	Task
	Make sure the rotary cutter is positively attached to the tractor drawbar. Refer to "6.3 Attaching to Tractor" on page 33.
	Make sure the hydraulic hoses are undamaged, are secured on the hose rack, and cannot contact the tractor when turning or drag on the ground.
	Use only an appropriately-sized tractor to pull the rotary cutter. Refer to "6.2 Tractor Requirements" on page 32.
	Make sure the driveline is attached to the tractor PTO. Refer to "6.3 Attaching to Tractor" on page 33.
	Make sure all safety shields and guards are properly installed.
	Check the blade bolts and blade pan nuts. Refer to "9.6 Blade Servicing" on page 47.
	Inspect wing blade carriers and blades for locked blades prior to lowering the wings. Use a pry bar or other tool to separate locked blades.
	Check the condition of the blades.
	Check the cutting height. Adjust if needed. Refer to "6.4.2 Setting the Cutting Height" on page 35.
	Inspect the overall rotary cutter for potential problems or damage. Do not use the rotary cutter if it needs repairs of any type.
	Make sure the driveline CV joint, U-joints, and slip joints are greased. Refer to "9.5 Driveline Lubrication" on page 47.

6.8 General Operating Procedure

Although the rotary cutter is easy to use, each operator should review this section to familiarize themselves with the detailed safety and operating procedures.

1. Operate the rotary cutter only in conditions where you have clear visibility in daylight or with adequate artificial lighting. Never operate the rotary cutter in darkness or foggy conditions where you cannot clearly see at least 300 feet in front and to the sides of the tractor and rotary cutter. Make sure that you can clearly see and identify passersby, steep slopes, ditches, drop-offs, overhead obstructions, debris, and foreign objects. If you are unable to clearly see these type of items, discontinue operating the cutter.
2. Clear the area of bystanders, especially small children.
3. Clear the area to be cut of stones, branches, debris, and any hard objects that may be thrown. Never operate the rotary cutter in an area that you have not inspected and removed debris or foreign material. Mark the location of objects that cannot be removed.
4. Do not operate the rotary cutter, or drive the tractor into material that is burning, or areas that recently burnt and may contain hot spots. Burning material, sparks, and coals could be thrown from the rotary cutter to areas of vegetation that might ignite. Tire damage can occur when driving over hot material. Oil and grease on the tractor and rotary cutter could ignite, resulting in equipment destruction. Carry a fire extinguisher on the tractor at all times to extinguish possible fires encountered. Do not operate the rotary cutter on a tractor with an underframe exhaust.
5. Raise the rotary cutter fully and remove the transport lock. Fasten the transport lock around a leveling rod to prevent its loss. Lower the rotary cutter to operating height.
6. Remove the wing uplock pins and replace them in the storage location. Lower the wings.
7. Engage the PTO at low engine RPM, then raise PTO speed to 540 or 1000 RPM, as appropriate.
8. Begin cutting at a slow speed, then increase to a speed that gives a clean cut without lugging the engine. Do not operate above 5 MPH.
9. Never allow blades to contact solid objects like rocks, posts, wire, curbs, guardrails, or the ground while mowing.

10. When you get to the end of a pass, slightly raise the rotary cutter (2-4") before turning. Never raise the rotary cutter entirely while the blades are turning. If the rotary cutter must be raised higher than 12" from ground level, disengage the tractor PTO and wait for all blade rotation to come to a complete stop before proceeding to raise the rotary cutter.
11. When turning, the angle between the tractor and rotary cutter must not exceed 80°. This extreme angle is intended for intermittent use only. Plan your cutting to minimize extreme turning angles. Sharp turns can cause premature failure of the joints and put pressure on the tractor PTO shaft, and could cause extensive mechanical damage to the rotary cutter and tractor.
12. Large, dense, or wet vegetation may need to be cut in two or more passes to achieve a uniform cut. In such conditions, raise the cutting height to 12" or more on the first pass. Then lower the rotary cutter to the desired height and mow the vegetation a second time. If possible, select a cutting direction that is at a 90 degree angle to the first pass to reduce streaking for a more uniform cut.
13. Stay alert and watch for trees, low hanging limbs, power lines, and other overhead obstacles while operating. Use care to avoid hitting these items.
14. Avoid cutting in reverse. Instead, disengage the PTO, wait for the blades to stop, and raise the deck. Back up into the area to be cut. Lower the deck, engage the PTO, and cut forward. Do not back the rotary cutter into solid objects. The joint where the hitch attaches to the deck will pivot upward, allowing the front edge of the deck to contact the driveline. Check to make sure there are no persons behind the rotary cutter, and use extreme care when maneuvering in reverse.
15. Always cross steep ditches and banks at a diagonal. Never cross straight across and never back into a steep ditch or bank. Cutting over ditches and backing up hills can "Bottom Out" the driveline. Bottoming out is when the driveline shaft has shortened to the point it is pressing against the gearbox and tractor PTO shafts. Once a driveline has bottomed out, it cannot be shortened anymore without causing serious damage to the tractor PTO components, cutter gearbox, and driveline.
16. Do not operate a pull-type cutter at an angle exceeding 25 degrees up or down or at any angle that will force the driveline to bind and/or hit the tractor drawbar.
17. Whenever using a rotary cutter in dry grass, be aware that a thrown metal object can create a spark against the blade or metal deck housing. Take extra precautions in this type of dry situation to prevent fires.

6.9 Chain Shielding

IronCraft installs full chain shielding as standard equipment on all flex-wing rotary cutters.

WARNING



Projectile Hazard

The chain shielding is designed to reduce the risk of thrown objects.

The rotary cutter deck and protective devices cannot prevent all objects from escaping the blade enclosure in every mowing condition. It is possible for objects to ricochet and escape, traveling as much as 300 feet.

Death or serious injury can result from being struck by a thrown object. Do not operate the cutter if the chain shielding is missing or damaged.

1. Full chain shielding must be installed when operating in populated areas or other areas where thrown objects could injure people or damage property.
2. If the chain shielding is missing or damaged, operation must be stopped until it can be repaired or replaced.
3. Inspect chain shielding each day of operation and replace any broken or missing chains, as required.

6.10 Right of Way (Roadway) Mowing

Use double chain guards for highway, right-of-way, parks, greenbelt mowing, or all other mowing where human dwellings, vehicles, or livestock could be within 300 feet of the cutter.

No shielding is 100% effective in preventing thrown objects. To reduce the possibility of injury:

1. Maintain rotary cutter shielding in good operational condition.
2. Inspect the condition of the thrown object guards, cutter side skirts, and skid shoes daily: Replace or repair worn or damaged guards.
3. Inspect the condition of the blades and blade bolts daily. Replace any cracked, worn, bent, or damaged blades. Always replace blade bolts and lock washers when replacing blades. Make sure the blade bolts are properly tightened.
4. Raise cutting height to 6" minimum.
5. Never allow blades to contact solid objects like rocks, posts, wire, curbs, guardrails, or the ground while mowing.

Rotary cutters can throw objects 300 feet or more under certain conditions. To avoid serious injury or death from thrown objects:

1. Inspect the area thoroughly for potential thrown objects and remove them before cutting.
2. Remove debris, rocks, wire, cable, metal objects, and other foreign material from the area.
3. Wire, cable, rope, chains, and metal objects can be thrown or swung outside the deck with great velocity.
4. Mark the location of objects that cannot be removed.

Stop mowing if passersby are within 300 feet unless:

1. All thrown object shielding, including front and rear deflectors, chain guards, steel guards, bands, side skirts, and skid shoes are in place and in good condition when mowing.
2. Mower sections or wings are adjusted to be close and parallel to ground without exposing blades.
3. Mowing area has been inspected and foreign materials and debris have been removed.
4. Passersby are inside an enclosed vehicle.

6.11 Detaching From Tractor

1. Disengage the PTO and wait for blade rotation to come to a complete stop. Raise the rotary cutter with the tractor hydraulics, and install the transport lock on the lift cylinder.

NOTICE

Make sure the blades have completely stopped before raising the wings for transport. Gearbox and driveline damage may result if the blades are turning when the wings are raised.

2. Raise the wings with the tractor hydraulics and install the wing lock pins.
3. Park the tractor, place the transmission in park or neutral, and apply the parking brake. Lower the rotary cutter onto blocks placed under the front skid shoes. Shut down the engine, remove the key, and move the cylinder operating levers in both directions to relieve hydraulic pressure. Wait for all motion to come to a complete stop before exiting the tractor.
4. Make sure the rotary cutter is resting securely on the ground or blocks, and chock the wheels before attempting to disconnect it from the tractor. Use extreme care to keep feet and hands from under the rotary cutter and clear of any pinch points caused by the tractor drawbar and rotary cutter hitch.
5. Remove the jack from the cutter deck and secure it to the hitch by fully inserting the locking pin through the jack and the hitch bracket. Use the jack to raise the cutter hitch to the height needed to disconnect the clevis from the drawbar.
6. Disconnect the hydraulic hoses from the tractor. Store the hoses on the cutter deck.

CAUTION



Explosive Separation Hazard

Be sure all hydraulic pressure is relieved before disconnecting hydraulic lines or fittings between the rotary cutter and the tractor hydraulic system.

7. Disconnect the driveline safety chain and hitch safety chain.
8. Pull back on the collar on the tractor end of the driveline.

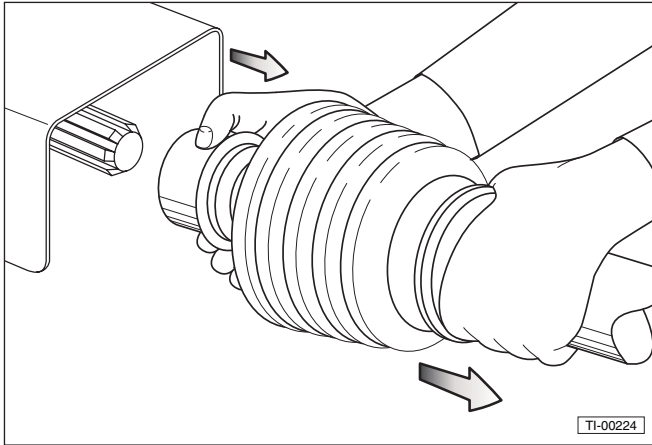

9. Slide the driveline off the tractor PTO shaft and secure it up off the ground.
10. Remove the hitch pin and drive the tractor away from the rotary cutter.

7. Transporting

7.1 Transporting Safety (Road)

WARNING



Failure to understand and follow these safety instructions can and will result in serious injury and possibly even death.

 **Tractor Owner/Operator Manual**
Always refer to the tractor owner's manual to determine its compatibility and maximum safety.



 **Operating the Tractor**
Before attaching the rotary cutter to the tractor, be familiar with its controls and how to stop it quickly in the event of an emergency. Read and understand this manual and the one provided with your tractor before transporting the rotary cutter.

 **Fall and Crush Hazard**
Do not allow riders on the rotary cutter or tractor.

 **Maximum Transporting Speed**
Do not exceed 15 MPH when transporting the rotary cutter. Slow down for corners and rough terrain.

  **Visibility**
Clean reflectors, SMV or SIS sign, and lights before towing. Make sure all the lights and reflectors required by highway and transport authorities are in place and can be seen clearly by all overtaking and oncoming traffic.

 **Regulations**
Make sure all local, state, and federal regulations, regarding the transport of equipment on public roads and highways, are met. Check with the local authorities regarding transporting the rotary cutter on public roads. Obey all applicable laws and regulations.

  **Rollover Protection**
The tractor should be equipped with a Roll Over Protective Structure (ROPS) and a seat belt.
The unit is top heavy when the wings are folded. Use caution when transporting over uneven surfaces and slow down for turns.

 **Thrown Object Hazard**
Before transporting, make sure the PTO is disengaged and all blade movement has stopped.

SAFETY INSTRUCTIONS

The following safety instructions are provided to help prevent injury or limit equipment damage.

 **Drive Safely**
Be a safe and courteous driver. Anticipate what other drivers will do and drive accordingly.

 **Allow Extra Distance**
Apply brakes early. Leave extra distance between your vehicle and the one(s) ahead to provide adequate stopping space. Extra distance will be required to stop the vehicle.

 **Clear Vision**
Remove all objects from the area that would prevent clear vision of the complete work area or would present an obstacle when moving the rotary cutter.

 **Hitch Attachment**
Be sure the rotary cutter is securely attached to the tractor and in good operating condition before using.

 **Working Taillights**
Make sure lights on the tractor are working properly.

 **Additional Lighting**
For rotary cutters without lights, install additional lights on the rear of the tractor to safeguard against rear-end collisions. Daybreak and dusk are particularly dangerous and rear pilot vehicles are recommended. Rotary cutters without lights should be transported on public roads only during daylight hours.

 **Hazard Flashers**
Use hazard flashers on the tractor when transporting unless prohibited by law.

 **Right-of-Way**
When travelling below the posted speed limit, keep to the right and yield the right-of-way to allow faster traffic to pass.

NOTICE

Laminated sectional tires are designed for conditions where puncture-proof performance is required and the rotary cutter will not be transported for long distances on roadways. Transport speed for laminated tires should not exceed 15 MPH. Excessive speed can cause damage to the machine and tire sections.

7.2 Transporting

1. Make sure the safety chain from the rotary cutter is attached to the tractor drawbar cage. The safety chain should be long enough for tight turns. Don't allow the chain to drag on the pavement because it will wear the chain links, causing an unsafe condition.
2. Prior to towing, make sure the brakes, brake lights, running lights, turn signals, and hazard lights on the tractor are operating correctly.
3. Raise the rotary cutter with the tractor hydraulics. Lower the transport lock onto the cylinder and insert the pin to lock the transport lock in place.

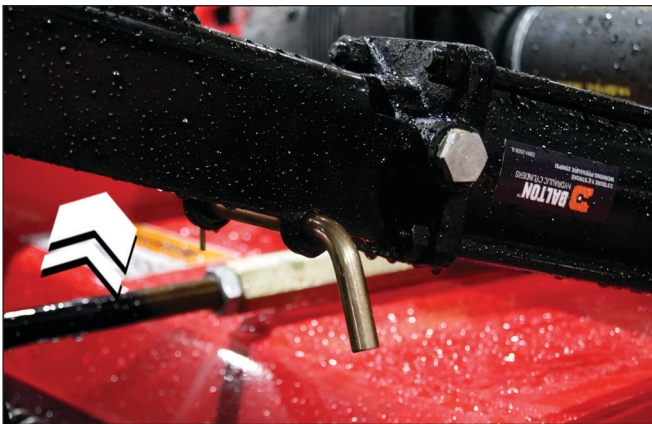

4. Make sure the jack stand is secured in the storage location.



5. Fold the wings onto the wing rests.



⚠ WARNING



Pinch Point Hazard

Do not place hands or fingers between moving and/or stationary parts. The weight of the unit will easily cause serious bodily injury.



Crush Hazard

When folding the wings, make sure to install both wing uplock pins.

6. Install the wing fold uplock pins and retaining pins.



7. Transport to the work site following all applicable regulations and all the safety instructions in this manual.

⚠ WARNING



Crush Hazard

The rotary cutter is top heavy when the wings are raised. To avoid injury or death from rollover, use caution when transporting over uneven surfaces and slow down for turns.

8. Storage

8.1 Storage Safety

At the end of the season, the rotary cutter should be thoroughly inspected and prepared for storage. Repair or replace any worn or damaged components to prevent any unnecessary downtime at the beginning of the next season.

WARNING



Rollover hazard

The rotary cutter is top heavy when the wings are raised. To avoid injury or death from rollover, store the cutter on a firm, level surface.

CAUTION



Personal Injury Hazard

Store the rotary cutter in an area away from human activity. To prevent the possibility of serious injury, do not permit children to play on or around the stored rotary cutter.

NOTICE

To prevent damage to the rotary cutter, store it in a dry, level area.

8.2 Placing In Storage

1. Remove all entangled vegetation.
2. Thoroughly wash the rotary cutter with a pressure washer or water hose to remove all clippings, dirt, mud, or debris.
3. Raise the rotary cutter with the tractor hydraulics, and install the transport lock on the lift cylinder.
4. Raise the wings with the tractor hydraulics and install the wing uplock pins and their retaining pins.
5. Select an area that is dry, level, and free of debris (inside a building is ideal). Move the rotary cutter to its storage area. Disconnect the rotary cutter from the tractor following the procedure in “6.11 Detaching From Tractor” on page 39.
6. Lubricate all grease points. Make sure all grease cavities have been filled with grease to remove any water residue from washing.
7. Touch up all paint nicks and scratches to prevent rusting.

8.3 Removing From Storage

1. Attach the rotary cutter to the tractor following the procedure in “6.3 Attaching to Tractor” on page 33.
2. Before placing the rotary cutter back into service, replace any worn or defective parts and perform the Pre-Operation Checklist.

NOTICE

Wing cutting blades may become locked together (overlapped) when the wings are raised for transport or storage. Operating the cutter in this condition will result in severe deck vibration. Inspect the wings for locked blades prior to lowering the wings. Use a pry bar or other tool to free any locked blades.

9. Service and Maintenance

9.1 Maintenance Safety

WARNING

Failure to comply with the following safety instructions can and will result in serious injury and possibly even death.



Personal Protection Equipment

Wear close fitting and belted clothing to avoid getting caught in moving parts. Wear personal protection equipment (PPE), which may include hard hat, safety glasses, safety shoes, gloves, etc. appropriate for the work site and working conditions.



Disconnect Driveline

To prevent injury due to possible unexpected movement, disconnect the driveline from the tractor PTO before performing any maintenance procedure.



Damaged Parts Hazard

Do not use the rotary cutter if any parts are damaged. If the rotary cutter is believed to have a defect which could cause it to work improperly, immediately stop using it and remedy the problem before continuing.



No Unauthorized Modifications

Do not modify the rotary cutter or safety devices. Do not weld on the unit. Unauthorized modifications may impair its function and safety and will void the warranty.

If the rotary cutter has been altered in any way from the original design, the manufacturer does not accept any liability for injury or warranty.



Crush Hazard

Always set the rotary cutter on safety stands or on the ground and chock the wheels when performing maintenance.



Good Working Condition

Keep all parts in good condition and properly installed. Fix damage immediately. Replace worn or broken parts.



Replacement Parts

If replacement parts are necessary, genuine factory replacement parts must be used to restore the unit to its original specifications. The manufacturer will not accept responsibility for damages as a result of the use of unapproved parts.

WARNING



Safety Shields and Devices

When completing a maintenance or service function, make sure all safety shields and devices are installed before placing the rotary cutter in service.



Crush hazard

The wings may drop unexpectedly if the uplock pins are not installed. To avoid serious injury or death from crushing, always make sure the uplock pins and their retaining pins are properly installed whenever the wings are raised.



The rotary cutter is top heavy when the wings are raised. To avoid injury or death from rollover, make sure the cutter is on a firm, level surface.



Trapped Air Hazard

When installing, replacing, or repairing hydraulic system cylinders or parts, make sure that the entire system is charged and free of air before resuming operations. Failure to bleed the system of all air can result in improper machine operation, causing severe injury.



Zero Pressure

Relieve pressure from the hydraulic system before servicing or disconnecting from the tractor.



Explosive Separation Hazard

Replace any worn, cut, abraded, flattened, or crimped hoses.



High-Pressure Hazard

Do not make any temporary repairs to the hydraulic lines, fittings, or hoses using tape, clamps, or cement. The hydraulic system operates under extremely high pressure and temporary repairs may fail suddenly and create a hazardous/dangerous situation.



High-Pressure Fluid Hazard

Keep all hydraulic lines, fittings, and couplers tightly secured and free of leaks.

DO NOT use your bare hand to check for potential leaks. Always use a board or cardboard when checking for a leak.

Escaping hydraulic fluid under pressure, even a pinhole size leak, can penetrate body tissue, causing serious injury and possible death. If fluid is injected into your skin, it must be treated immediately by a doctor familiar with this type of injury.

SAFETY INSTRUCTIONS

The following safety instructions are provided to help prevent injury or limit equipment damage.



Safety Equipment

A fire extinguisher and first aid kit should be readily accessible while performing maintenance on this equipment.



Clean Work Area

Do not leave tools lying around the work area. Follow good shop practices. Keep service area clean and dry. Be sure electrical outlets and tools are properly grounded. Use adequate light.



Use the Right Tools

Use the correct tools, jacks, hoists, or other tools that have the capacity for the job.



Proper Support

Use certified safety stands rated to support the load when working beneath the rotary cutter, or performing repairs, service, or maintenance.

The rotary cutter weighs 5200 lbs. Before working underneath, place it on a minimum of four jack stands, with a load rating of at least 3000 lbs. each.

Do not position the jack stands under wheels, axles, or wheel supports, as they may rotate and cause the rotary cutter to fall.

Make sure the jack stands are stable and the rotary cutter deck is approximately level. Test the stability of the rotary cutter before working underneath.

If the rotary cutter is attached to the tractor, set the brakes, remove the key, chock the tractor wheels, and block the rotary cutter before working underneath.

9.2 Welding Repairs



Before performing any type of welding repair to the rotary cutter, contact IronCraft for approval. Repair welding must be done with care and with procedures that may be beyond the capabilities of the ordinary welder.

WARNING



Projectile Hazard

Do not attempt to weld on the blades. They are hardened and will crack or otherwise be damaged, causing failure and possible serious injury or death from thrown blades.



Personal Injury Hazard

Repairs or modifications to the rotary cutter can result in serious injury or death should these repairs fail.

NOTICE

Anyone performing a welding repair should be certified in accordance to the American Welding Society (AWS) standards.

9.3 Greasing

See the diagram for the location of all grease zerks.

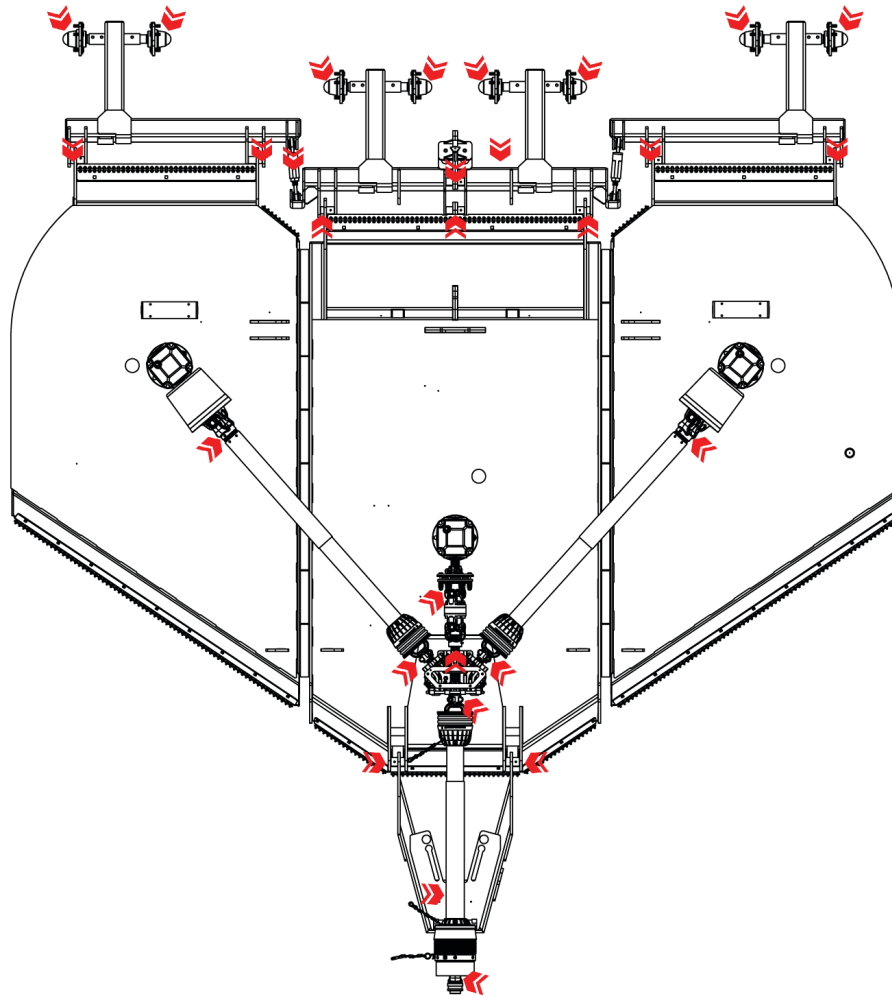

Location	Qty.
Receiver Swivel	1
Hitch Pivot Bushings	2
Front Driveline CV Joint	2
Front Driveline U-Joints	3
Wing Driveline U-Joints	4
Splitter Cross Shaft U-Joints	2
Tailwheel Hubs	8
Wing Turnbuckles	2

Use an SAE multipurpose high-temperature grease with extreme pressure (EP) performance. Also acceptable is an SAE multipurpose lithium base grease.

1. Always use a handheld grease gun for all greasing.
2. Wipe grease zerks with a clean cloth before greasing to avoid injecting dirt and grit.
3. Apply grease until new grease can be seen coming out of the joint.
4. Do not let excess grease collect on or around parts, particularly when operating in sandy areas.
5. Replace broken grease zerks immediately.
6. If any grease zerk will not take grease, remove and clean it thoroughly. Also clean the lubricant passageway. Replace the zerk if necessary.

9.4 Gearbox Lubrication

The gearboxes are filled at the factory. **Lubrication levels need to be checked by both the dealer and by the customer.** If there is evidence of leakage, the grease level should be checked. If required, grease should be added until it comes to the proper level. Recommended lubricant is SAE 140 Gearoil or Canned Substitute EP-0 Grease.

Splitter gearbox capacity is 58 ounces.
Outboard gearbox capacity is 49 ounces.

Note: Make sure the rotary cutter is level when checking the grease in the gearbox.

Note: Overfilling the gearbox will cause pressure to build up and cause the seals to leak.

9.5 Driveline Lubrication

Lubricate all driveline slip joints, U-joint crosses, and the center driveline CV joint before initial use and every eight operating hours thereafter.

1. Lower the rotary cutter to the ground, disconnect the center driveline from the tractor PTO shaft, and slide the halves apart but do not disconnect from each other.
2. Apply a bead of grease completely around male half where it meets female half. Slide drive halves over each other several times to distribute grease.
3. Disconnect the wing drivelines from the splitter gearbox and repeat Step 2 for each wing driveline.
4. Rotate the front driveline safety shield until the holes in the shield match up with the grease zerks in the CV joint and U-joint.
5. Apply grease to all accessible grease zerks.
6. Rotate the driveline shield 180° until the holes on the opposite side align with the remaining grease zerks, and apply grease.
7. Repeat for the U-joint at the rear of the center driveline, and at both ends of the wing drivelines.
8. Grease the zerks on the splitter cross shaft.
9. Re-connect the drivelines, close the front gearbox shield, and install the retaining pins.

9.6 Blade Servicing

Inspect blades before each use to determine that they are properly installed and in good condition. If any blade is bent, excessively nicked, worn, or has any other damage, replace both blades on the spindle. Small nicks can be ground out when sharpening.

Manually rock the blade carriers to check for any looseness. Recheck torque every fifty hours. Retighten any loose parts.

9.6.1 Blade Removal

To remove the blades for sharpening or replacement, remove the nut and lockwasher from the blade bolt through the inspection hole in the deck of the mower near the gearbox.



9.6.2 Blade Installation

When installing blades, be sure to check the blade bolt pivot diameter for wear. Replace the bolt if worn more than 1/4 inch at any point. Tighten nut to 600 ft. lbs.

Always use a new lockwasher and nut when replacing the blade bolt.

Make sure blades are installed with the cutting edge in the direction of rotation. The left and center spindles rotate counterclockwise as viewed from above the deck. The right spindle rotates clockwise as viewed from above the deck.

9.6.3 Blade Sharpening

CAUTION



Sharp Object Hazard

The grinder may catch on the blade during sharpening, propelling it forcefully. To prevent the possibility of serious injury, make sure blades are secured against movement while sharpening.

When sharpening blades, always sharpen both blades at the same time and grind the same amount on each blade to maintain balance. Unbalanced blades will cause excessive vibration, which can damage gearbox bearings. Vibration may also cause structural cracks to the rotary cutter. Follow the original sharpening pattern. Do not sharpen blades to a razor edge; leave a 1/16" blunt edge. Do not sharpen the back side of the blade. Do not heat and pound out the edge.

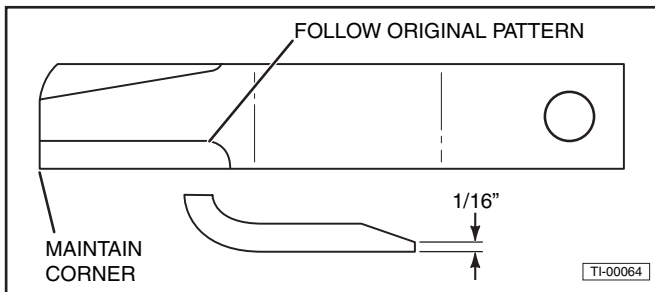

Replace the blades when worn more than 1/2" from the original edge. Always replace blades in pairs.

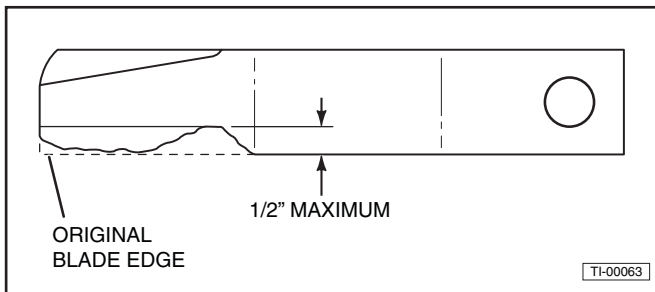

9.7 Blade Carrier Removal

1. Remove the cotter pin and loosen the castle nut on the gearbox shaft. Do not remove the nut until the blade carrier is loosened.
2. Use a suitable two jaw gear puller to pull the carrier off the tapered gearbox shaft.
3. If a gear puller is not available, insert a bar through the blade bolt access the hole with the end against the blade carrier. Strike the opposite end of the bar sharply. Rotate the blade carrier 180 degrees and repeat until the carrier breaks loose.
4. Remove the castle nut and the blade carrier.

9.8 Blade Carrier Installation

1. Clean the splines on both the blade carrier and the output shaft.
2. Position the carrier on the gearbox output shaft and install the castle nut. Tighten the nut to a minimum 450 ft. lbs.
3. Strike the carrier near the hub several times with a heavy hammer to seat the hub. Use care not to strike the nut or the end of the shaft.
4. Retighten the nut to 700 ft. lbs.
5. Install the cotter pin and spread the tangs.

9.9 Slip Clutch Operational Check

The rotary cutter is equipped with three slip clutches, with one located in front of each spindle gearbox. The slip clutches serve as overall protection for the tractor, driveline, and gearboxes. Even though new clutch assemblies are "run-in" and checked for torque prior to shipment, readjustment may be advisable if the clutch has been exposed to weather for an extended period of time. The clutch facing and plates should be inspected for rust and/or corrosion. After the rotary cutter has been stored for thirty days or more, perform the following check:

1. Make a trial run in the heaviest operating conditions expected. If any clutch slips noticeably, tighten the eight adjusting bolts no more than 1/2 turn between trial runs until the clutch slippage is reduced.
2. Scribe a mark across the clutch facing of each slip clutch. When subjected to shock loads, a separation of the marks will assure that the clutch setting is correct.

Note: Check the clutches periodically during the first hour of operation for excessive heat build-up due to unexpected slippage.

If a clutch is being rebuilt (new facing and/or plates), it is necessary to "run-in" these parts prior to final adjustment. The plates should be thoroughly cleaned and free of foreign material, as well as being checked for warping with a straight edge. Warped plates cannot be adjusted properly and will not hold. To accomplish the "run-in" after assembly, follow this procedure:

1. Tighten all the adjusting bolts evenly until the clutch cannot be slipped by hand.
2. With the blade carrier locked in a stationary position, operate with the PTO at idling speed (approximately 100 RPM), until evidence of heating is noted. **Do not allow the clutch to overheat.**

3. Discontinue operation and **allow the clutch to cool completely.**
4. After the clutch has cooled, tighten all the adjusting bolts evenly and proceed with the regular clutch adjusting procedures, as described above.

9.10 Slip Clutch Adjustment

The slip clutches are factory preset to the correct torque for protecting the implement and tractor. Periodic adjustment is recommended. Should adjustment be needed, follow this procedure:

1. Check to be sure all spring lengths are the same. Initial spring length is shown in the chart.

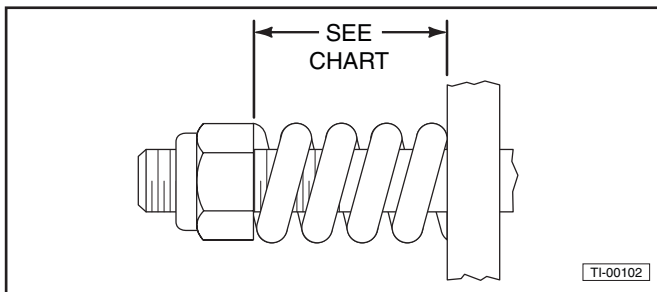

CLUTCH SPRING LENGTH CHART	
EG / COMER	BONDIOLI & PAVESI
1.27" (32.2mm)	1.15" (29.3mm)
1.28" (32.4mm)	1.12" (28.5mm)

2. If necessary, adjust the nut on any spring that is unequal. Adjust all eight spring retaining nuts 1/3 of a turn (two flats on a nut) and check clutch slippage.
3. If further adjustment is necessary, adjust in 1/3 turn increments. Adjust only to provide sufficient torque to prevent slippage under normal conditions. Occasional slippage is normal for drive train protection. If satisfactory results cannot be obtained, consult your authorized dealer.

NOTICE

Do not overtighten and cause the spring to become solid, as this will cause shaft failure.

9.11 Bolt Torque Requirements

It is extremely important to apply and maintain proper torque on all bolts. Use a torque wrench to assure the proper amount of torque is being applied to the fastener.

Start all bolts or nuts by hand to prevent cross threading.

Torque figures indicated in the chart are used for non-greased or non-oiled threads unless otherwise specified. Therefore, do not grease or oil bolts or cap screws unless otherwise specified in this manual. When using locking elements, increase torque values by 5%.

The chart gives correct torque values for various bolts and cap screws. Tighten all bolts to the torque specified in the chart unless otherwise noted. Check tightness of bolts periodically, using the bolt torque chart as a guide. Always replace hardware with the same Grade bolt.

Standard Torque Values

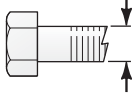
Bolt Diameter 	English Bolt Torque Specifications					
	Grade 2		Grade 5		Grade 8	
	N·m	ft.lbs.	N·m	ft.lbs.	N·m	ft.lbs.
1/4"	8	6	12	9	17	12
5/16"	13	10	25	19	36	27
3/8"	27	20	45	33	63	45
7/16"	41	30	72	53	100	75
1/2"	61	45	110	80	155	115
9/16"	95	60	155	115	220	165
5/8"	128	95	215	158	305	220
3/4"	225	165	390	290		398
7/8"	230	170	570	420	880	650
1"	345	225	850	630	1320	970

WARNING



EQUIPMENT FAILURE

The torque value for bolts and cap screws are identified by their head markings. Replacing higher "Grade" bolts (Grade 5) with lower Grade bolts will lead to equipment failure and can result in injury or death. Always use replacement bolts with the same Grade markings as the removed bolt.

9.12 Service Record

The period recommended is based on normal operating conditions. Severe or unusual conditions may require more frequent service.

Copy this page to continue record.

Hours and Serviced By																				
Maintenance																				
Every Use																				
Grease tailwheel zerks before every use.																				
Every 8 Hours																				
Make sure blade bolts are tightened to proper torque. Refer to "9.6.2 Blade Installation" on page 47.																				
Make sure all retainer clips and cotter pins are in place.																				
Inspect the cutting blades for wear and damage. Refer to "9.6.3 Blade Sharpening" on page 48.																				
Grease the driveline CV joint, U-joints and slip joints. Refer to "9.5 Driveline Lubrication" on page 47.																				
Every 50 Hours																				
Check blade carrier nut torque. Refer to "9.6.2 Blade Installation" on page 47.																				
Grease all lubrication points. Refer to "9.3 Greasing" on page 46.																				
Annually																				
Grease all lubrication points. Refer to "9.3 Greasing" on page 46.																				
Make sure all fasteners are properly tightened.																				
Check cutter deck, gearboxes, and driveline for damage.																				
Inspect the cutting blades for wear and damage. Refer to "9.6.3 Blade Sharpening" on page 48.																				
Make sure the hitch pivot bolts and hitch pin are in good condition. Do not use homemade or shop made pins.																				
Make sure the slip clutch is functioning properly. Refer to "9.9 Slip Clutch Operational Check" on page 48.																				
Inspect the hitch and clevis for wear and damage.																				
Wash the rotary cutter.																				

10. Troubleshooting

PROBLEM	CAUSE	SOLUTION
Uneven cut.	Excessive ground speed.	Reduce ground speed.
	Blades worn, dull, or bent.	Replace blades.
	Improper height adjustment.	Adjust rotary cutter height. Refer to "6.4.2 Setting the Cutting Height" on page 35.
	Low tractor tire pressure on one side.	Adjust tire pressure. (Refer to OEM manual).
	Turning too fast.	Reduce ground speed when turning.
	Tractor tires pushing grass down.	Adjust your tractor wheel spacing. (Refer to OEM manual).
	Damaged cutter pan.	Repair or replace as necessary.
Uncut material.	Excessive ground speed.	Reduce ground speed.
	RPM too low.	Maintain rated PTO RPM.
Windrowing.	Material heavy and lush.	Raise the front of rotary cutter relative to the rear. Refer to "6.4 Setting the Rotary Cutter" on page 34.
	Excessive ground speed.	Reduce ground speed.
	Conditions too wet.	Wait for conditions to dry. Reduce ground speed.
Grass cut lower in center of swath than at edge.	Height of rotary cutter lower at rear or front.	Adjust rotary cutter height and attitude so that rear and front are within 1/2" of same height.
Streaking conditions in swath.	Blades dull.	Sharpen or replace blades.
	Blades unable to cut that part of grass pressed by path of tractor tires.	Slow ground speed of tractor but maintain rated PTO RPM. Cutting lower will help.
	Conditions too wet for mowing.	Allow grass to dry before mowing.
Material discharges from cutter unevenly; bunches of material along swath.	Material too high and too much material.	Reduce ground speed but maintain rated tractor PTO RPM or make two passes over material. Raise rotary cutter for the first pass and lower to desired height for the second and cut at 90° to first pass. Raise rear of rotary cutter high enough to permit material to discharge but not so high as to cause conditions listed above.
	Grass wet.	Allow grass to dry before mowing. Reduce ground speed but maintain rated tractor PTO RPM. Cutting lower will help.
	Rear of rotary cutter too low, trapping material under cutter.	Adjust rotary cutter height and attitude.
Rotary cutter will not cut all the time.	Slip clutch slipping.	Adjust slip clutch. Refer to "9.10 Slip Clutch Adjustment" on page 49.
	Burnt or damaged clutch facing.	Rework clutch or replace according to OEM manual.
Blade bolts working loose.	Bolts not tightened.	Tighten bolts. Refer to "9.6 Blade Servicing" on page 47.
	Bolt hole elongated or oversized.	Replace blade carrier. Refer to "9.7 Blade Carrier Removal" on page 48.
	Lockwasher broken.	Replace lockwasher. Refer to "9.6 Blade Servicing" on page 47.
Gearbox noisy.	Low lubricant level.	Add grease. Refer to "9.4 Gearbox Lubrication" on page 47.
	Worn bearing.	Replace bearing.

Gearbox leaking.	Damaged oil seal.	Replace seal.
	Bent shaft.	Replace gearbox.
	Oil seal not sealing in the housing.	Replace seal or use a sealant on O.D. of seal.
	Oil level too high.	Drain to proper level.
	Gasket damaged.	Replace gasket.
	Bolts loose.	Tighten bolts.
Gearbox overheating.	Low on lubricant.	Fill to level plug.
	Improper type of lubricant.	Replace with proper lubricant. Refer to "9.4 Gearbox Lubrication" on page 47.
	Excessive trash build-up around gearbox.	Remove trash.
Excessive vibration.	Blades are not free to swing.	Check bushing and blade movement.
	Blades are out of balance.	Check blades for damage or replace blades. Refer to "9.6 Blade Servicing" on page 47.
Unusual noise.	Loose blade bolts or worn bushings.	Tighten bolts, check bushings for wear and change as needed. Refer to "9.6 Blade Servicing" on page 47.
	Bent blade carrier or blades.	Replace blade carrier or blades. Refer to "9.7 Blade Carrier Removal" on page 48.
	Deck bent, causing blades to contact deck.	Straighten deck.
Driveline will not telescope.	Improper lubrication.	Grease driveline. Refer to "9.5 Driveline Lubrication" on page 47.
	Driveline twisted.	Replace driveline. Caution operator not to strike ground with blades.
	Driveline bent.	Driveline too long. Replace and shorten to proper length. Refer to "5.5 Shortening the Driveline" on page 30.
	Shields damaged.	Replace shields.
Driveline twisted.	Over torqued.	Replace driveline. Caution operator not to strike ground with blades.
	Not maintaining correct PTO speed.	Maintain rated PTO RPM.

11. Warranty

IronCraft

LIMITED WARRANTY

IronCraft (the “Manufacturer”) warrants, only to the original Purchaser, this equipment will be free from defects in material and workmanship, under normal use and service, for one (1) year from the date of purchase providing this equipment is purchased for individual use only. **Commercial use of this equipment is not covered under any warranty.** This warranty does not apply to any equipment which has been damaged or which has been subjected to change, misuse, negligence, abnormal wear and tear, alterations, tampering, or failure to follow operating instructions. This warranty does not cover any product or parts not manufactured by IronCraft.

IronCraft rotary cutters have a five (5) year Limited Warranty* on gearbox components provided they have been properly maintained and have not been subjected to abuse or misuse except as limited below.**

***Gearbox warranty limitations:**

- i. Warranty is one (1) year for seals unless seals are damaged from debris wrapped around the input and or output shaft of the gearbox. After one year, seals are considered to be wearing parts, and the replacement is the owner’s responsibility.
- ii. Gearboxes that are subject to warranty may be replaced with new or rebuilt gearboxes at the discretion of IronCraft.
- iii. **Shearbolts must be approved Grade 2, 1/2” x 3” shearbolts.**

****NOTE: “properly maintained” specifically includes, but is not limited to:**

- i. Running gearboxes with the proper amount of correct lubricant.
- ii. Adjusting slip clutches correctly to provide proper protection for gearbox components and drive line.

Under this warranty, the Manufacturer will repair or replace any part which the Manufacturer determines has failed during the period of the warranty due to defects in material or workmanship. After written approval by the manufacturer, the equipment or defective part must be returned to IronCraft.

Warranty coverage and performance is expressly conditioned upon the return of the completed registration form to IronCraft, PO Box 968, Athens, Tennessee 37303.

IronCraft reserves the right to make improvements and changes in specifications without notice or obligation to modify previously sold units. The Owner’s Manual describes the proper assembly procedures for your implement and furnishes operating and maintenance recommendations to help you obtain long and satisfactory service.

PURCHASER’S EXCLUSIVE REMEDY FOR BREACH OF WARRANTY, OTHER DEFECT, OR CONDUCT GIVING RISE TO LIABILITY SHALL BE THE REPAIR OR REPLACEMENT OF THE PRODUCT SOLD, AND THE MANUFACTURER UNDER NO CIRCUMSTANCES SHALL BE LIABLE FOR ECONOMIC LOSS OR INCIDENTAL OR CONSEQUENTIAL DAMAGES. THE MANUFACTURER DISCLAIMS ALL IMPLIED WARRANTIES, INCLUDING THE WARRANTY OF MERCHANTABILITY AND FITNESS FOR PURPOSE.

Purchaser and IronCraft hereby (a) submit to the non-exclusive jurisdiction of the courts of competent jurisdiction in Meigs County, Tennessee, and the United State District Court for the Eastern District of Tennessee for resolution of any dispute concerning this Limited Warranty or the rights or obligations of Purchaser and/or IronCraft; (b) agree that any litigation commenced in Tennessee in connection with this Limited Warranty shall be venued in either the Meigs County, Tennessee District Court, or the United States District Court, Eastern District of Tennessee, Southern Division, and (c) waive any objection it may have as to any such action or proceeding brought in such court that such court is an inconvenient forum. Nothing herein shall limit the right of Purchaser or IronCraft (or the right of any permitted successor or assign of either) to bring proceedings against the other in the courts of any other jurisdiction wherein any assets of such other party may be located.



WARRANTY REGISTRATION FORM

3515 FLEX-WING ROTARY CUTTER

THIS REGISTRATION FORM MUST BE ON FILE WITH IronCraft.
WITHIN **30 DAYS** OF DELIVERY TO PURCHASER, OR WARRANTY CLAIM WILL NOT BE HONORED.

PLEASE COMPLETE REGISTRATION ONLINE

OR RETURN COMPLETED FORM BY E-MAIL, FAX, OR MAIL:

E-MAIL: warranty@ironcraftco.com

FAX: (423) 334-0023

MAIL: PO BOX 968, ATHENS, TN 37303

MODEL: _____ SERIAL #: _____ DELIVERY DATE: _____

TRACTOR MAKE & MODEL BEING USED WITH ABOVE UNIT: _____

PURCHASER'S NAME: _____

ADDRESS: _____

CITY: _____ STATE: _____ ZIP: _____

SELLING DEALER'S NAME: _____

CITY: _____ STATE: _____ ZIP: _____

I have read all warranties and agree with these conditions. I agree to read and follow all safety instructions outlined in this manual before operating this rotary cutter.

Purchaser's signature: _____

Cut Here to Remove Page or Make Copies of This Page



**P.O. BOX 968
7 ROCKY MOUNT ROAD
ATHENS, TENNESSEE 37303
PHONE: (423) 405-5150 ■ FAX: (423) 334-0023
WEB: www.IRONCRAFTCO.com**

Member of

