



CID

ATTACHMENTS

STUMP GRINDER

STG1727

STG2030

STG3044

OWNER'S MANUAL



OCT
2024

OPERATING INSTRUCTIONS | SAFETY RULES | MAINTENANCE PROCEDURES

REGISTER YOUR PRODUCT

CID

336-859-2002

MODEL

WEIGHT

PART

HP RANGE

SERIAL

HYDRAULIC PRESSURE

HYDRAULIC FLOW

WWW.CIDATTACHMENTS.COM

Please see the inside of the back cover for instructions of where to find your model and serial number.

WARNING

To prevent personal injury or even death, be sure you read and understand all the instructions in this manual and other related OEM equipment manuals! This attachment if not used and maintained properly, can be dangerous to users unfamiliar with its operation. Do not allow operating, maintaining, adjusting, or cleaning of this attachment until the user has read this manual and has developed a thorough understanding of the safety precautions and functions of the unit. This attachment is designed for the purpose specified. DO NOT modify or use this attachment for any application other than that for which it was designed. Attachments maintained or operated improperly or by untrained personnel can be dangerous, exposing the user and/or bystanders to possible serious injury or death.

**STORE THIS MANUAL IN THE
DOCUMENT CANISTER ATTACHED
TO THIS MACHINE.**



Purchase Date:

Dealer Name:

Address:

Phone Number:

WELCOME

Thank you for choosing CID. This attachment has been designed and manufactured to meet the needs of discerning users. We are committed to providing you with a heavy duty product that will provide years of satisfaction and safe operation.

This manual will provide instructions on how to safely operate and maintain this attachment. All users must read and understand this manual before operating this machine. Upon reading this manual, all users should sign the “Safety Acknowledgment Form” at the end of this manual.

Please record your model and dealer information on the inside front cover. You will be asked to provide this information when ordering parts or requesting service. If you need more information on this product, contact your local dealer or visit www.cidattachments.com.

Sincerely,
The CID Team



MODELS	STG1727	STG2030	STG3044
TEETH QTY	30	30	30
MOTOR	RADIAL PISTON	PARKER BENT AXIS PISTON	RADIAL PISTON
GPM	17-27	20-30	30-44
WEIGHT	850 LBS	850 LBS	850 LBS
TEETH TYPE	900 SERIES WEAR-SHARP GREEN TEETH	900 SERIES WEAR-SHARP GREEN TEETH	900 SERIES WEAR-SHARP GREEN TEETH
CASE DRAIN	NOT REQUIRED	REQUIRED	REQUIRED
WHEEL DIAMETER	27.5 INCH	27.5 INCH	27.5 INCH
FITS ON	SKID STEER	SKID STEER	SKID STEER

TABLE OF CONTENTS

INTRODUCTION	3
WARRANTY DISCLAIMERS	5
SECTION 2 SAFETY INFORMATION	
2.1 Safety Terms.....	6
2.2 Safety Symbols.....	7-8
2.3 Safety Decals.....	9-10
2.4 Skid Steer Loader Requirements.....	11
2.5 Personal Protective Equipment Requirements.....	11
2.6 General Safety Instructions.....	12
2.7 Federal Laws & Regulations.....	13
SECTION 3 OPERATING PROCEDURES	
3.0 Unpacking Your Stump Grinder.....	14
3.1 Pre-Operating Checklist.....	14
3.2 How to Connect Stump Grinder Attachment.....	15-16
3.3 Stump Grinder Controls.....	16
3.4 How to Disconnect Stump Grinder.....	17
3.5 Hydraulic System.....	17-18
3.6 Digging Preparation.....	18
3.7 Prepping For First Time Use.....	19
3.8 Learning Your Attachment.....	19-20
3.9 Before Starting.....	20
3.10 Determining the Proper Grinding Process.....	21
3.11 Determining the Hardness of the Wood.....	21-22
3.12 Navigating with the Stump Grinder.....	22
3.13 Grinding Instructions.....	23-24
3.14 Operating Guidelines.....	24
SECTION 4 MAINTENANCE PROCEDURES	
4.0 Maintenance Overview.....	25
4.1 Maintenance Schedule.....	26-27
4.2 Torque Specification Table & Instructions.....	28
4.3 Equipment Requirements.....	28
4.4 Maintenance Log Instructions.....	29
4.5 Storage Tips.....	29
4.6 Blade Safety.....	30
4.7 Tooth Holder Inspection & Replacement.....	30
4.8 Tooth and Tooth Holder Torque Specs.....	31
4.9 Tooth Inspection & Replacement.....	32-33
4.10 How to Replace Rubber Chip Guard.....	34
4.11 How to Replace Chip Guard Frame.....	34
4.12 How to Replace the Motor Protector Frame.....	35
4.13 Gearbox and Drive Bearing Housing Maintenance.....	35-36
SECTION 5 TROUBLESHOOTING	
5.0 Troubleshooting Chart.....	37
SECTION 6 SPECIFICATIONS	
6.0 Specifications Chart.....	38

SECTION 7 PARTS INFORMATION

7.0	Parts Information Form.....	39
7.1	Stump Grinder Blade Assembly Diagram.....	40
7.2	Stump Grinder 17-27 GPM Parts Diagram.....	41
7.3	Stump Grinder 20-30 GPM Parts Diagram.....	42
7.4	Stump Grinder 30-44 GPM Parts Diagram.....	43

SECTION 8 WARRANTY INFORMATION

8.0	Warranty Statement.....	44-45
8.1	Warranty Return Authorization Policy.....	45
8.2	Warranty Procedure.....	46

SECTION 9 SAFETY ACKNOWLEDGMENT FORM.....47

SECTION 10 MAINTENANCE LOGS.....48-50

APPENDIX A FINDING YOUR MODEL AND SERIAL NUMBER.....51



IMPORTANT WARRANTY DISCLAIMERS

ATTENTION: If your attachment has control valves, cylinders, gearboxes, or motors and they are opened or disassembled, the **WARRANTY for that item WILL IMMEDIATELY BE VOIDED!**

GEAR OIL STATEMENT: *If applicable in your attachment, check gear oil before each use:*

We recommend using 85-140 grade gear oil, for use with all our gear boxes, and bearing housings which is separate from the hydraulic fluid used to move your attachment or machine.

(Exception: gear oil used in mulchers is Shell Omala S2 GX 150!)

HYDRAULIC FLUID STATEMENT: Check your machine’s hydraulic level and add hydraulic fluid if necessary before each use. Inspect for leaks, and repair if necessary. **Always use your machine’s manufacturer recommended hydraulic fluid in your machine!** Fluid must be clean and debris free. If damage occurs from debris in hydraulic fluid flowing from your machine to our attachment it will VOID the warranty on any cylinders, motors, couplers, manifolds &/or valves (relief, lock, selector, check and flow control) down line from that flow **5**

SECTION 2

SAFETY INFORMATION

The following terms may be used interchangeably throughout this manual.

Term	Alternate Terms Used
Stump Grinder	implement, attachment, product, grinder, stump remover
Machine	skid steer loader, skid steer tractor, loader, prime mover, host machine, skid steer
Operator	user, personnel

This **Stump Grinder** is designed and manufactured with safety in mind. However, improper use and operator error can result in death or serious injury. It is important that you read and fully understand the safety instructions and operating procedures presented in this manual before operating this attachment. NEVER allow untrained people to operate attachment. Accident prevention is a combination of good judgment, common sense, awareness and proper training!



BEFORE YOU OPERATE THIS STUMP GRINDER:

KNOW how to safely operate your machine.

READ and UNDERSTAND the safety instructions and operating procedures contained in this manual.

ACKNOWLEDGE your understanding of all safety instructions presented in this manual by signing the “Safety Acknowledgment Form” at the end of this manual.

Although every effort has been made to ensure a safe product, every possible circumstance that could pose a potential hazard cannot be anticipated. The warnings presented in this manual and on this product, are therefore not all-inclusive.

In addition to the safety messages presented in this section, you must also read and understand the safety messages presented in the other sections of this manual.

This manual and the decals on this attachment use safety symbols, hazard labels, pictograms and color coded signal words to alert you to potential hazards that may cause severe injury or death if a safety instruction is ignored.



SAFETY ALERT SYMBOL - This symbol is used to alert you to potential personal injury hazards. Obey all safety messages that follow this symbol to avoid possible injury or death.

HAZARD CLASSIFICATIONS

Hazards are identified by the “Safety Alert Symbol” and followed by the signal word “DANGER”, “WARNING”, or “CAUTION”.

DANGER

Indicates an imminently hazardous situation which, if not avoided, will result in death or serious injury.
This signal word is limited to the most extreme situations.

WARNING

Indicates a potentially hazardous situation which, if not avoided, could result in death or serious injury.

CAUTION

Indicates a potentially hazardous situation which, if not avoided, may result in minor or moderate injury.

NOTICE







Indicates a situation which may cause damage to equipment or property.
Messages are not related to personal injury.

Safety Instructions

Indicates specific safety-related instructions or procedures.

2.2 SAFETY SYMBOLS

Pictograms are graphic symbols meant to alert you of a potential hazard. Read and understand the hazard description for each of these symbols.

Pictogram	Description
	<p>PINCH HAZARD: Keep clear of machine and attachment to prevent death or serious injury from pinching of moving parts.</p>
	<p>FLYING DEBRIS HAZARD: ONLY operate this attachment using a machine that has a shatter proof cab to prevent death or serious injury from objects being thrown.</p>
	<p>OPERATING MANUAL: Operators must read and understand the safety instructions in the operating manual to prevent death or serious injury.</p>
	<p>EYE PROTECTION & CARDBOARD: Operators and Maintenance personnel must wear proper eye protection and use cardboard or wood to investigate hydraulic leaks to prevent death or serious injury from being injected with high pressure hydraulic fluid.</p>
	<p>HIGH PRESSURE FLUID INJECTION HAZARD: Operators and Maintenance personnel must not place fingers or hands directly over a hydraulic leak to prevent death or serious injury from being injected with high pressure hydraulic fluid.</p>
	<p>NO BYSTANDERS: DO NOT operate this attachment near bystanders. Bystanders must stay back at least 300 feet from the attachment to prevent death or injury from objects being thrown.</p>
	<p>CRUSH HAZARD: DO NOT place any part of the body under the attachment or machine to prevent death or serious injury from being crushed .</p>

2.3 SAFETY DECAL LOCATIONS

Safety warning decals are located on this attachment near immediate areas of potential hazards. Operators must learn the meaning of each decal and know where to find the decal on the attachment.



2.3 SAFETY DECAL CHART

The safety decals affixed to this machine are to keep you safe. DO NOT ignore these decals.

Read and understand each decal's safety message. Follow these Safety Decal Instructions:

REF	DESCRIPTION	LABEL	QTY
1	DANGER / WARNING COMBO LABEL (CID-85)		1
2	WARNING DO NOT EXCEED GPM LABEL (CID-37, 63, 43)		1

**WHEN ORDERING, CHOOSE THE PROPER DECAL FOR YOUR MODEL*

CONTACT YOUR LOCAL DEALER TO ORDER REPLACEMENT DECALS

! Decals must be kept clean and legible at all times.

! Operators must inspect the attachment for safety decals.

! Replace missing, worn or damaged decals immediately.

! When using a hot pressure washer

to clean this attachment make sure water jet is not too close to the decal as this may cause the decal to peel.

! When replacing parts, be sure safety decals are in place prior to using the attachment.

! Make sure metal surface is dry and free of dirt and grease before affixing decals to this attachment.

2.4 SKID STEER LOADER REQUIREMENTS

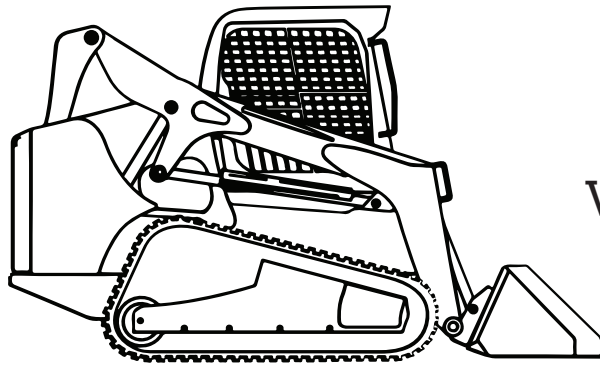

Tracked

VS.



Wheeled

A Tracked Skid Steer or Compact Track Loader (CTL) will provide superior stability in this application.

! CAUTION

Make sure your machine is in good operating condition. Follow the operating instructions found in the operator's manual. Failure to do so could result in minor or serious injury.

Machines MUST HAVE impact resistant windshields, cab side windows and doors.

Consult the host machine's rated operating capacity to ensure you have the proper lift capacity for optimal operation of your attachment.

Flow range MUST support the attachment.

2.5 PERSONAL PROTECTIVE EQUIPMENT (PPE)

All operators should wear hearing protection, safety glasses, hand protection and dust mask while operating this attachment.



2.6 GENERAL SAFETY INSTRUCTIONS



MAKE SURE YOU FOLLOW THE GENERAL SAFETY INSTRUCTIONS THAT RELATE TO THE OVERALL OPERATION AND MAINTENANCE OF THIS ATTACHMENT. IT IS IMPORTANT THAT YOU READ AND UNDERSTAND EACH OF THESE MESSAGES TO PREVENT SERIOUS INJURY OR DEATH.

- ⚠ **NEVER** use drugs or alcoholic beverages while operating or servicing this attachment.
- ⚠ **DO NOT** allow children to play on or around this attachment at any time. Store this attachment in an area not frequented by children.
- ⚠ **ALWAYS** operate this attachment during daylight or well-lit areas.
- ⚠ **ALWAYS** wear the proper personal protection equipment while operating or servicing this attachment. **NEVER** operate or service this attachment with bare feet, sandals, or other light footwear.
- ⚠ We recommend using a high strength clear protective door panel when using with this attachment.
- ⚠ **ALWAYS** wear work gloves when handling this attachment to protect your hands.
- ⚠ To prevent the machine and attachment from rolling forward, stop the engine and set the parking brake when exiting the machine.
- ⚠ **ALWAYS** use eye protection while operating or servicing this attachment.
- ⚠ Inspect attachment for loose or missing hardware prior to using this machine.
- ⚠ **ALWAYS** use eye protection while operating or servicing this attachment.
- ⚠ **ALWAYS** watch for overhead power lines.
- ⚠ **DO NOT** operate this attachment during lightning or severe weather conditions.
- ⚠ **DO NOT** place any part of your body under this attachment.
- ⚠ **DO NOT** allow riders on the machine or on this attachment.
- ⚠ **NEVER** operate this attachment when bystanders are within 300 feet of your work area. Flying debris could cause serious injury or death.
- ⚠ **ALWAYS** call 811, the “Digger’s Hotline” before digging to identify underground utilities to avoid an accident that could result in Death or Serious Injury to the operator.
- ⚠ **NEVER** position your body or limbs under an unsupported attachment.
- ⚠ **DO NOT** speed! Speed Kills! Keep your driving speed between 2 and 5 mph.
- ⚠ **DO NOT** allow this attachment to contact buildings, utilities, or large rocks or you may lose control of the machine.
- ⚠ **NEVER** leave equipment unattended with the engine running, or with this attachment in a raised position.

2.7 FEDERAL LAWS & REGULATIONS

IMPORTANT FEDERAL LAWS AND REGULATIONS CONCERNING EMPLOYERS, EMPLOYEES, AND OPERATORS

This section is intended to explain in broad terms the concept and effect of the following federal laws and regulations. It is not intended as a legal interpretation of the laws and should not be considered as such.

U.S. PUBLIC LAW 91-596 (The Williams-Steiger Occupational Safety and Health Act of 1970) OSHA

This Act Seeks:

“ ... to assure so far as possible every working man and woman in the nation safe and healthful working conditions and to preserve our human resources...”

Sec. 5(a) Each Employer – DUTIES

(1) shall furnish to each of its employees employment and a place of employment which are free from recognized hazards that are causing or are likely to cause death or serious physical harm to its employees.

(2) shall comply with occupational safety and health standards promulgated under this Act.

(b) Each employee shall comply with occupational safety and health standards and all rules, regulations, and orders issued pursuant to this Act which are applicable to his or her own actions and conduct.

OSHA Regulations

Current OSHA regulations state in part: “At the time of initial assignment and at least annually thereafter, the employer shall instruct every employee in the safe operation and servicing of all equipment with which the employee is, or will be involved.” These will include (but are not limited to) instructions to:

Keep all guards in place when the machine is in operation;

Permit no riders on equipment;

Stop engine, disconnect the power source, and wait for all machine movement to stop before servicing, adjusting, cleaning, or unclogging the equipment, except where the machine must be running to be properly serviced or maintained, in which case the employer shall instruct employees as to all steps and procedures which are necessary to safely service or maintain equipment.

Make sure no one is within 300 feet of machinery before starting the engine, engaging power, or operating the machine.

EMPLOYEE MACHINE OPERATING INSTRUCTIONS:

1. Securely fasten your seat belt if the machine has a safety operating system.
2. Where possible, avoid operating the machine near ditches, embankments, and holes.
3. Reduce speed when turning, crossing slopes, and on rough, slick, or muddy surfaces.
4. Stay off slopes too steep for safe operation.
5. Watch where you are going, especially at row ends, on roads, and around trees.
6. Do not permit others to ride.
7. Operate the machine smoothly - no jerky turns, starts, or stops.
8. Hitch only to the drawbar and hitch points recommended by machine manufacturers.
9. When machine is stopped, set brakes securely and use park lock if available.

Child Labor Under 16 Years Old

Some regulations specify that no one under the age of 16 may operate power machinery. It is your responsibility to know what these regulations are in your own area or situation. (Refer to U.S. Dept. of Labor, Employment Standard Administration, Wage & Home Division, Child Labor Bulletin # 102).

SECTION 3

OPERATING PROCEDURES

Your attachment arrives from the factory strapped to a wood pallet and requires no final assembly.

Use a steel band cutting tool to remove the steel straps.

CAUTION

Shipping straps are under great tension, and could lash out uncontrollably when cut causing injuries to your body or bystanders. Keep bystanders away and wear safety glasses and gloves while removing the steel straps.

3.1 PRE-OPERATING CHECKLIST

Pre-Operating Checklist	
<input type="checkbox"/>	Stump Grinder is securely attached to the machine and pins locked.
<input type="checkbox"/>	Hydraulic hoses are connected and locked to the host machine's hydraulic couplers with no signs of hydraulic fluid leaks present.
<input type="checkbox"/>	Stump Grinder is in working condition and securely attached to the machine and all bolts and nuts are tight.
<input type="checkbox"/>	Safety labels are present and legible.
<input type="checkbox"/>	No material, rope, wire, etc. is obstructing the machine or grinder.
<input type="checkbox"/>	The area of operation is clear of bystanders and any obstacles that could damage the equipment or injury to the operator.
<input type="checkbox"/>	The operator is of good health and not under the influence of any mind altering substances or alcohol.
<input type="checkbox"/>	Check the machine's hydraulic fluid level and add manufacturer recommended fluid if necessary. <i>Please refer to our "Hydraulic Fluid and Oil Statement" on Page 5 for gear oil or hydraulic fluid instructions.</i>

3.2 HOW TO CONNECT STUMP GRINDER ATTACHMENT GENERAL ATTACHMENT METHOD

Refer to your machine's manual for specific instructions on how to connect and disconnect your attachment. See figure 4.2c.

This attachment method refers specifically to skid steers. For all other attachment instructions, refer to the Original Equipment Manufacturer (OEM) for instructions.

1. Make sure the hydraulic lines are clear from the front side of the grinder's attachment plate and that the locking pins on the skid steer quick attach mechanism are in the unlocked position.
2. Drive the skid steer to the attachment plate and tilt the skid steer coupler forward and hook the top edge of the skid steer quick attach mechanism under the lip of the grinder's attachment plate. See figure 3.2a below.
3. Slowly raise and tilt back the skid steer mounting plate, moving upward until the grinder's attachment plate is flat against the skid steer quick attach mechanism. See figure 3.2a below.

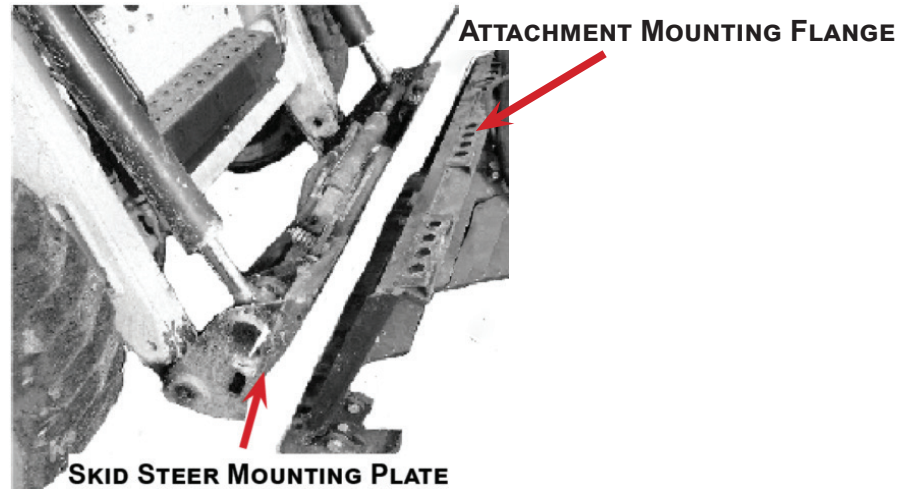
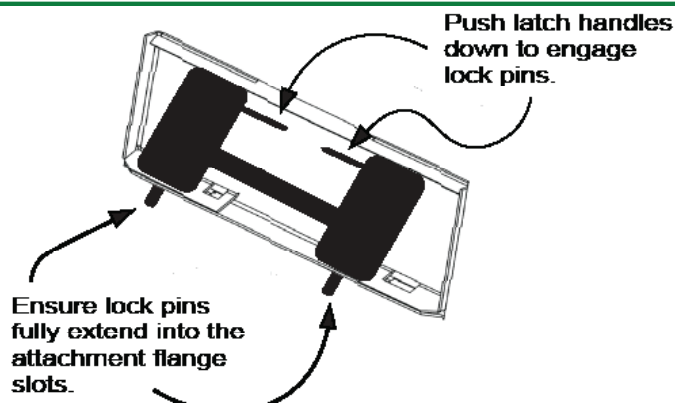

FIGURE 3.2A - SKID STEER MOUNTING PLATE TO ATTACHMENT MOUNTING FLANGE

4. Activate your skid steer's lever lock switch to engage and lock the pins into the flange slots of the grinder's attachment plate. If your skid steer does not have this switch, push the latch handles down until you can see the lock pins extend into the attachment flange as shown in Figure 3.2b below.



**FIGURE 3.2B QUICK ATTACH COUPLER
LOCKED TO ATTACHMENT PLATE**



**FIGURE 3.2C TRACTOR PIN ON
HOOKUP**

3.2 HOW TO CONNECT STUMP GRINDER ATTACHMENT CONT.

! WARNING To avoid serious injury or death, ensure coupler pins fully extend through the slots on the attachment bracket and that levers are down in the locked position to prevent attachment from detaching from machine.

NOTICE To keep contaminants from entering the hydraulic system, use a clean cloth to wipe away dirt and grease from the hydraulic couplers and cover with plastic or metal caps when not in use.

5. Connect the attachment hydraulic hoses to the auxiliary supply couplers located on your skid steer loader lift arm.

NOTICE Check that hydraulic hoses are locked into the machine's couplers before moving the grinder.

Check the hose routing through the full range of intended motion before operating attachment. It is the responsibility of the owner/operator to make sure the hoses are routed correctly and are not pinched.

! CAUTION
ALWAYS visually inspect and verify that the coupler lock pins are fully engaged through the latch slots on the attachment plate.

! DANGER
NEVER enter the area underneath the coupler or any part of the attachment when it is in the raised position to avoid an accident that will result in Death or Serious Injury!

3.3 STUMP GRINDER CONTROLS

STUMP GRINDER CONTROLS

Your stump grinder is designed to run off the machine's auxiliary hydraulic system, and is activated and deactivated by a control in the operator's cab. The height and tilt functions of your stump grinder are operated with the control handles or pedals in the cab. Consult your machine operator's manual for instructions regarding these functions.



3.4 HOW TO DISCONNECT STUMP GRINDER

1. Park machine on a flat and level surface then lower stump grinder to the ground.
2. Wait for blade and motor to idle down completely and stop before exiting the operator's cab.
3. Turn off auxiliary hydraulic circuit; relieve hydraulic pressure by moving the joysticks back and forth or pressing the hydraulic relief valve (if applicable).
4. Set parking brake and disengage lock pins using the lock lever switch (if installed).
5. Turn off machine engine.
6. Disconnect hydraulic hoses and connect together or install dust caps to prevent contaminants from entering the hydraulic system.
7. Pull latch handles to disengage lock pins.
8. Re-enter cab and start machine engine.
9. Tilt mounting coupler forward until Quick Attach Coupler is free from mounting bracket.
10. Drive machine backward to clear cutter.

3.5 HYDRAULIC SYSTEM



Please refer to our “Hydraulic Fluid and Oil Statement” on Page 5 for gear oil or hydraulic fluid instructions.



HYDRAULIC FLOW

When operating the Stump Grinder, set the machine engine RPM to a speed that will produce the required flow. Your machine dealer can measure the flow available on your machine and recommend a throttle setting that is compatible with this attachment.

DO NOT EXCEED the designated flow rate (GPM).

NOTICE

If the hydraulic function operates in the opposite direction than preferred, change the positions of the quick disconnect couplers on the attachment hoses to remedy the problem.

NOTICE

ALWAYS release the hydraulic system pressure from the hydraulic circuits prior to removing the attachment or any hydraulic service work.

WARNING

Make sure the case drain hose is properly attached to the host machine's case drain connection.

Warranty WILL BE void if attachment is ran without the case drain hose connected. Excessive hydraulic pressure can blow out seals and damage the motor.

3.5 HYDRAULIC SYSTEM CONT.

CAUTION It is extremely crucial to protect your hydraulic hoses from damage or destruction as hydraulic failure could result in damage to your attachment or machine and death or serious injury.

1. Make sure your hydraulic hoses are appropriately restrained in the D-Rings and hooks provided to prevent accidentally cutting them with the blade.

2. STEP 1: Beginning from the motor, feed the hydraulic lines through the D Ring located in the middle of the attachment frame.

3. STEP 2: Wrap the hydraulic line back through the D-Ring on either the Left or Right side of the attachment depending which side your coupler is located. *See Step 2 Example*

4. STEP 3: Since the majority of hydraulic couplers are located on the Left side, there is also a Crop D-Ring on the Left side as a final safety precaution. *See Step 3 Example*

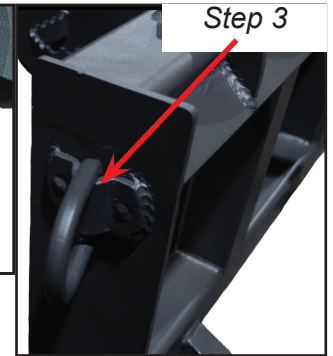
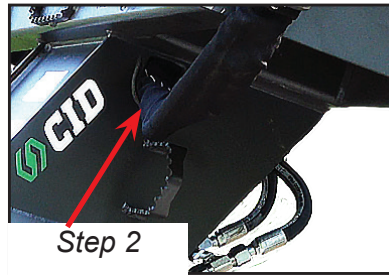

5. It may require adjusting the hoses to get them through the D-Ring. (For 3/4 you will have to **remove the couplers**, and check fluid.)

DANGER *MAKE SURE to depressurize the hydraulic hoses before removing the couplers.*

3.6 DIGGING PREPARATION

DANGER

ALWAYS contact 811, the “Digger’s Hotline” to identify underground utilities to avoid an accident that could result in Death or Serious Injury!

ALWAYS be aware of your surroundings and pay attention to obstacles and terrain around you.



**Know what's below.
Call before you dig.**

You must notify utility companies of your intent to dig or trench by calling 811 or making an online request with your state’s 811 center a few days prior to digging or trenching. Visit: <https://call811.com/811-In-Your-State> to connect to your state’s 811 center.

3.7 PREPPING FOR FIRST TIME USE

Verify that hydraulic hoses are securely locked to the machine hydraulic couplers before starting to use this attachment.

NOTICE

Before operating the attachment, check the hydraulic fluid in the machine and add fluid if necessary.

Please refer to our “Hydraulic Fluid and Oil Statement” on Page 5 for gear oil or hydraulic fluid instructions.

1. After starting machine, lift attachment eighteen (18) inches off the ground surface:
2. Set machine engine RPM to just above idle.
3. Slowly engage the auxiliary hydraulic flow to the attachment until the function operates.
4. Let the attachment run for 5 minutes.
5. Disengage hydraulic drive and wait for all motion to stop before lowering the attachment to the ground.
6. Shut off machine engine and exit the operator’s cab.
7. Check the hydraulic fluid level in the machine, add manufacturer recommended fluid if necessary.
8. Inspect the hydraulic lines & connectors for noticeable leaks. Fix before continuing

DANGER

To avoid serious injury by hydraulic fluid injection into your skin, never use your hand or other body parts to locate a hydraulic leak. Detect leaks with a piece of wood or cardboard. In the event of fluid injection in the skin, see a doctor IMMEDIATELY as the fluid must be surgically removed right away or gangrene may result.

3.8 LEARNING YOUR ATTACHMENT

DANGER

NEVER operate the attachment when bystanders are within 300 feet of your work area.

CAUTION

USE CAUTION when operating on un-level ground surfaces. A machine roll over could result in Minor or Serious Injury. ALWAYS wear your seat belt when operating this attachment.

3.8 LEARNING YOUR ATTACHMENT CONT.

1. Before using this attachment, make sure you are knowledgeable and comfortable with the operation of the auxiliary hydraulic control as outlined in previous sections of this manual and in the machine's operator's manual.
2. When operating this attachment, set the machine throttle at a speed that will produce the required flow. If the machine is equipped with a foot throttle, use it to control engine speed and power being delivered to the attachment. Refer to your machine manual or call your local machine dealer for additional help if necessary.
3. Learn what the attachment looks like in a level position when you are seated in the machine. This will help you when operating the attachment.
4. The correct ground speed while using this attachment depends on the application and condition and can usually be monitored by sound and feel and depends on the material density.
5. Note that if the machine engine is bogging down because of the effort to cut with the attachment, it will be necessary to decrease the cut size until the machine's power can overcome the material load on the attachment.

3.9 BEFORE STARTING

! DANGER

ALWAYS contact 811, the "Digger's Hotline" to identify underground utilities to avoid an accident that could result in Death or Serious Injury!

! WARNING

EXPOSURE to crystalline silica dust along with other hazardous dusts may cause serious or fatal respiratory disease. It is recommended to use dust suppression, dust collection and if necessary personal protective equipment during the operation of any attachment that may cause a high level of dust.

1. Inspect the area to be worked and make sure it is free of any buried utilities, rocks, fence posts, or any other hazards or objects that you do not want to move.
2. Observe overhead electrical and other utility lines. Be sure equipment will clear them.
3. Determine a safe and efficient pattern before the start of the job.



3.10 DETERMINING THE PROPER GRINDING PROCESS

1. Each stump requires a complete evaluation.
2. Measure the footprint of the tree including the height of the stump and the base root ball to give an estimation of how many passes will be needed as well as how long it will take.
3. Determine the type of wood being cut; soft, hard, old, or knotty, as each type requires a slightly different process. **See Section 3.13**
4. For most woods, the chips from grinding wood stumps, should look like banana peels and wood chips. **See Example 1**
6. If the wood chips are like fine dust, you are either grinding a hard wood or the teeth are dull and may need rotated or replaced.
7. MEDIUM WOOD: As the wood progresses in hardness, the size of “banana peels” may decrease some but should still look similar.
8. VERY OLD OR HARD WOOD: These trees may require smaller “bites”, slower cutting and may create more of a fine dust than banana peels. **See Examples 2 & 3**



Example 1

5. SOFT WOOD: The stump grinder should easily grind 1-2 inches passes of wood at a time without difficulty. When not sure if grinding correctly, review the photo above to see what the wood chips should look like.

NOTICE

If beginning to grind and the stump grinder jerks, too big of a bite of wood is being taken. Decrease the size of the bite, and try again. When first starting, move slower as it may take time to operate this attachment effectively.



Example 2



Example 3

CAUTION

Use caution when cutting old, hard wood as it may cause the stump grinder to smoke. Take frequent breaks to allow the metal to cool off before proceeding.

3.11 DETERMINING THE HARDNESS OF THE WOOD

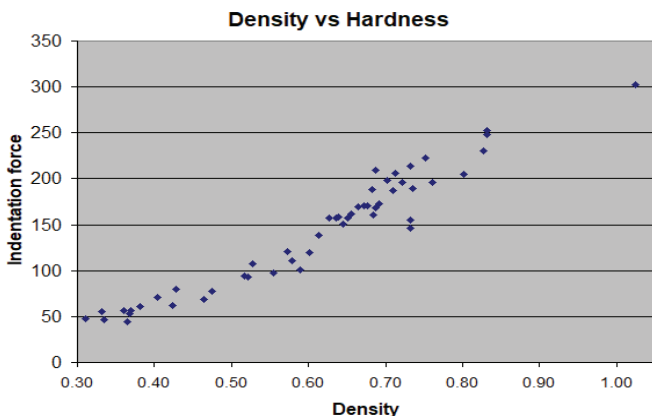

When preparing for stump grinding, it may be difficult to ascertain the hardness of the wood. Old and dried out wood may be even more difficult to judge. The Janka Hardness and Density Rating may be a helpful tool to guide you on the hardness and wood density, which will guide the process for removal. **SEE THE**

FOLLOWING PAGE FOR CHARTS TO HELP YOU DECIDE.21

3.11 DETERMINING THE HARDNESS OF THE WOOD CONT.

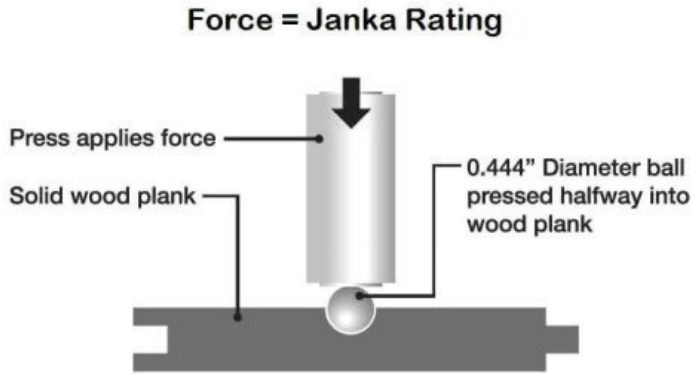

Species	Pressure to Mar (In Pounds)
Hickory, Pecan	1,820
Hard Maple	1,450
White Oak	1,360
Beech	1,300
Red Oak	1,290
Yellow Birch	1,260
Green Ash	1,200
Black Walnut	1,010
Soft Maple	950
Cherry	950
Hackberry	880
Gum	850
Elm	830
Sycamore	770
Alder	590
Yellow Poplar	540
Cottonwood	430
Basswood	410
Aspen	350

3.12 NAVIGATING WITH THE STUMP GRINDER

When navigating with the stump grinder attached, it is important to raise the attachment at least 12-18 inches off the ground to prevent catching the motor protection frame and damaging it. **Remember: Removal of the motor protection frame voids the warranty!**



3.13 GRINDING INSTRUCTIONS

1. With the operator in the seat of the loader and the seat belt fastened, start the engine.
2. For optimal operation of the attachment, try to approach the stump from a position that will allow the machine to sit as level as possible with the stump.
3. Position the loader so the attachment is on the right side of the stump. Use the machine's tilt function to lift the attachment slightly above and to the right of the stump. *See Example 1*

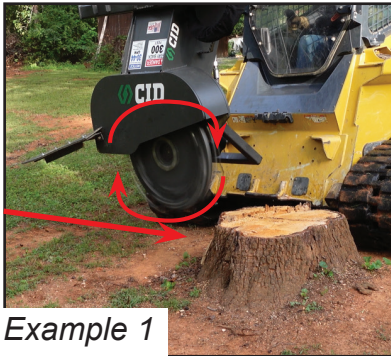

4. Engage the hydraulics on the loader, increase the throttle to maximum speed, and using the controls, lower the cutting wheel on the far side of the stump.
5. Once the attachment has started grinding, engage the track/wheels and move in a forward and reverse pattern.
6. Only cut into the stump at a depth of 1 to 2 inches per pass. *See Example 2*

NOTICE
Rate of cut will be determined by the condition of the teeth, type of tree, and condition of the stump. *See Next Page*

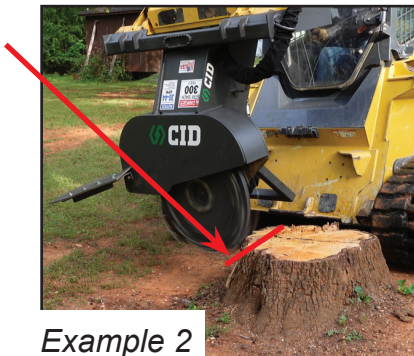

7. When the attachment has completed a pass, move the machine towards the stump 1-2" and continue grinding.
8. Continue until a completed layer of stump has been ground off and then repeat the procedure starting again at the front of the stump. *See Example 3*



9. The next cuts will be performed to take the stump below ground level if wanted. *See Example 4*



10. Follow the same procedures as cutting above ground level, with the exception of 1) inspecting the area thoroughly for large rocks/debris that may damage the attachment and 2) monitor your cut depth so as to not damage your chip guard.

NOTICE Please note that when removing a stump at the top of an incline, the grinder will not be able to grind as deeply as when the machine is on a level surface due to the motor protection frame. It is always recommended to have the machine on the same flat surface as the tree stump that is being removed.

! WARNING NEVER remove the motor protection frame as it will leave your motor unprotected and vulnerable to damage and WILL IMMEDIATELY VOID YOUR WARRANTY!

3.13 GRINDING INSTRUCTIONS CONT.

11. Continue to grind the stump until the desired depth has been achieved.

12. We recommend backfilling holes with dirt instead of chips so as to prevent settling and decrease risk of injury.

WARNING

To avoid injury or death, watch out for flying rocks and/or debris when cutting below ground level.

3.14 OPERATING GUIDELINES

DANGER

To prevent death from electrocution, NEVER operate this attachment near electrical wires or cables.

NOTICE

Harder woods will require smaller cuts, but softer woods can be removed with larger cuts.

1. ALWAYS inspect the work area before starting the job. Locate and mark any utilities (also turn utilities off), steel posts, rocks or any other objects that could be damaged or could damage this attachment during operation.
2. NEVER assume the work area is safe and skip the inspection before start of operation.
3. Operate at a safe slow-paced speed that will allow you to watch the area ahead and behind the attachment and machine.
4. **Look behind you** and/or utilize your mirrors and back-up camera when backing up.
5. VERIFY that your back-up alarm and camera are working properly to warn others when you are in reverse, but NEVER think that the alarm or camera replaces your responsibility to visually check what is behind you.
6. Attachment control is the most important element to getting a good steady work flow.
7. Before beginning your forward motion with your attachment, stop the machine and make any final adjustments to the attachment for weight and height.
8. When using your hydraulic attachment, make sure that you can visually see the stump. Beware of pushing or pulling down trees or any type of structure in which you cannot visually see the process.
9. When you begin using the stump grinder, start grinding on the chip guard side and move in the opposite direction.
10. To finish cutting the stump, move forward to reverse.
11. To save service work and down time, always pay attention that tree branches or roots do not poke through past the attachment arms and damage any hydraulic parts or even enter the cab area.
12. Be careful that a branch or root does not “whip” back at the machine. Wear safety glasses to prevent dirt getting in your eyes. The manufacturer highly recommends a closed in cab with the door shut.
13. Keep your distance from any type of utility, whether underground or in the air.



SECTION 4

MAINTENANCE PROCEDURES

The maintenance procedures described in this manual should only be carried out by qualified mechanics who have been trained to repair this attachment.

Some procedures require special tools and skills to complete. **DO NOT** attempt to repair or perform service work on this attachment unless you have the skills and tools to do so. Contact your local dealer for maintenance and repair services.

WARNING

PARTS







Only use genuine **MANUFACTURER** replacement parts on this attachment. We will not be liable for any damages or injuries caused by the use of after market parts on this attachment.

NOTICE

Improper maintenance or modifications to the design or performance of this attachment will void the warranty. **ONLY** use genuine replacement parts on this attachment.

Safety Instructions

Obey the following safety instructions when servicing or repairing this attachment.

-  Wear proper Personal Protective Equipment (PPE) while working on this attachment, which may include safety glasses, hard hats, steel toe boots, gloves, etc.
-  Only perform service work in a well-lit area.
-  If servicing is performed while the attachment is attached to the machine, turn engine off, set parking brake and chock wheels to prevent machine from moving.
-  Allow the attachment to cool down before servicing this attachment. Hot oils can burn your skin.
-  Ensure all jack stands, lifts and hoists are in good working condition and have the rated load capacity to support the load.
-  **NEVER** work under an unsupported attachment.

WELDING REPAIRS

Welding on attachments must be performed by certified welders who have requested and obtained written approval from an authorized representative of the manufacturer before welding begins.

All authorized welding repairs must be performed by qualified welders in accordance to the American Welding Society (AWS) standards. Welding procedures performed by unqualified welders may deem this attachment unsafe to operate and **VOID THE WARRANTY!**

4.1 MAINTENANCE SCHEDULE.

This Stump Grinder attachment will provide years of dependable service if routine maintenance procedures are performed. The maintenance tasks listed below are based on normal operating conditions and **should never be performed while the attachment is in operation**. More frequent maintenance may be necessary with intense use or when operating in adverse

MAINTENANCE TASK	BEFORE EACH	WEEKLY	YEARLY
	USE		
<p>Check host machine's hydraulic fluid level. Add manufacturer recommended fluid as necessary.</p> <p><i>Please refer to our "Hydraulic Fluid and Oil Statement" on Page 5 for gear oil or hydraulic fluid instructions.</i></p>	X		
<p>Check that all fasteners (nuts, bolts, washers, pins, keepers) are in place. Tighten as necessary.</p>	X		
<p>Inspect and replace any worn, torn, or missing safety decals.</p>	X		
<p>Inspect hydraulic hoses and connectors for damage or leakage. Repair or replace hydraulic items as necessary.</p>	X		
<p>Check oil level in bearing house. Add oil as necessary.</p>		X	
<p>Change 85-140 oil in bearing house. *Change oil after 50 hours of first time use, then every 1000 hours or yearly.</p>			X 1,000 HRS
<p>Wash stump grinder.</p>		X	
<p>Check stump grinder for major scratches & dings. Sand and repaint these areas to prevent rust damage.</p> <p>*Contact the manufacturer for approved OEM paint for your attachment.</p>			X

DANGER

ONLY service the stump grinder on stable, even terrain. NEVER park on sloped terrain to avoid being struck and killed or seriously injured by the unexpected rolling or movement of the attachment or machine.

4.1 MAINTENANCE SCHEDULE CONT.

MAINTENANCE TASK	Daily /	WEEKLY	YEARLY
	Every 10 Hrs	EVERY 50 HRS	EVERY 2,000 HRS
BEFORE STARTING STUMP GRINDER:			
All stump grinder bolts are property torqued and none are missing.	X		
Disc is in good condition. No cracks, gouges, or heat discoloration.	X		
All tooth holders are sitting flat with disc.	X		
All teeth are still in the wear zone and are have not reached the weld line.	X		
START UP:			
All protective devices are in place and secure.	X		
Warning sign "Stay out of Reach" in place & visible.			
No unusual noises or vibrations.	X		
SHUT DOWN:	X		
When stump grinder disc binding or pinching			
When stump grinder disc jammed.	X		
Check Fastener Tightening Torques. <i>Instructions on Pg 31</i>		X	
Disc Complete Inspection			X

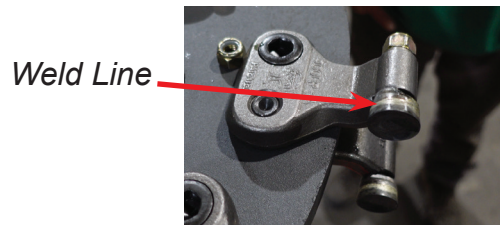
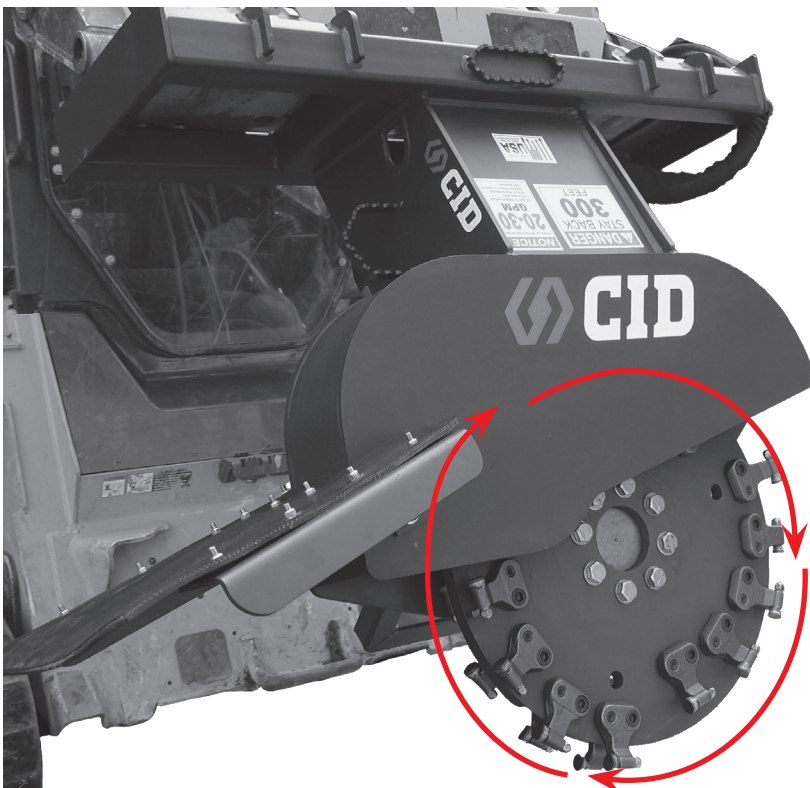

4.2 TORQUE SPECIFICATION TABLE AND INSTRUCTIONS

BOLT TORQUE INSTRUCTIONS

1. Apply and maintain proper torque on all bolts.
2. Torque values are based on lubricated values. **Do not grease or oil bolts.**
3. Wipe bolts clean and use Loctite 635 or equivalent before tightening bolts. May need curing activator.
4. Use a torque wrench to assure the proper amount of torque is being applied to the bolt.
5. **MUST CURE 72 HOURS BEFORE USE TO PREVENT LOOSENING OF BOLTS.**

TORQUE VALUES

SAE GRADE 8

	DRY	LUBRICATED
	lb.-ft.	lb.-ft.
1/4"	12	9
5/16"	24	18
3/8"	45	35
1/2"	110	80
3/4"	380	280
7/8"	600	450
1"	910	680
1 1/4"	1820	1360
1 1/2"	3162	2688

4.3 TORQUE EQUIPMENT REQUIREMENTS

TOOLS & EQUIPMENT REQUIREMENTS

To complete the maintenance procedures described in this section, you may need the following tools:

- 1/2 inch drive breaker bar
- 3/4 inch impact socket
- 1/2 inch impact socket
- Tapping Hammer
- 1/2 inch drive torque wrench
- Nylon pry bar set
- Safety stands
- **Loctite 635 or Equivalent-MUST CURE 72 HRS**
- Lifting device (overhead crane hoist, forklift)



NOTE:

When removing bolts with Loctite, it will be necessary to apply localized heat of at least 250 degrees Celsius or to 482 degrees Fahrenheit to loosen bolts.

LOCTITE 635 TECHNICAL SPECIFICATIONS FOR BONDING, CURING, REMOVAL AND INSTALLATION CAN BE FOUND HERE:
<https://next.henkel-adhesives.com/>

4.4 MAINTENANCE LOG INSTRUCTIONS



MAINTENANCE LOG

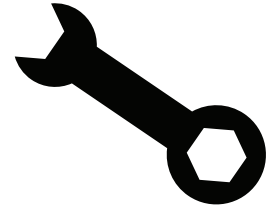

Use the log sheets on at the end of this manual to document all routine maintenance and repair services performed on this attachment.

10. MAINTENANCE

MAINTENANCE LOG

DESCRIPTION OF MAINTENANCE/REPAIR	SERVED BY:	DATE:
<i>Replace Putter Blades</i>	<i>Joe Smith</i>	01/24/24
<i>Inspect Hydraulic Plumbing</i>	<i>Joe Smith</i>	02/25/24
<i>Change Oil in Bearing Housing</i>	<i>Joe Smith</i>	04/24/24

4.5 STORAGE TIPS

	<p>Ensure attachment is free of debris, dirt and grease.</p>
	<p>Store your attachment in a dry shed or garage.</p>
	<p>When storing your attachment for the season, cover with a weather proof tarp to protect it from the elements.</p>

4.6 BLADE SAFETY

! WARNING

1. NEVER weld on a blade.
2. REPLACE the blade if cracks and/or excessive damage are present.
3. The blade MUST be disassembled at every 2,000 service hours (hour meter only) allowing for complete inspection which is impossible on an assembled unit.

4.7 TOOTH HOLDER INSPECTION AND REPLACEMENT

TOOTH HOLDER INSPECTION

1. Place Stump Grinder firmly on the ground with the blade in the horizontal position and lock out in place. *See Example 1*
2. With gloves on, slowly rotate the disc by hand. Thoroughly clean the visible part of BLADE, all TOOTH HOLDERS, and TOOTH.
3. Carefully inspect each Tooth Holder for cracks, damage, or excessive wear, looseness, missing or damaged Tooth Holder or Bolt.
4. All damaged or loose parts MUST BE REPLACED.
5. Replace ALL damaged and/or excessively worn TOOTH HOLDERS and BOLTS. Refer to "Tooth & Tooth Holder Torque Specification Chart on page 31.
6. Refer to the Blade Assembly Diagram on page 40 and Tooth & Tooth Holder Torque Specification Chart on page 31 for tightening torque values and conditions.

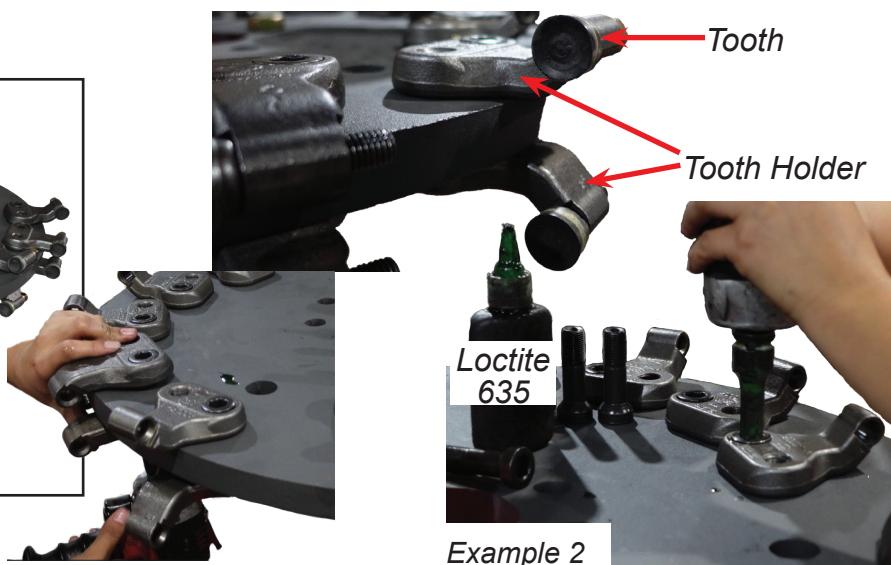
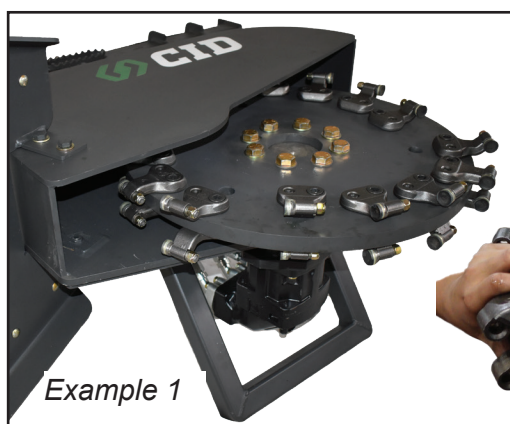

TOOTH HOLDER BOLT REPLACEMENT

1. With the Stump Grinder firmly on the ground with the blade in the horizontal position and lock out in place. *See Example 1*
2. Loosen the (2) bolts that hold each tooth holder in place until tooth holder can be removed.
3. Place the new Tooth Holder on the blade and align with the bolt holes.
4. *NEW POCKET HOLDER BOLTS are required when replacing a Tooth Holder*.
5. Apply Loctite 635 or equivalent on first Pocket Holder Bolt and insert into hole. *See Example 2*
6. Torque to the "Tooth & Tooth Holder Torque Specification Chart" on page 31 for tightening torque values and conditions.
7. Repeat with remaining Pocket Holder Bolt.

4.8 TOOTH AND TOOTH HOLDER TORQUE SPECS

PRODUCT	QUANTITY
900LP-A (ANGLE)	24
900LP-R (REVERSE)	2
900LP-S (STRAIGHT)	4
900-WS2 (TOOTH)	30
LP-212 (POCKET BOLT)	30

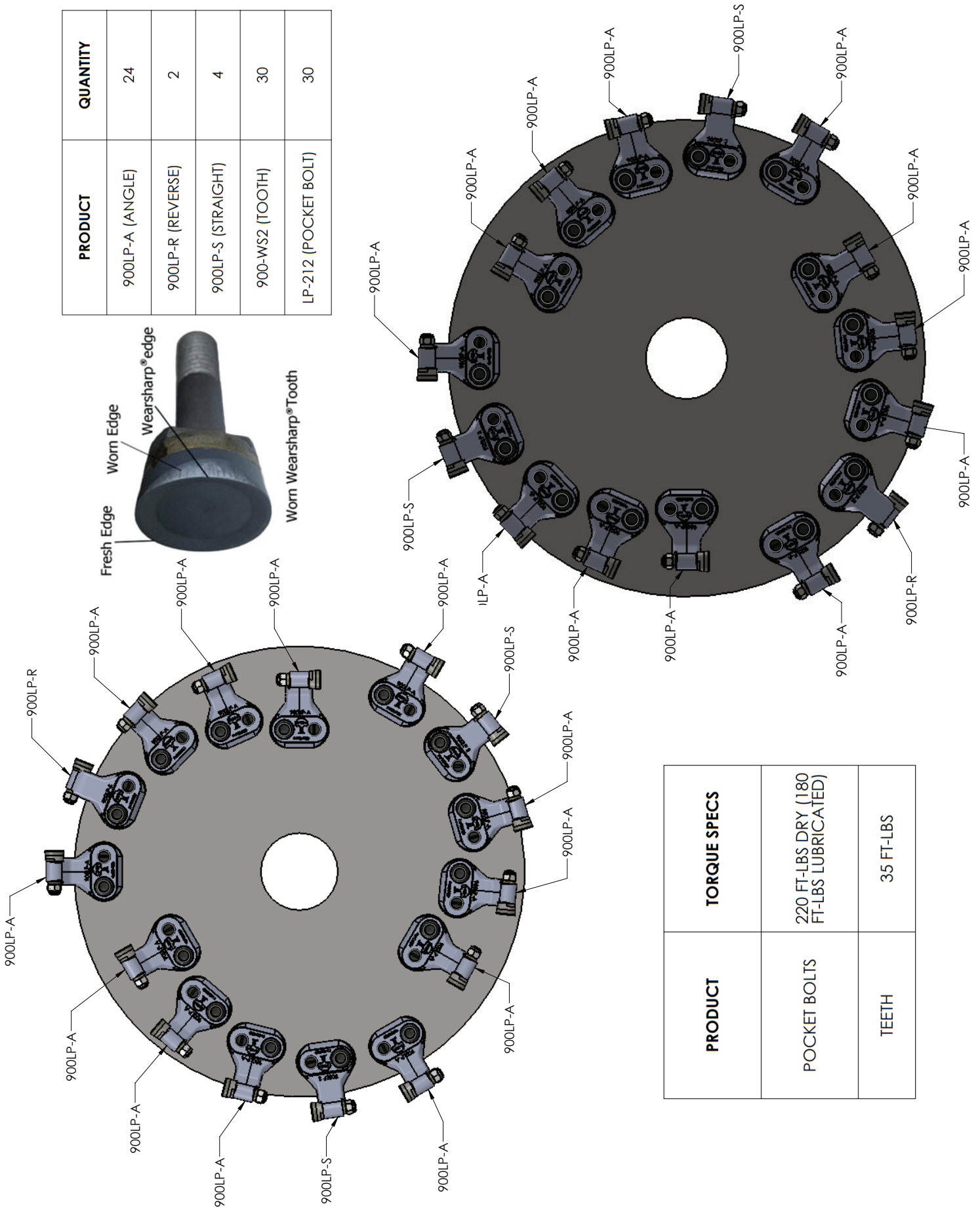
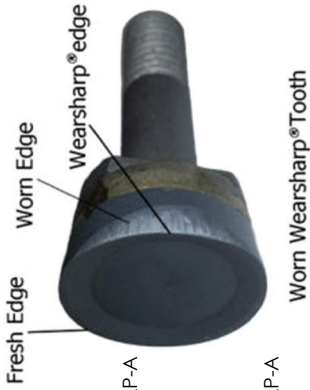

PRODUCT	TORQUE SPECS
POCKET BOLTS	220 FT-LBS DRY (180 FT-LBS LUBRICATED)
TEETH	35 FT-LBS

4.9 TOOTH INSPECTION & REPLACEMENT

1. Place Stump Grinder firmly on the ground with the blade in the horizontal position and lock out in place. *See Example 1*

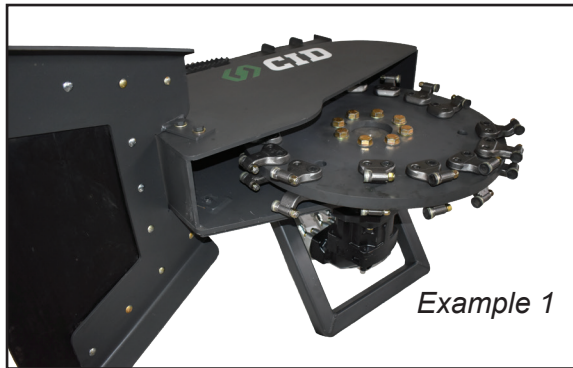

Example 1

2. With gloves, slowly rotate the blade by hand.

3. Thoroughly clean the visible part of BLADE, all TOOTH HOLDERS, and TOOTH.

4. Carefully inspect each TOOTH, TOOTH BOLT, and SPACER for looseness, cracks, damage, or excessive wear.

5. All damaged or loose parts must be replaced. Refer to Tooth & Tooth Holder Torque Specification Chart on page 31 for tightening torque value and tightening condition.

6. Carefully inspect ALL teeth. Each Tooth should have visible wear remaining before the weld line. *See Example 2*

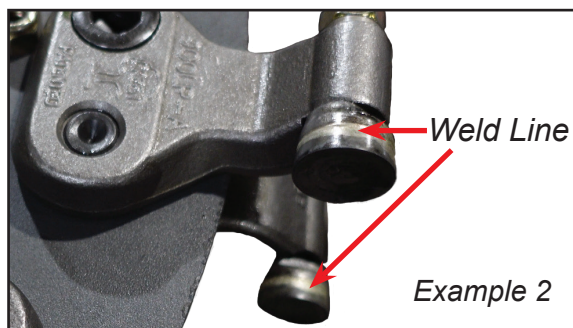

Example 2

7. If there is more wear available on a different section of the tooth, it may be Rotated 180 degrees.

8. To replace Tooth, loosen Tooth Nut and back out. Tap on the head of the Nut, not threads, until Tooth pops loose. (May need heat. Pg 28.)

9. Remove TOOTH BOLT, SPACER, and TOOTH.

10. Ensure that the mating surfaces of the Tooth and Tooth Holder are clean and free of burrs.

11. Insert New Tooth into Tooth Holder. *See Example 3*

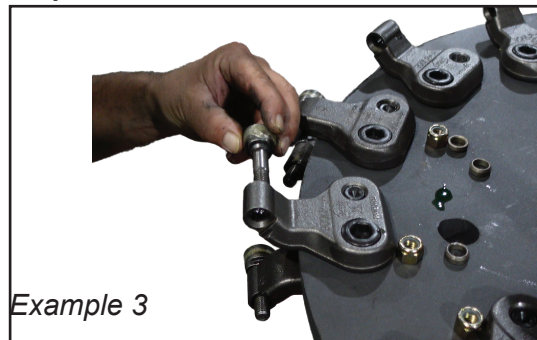

Example 3

12. Install SPACER with the beveled edge pointing towards the Tooth Holder. *See Example 4*

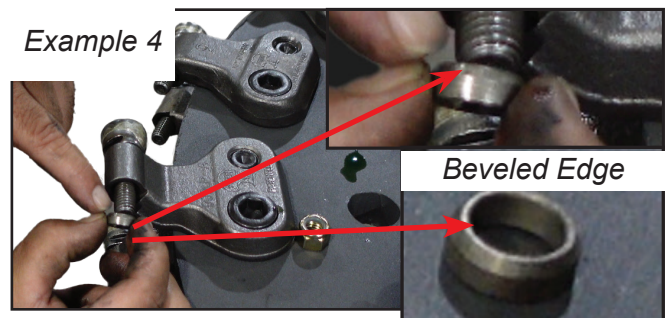

Example 4

13. Apply Loctite 635 or equivalent to the new Tooth threads.

NOTICE Check for tooth assembly clearance. The shoulder of the tooth must fit snugly against the shoulder of the tooth holder.

NOTICE Damaged or excessively worn teeth will reduce blade life and decrease operating efficiency. **ALWAYS** use sharp teeth.

REPLACE TEETH UNDER THE FOLLOWING CONDITIONS:

- Unbalanced blade
- Missing tooth
- Damaged Teeth (fragmented)
- Worn cutting edges.

4.9 TOOTH INSPECTION & REPLACEMENT CONT.

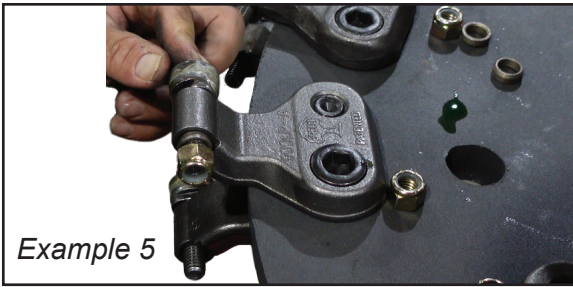

14. Add LOCKNUT and finger tighten. **See Example 5**

15. Torque TOOTH BOLT to specific tightening torque values and tightening condition as specified in "Tooth & Tooth Holder Torque Specs" on page 31. **See Example 6**

16. Repeat this procedure for the opposite tooth

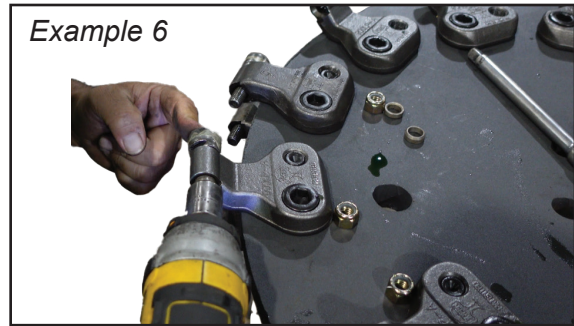

and for all other teeth that have to be replaced.

17. ALWAYS replace two teeth of equal weight and install them 180° opposite each other to prevent the blade unbalancing. **Always use new bolts and spacers, and locknuts.**

NOTICE

Worn teeth can be rotated to extend life. Try to match tooth weight to prevent blade from becoming unbalanced.

SIGNS OF TOOTH WEAR THAT AFFECT QUALITY & PERFORMANCE:

- Grinding speed abnormally slowing down.
- Excessive smoke and heat.
- Cloud of fine sawdust.
- Excessive temperature of teeth.

4.10 HOW TO ROTATE TEETH

1. Place Stump Grinder firmly on the ground with the blade in the horizontal position and lock out in place. **See Example 1**



2. With gloves, slowly rotate the blade by hand until you reach the worn Tooth.

3. Thoroughly clean the visible part of the TOOTH & TOOTH HOLDER.

4. To Loosen Tooth, loosen TOOTH NUT and back out. Tap on the head of the Nut, not threads, until Tooth pops loose. (May need heat. Pg 28.)

5. Rotate the TOOTH 180 degrees. **See Example 2**

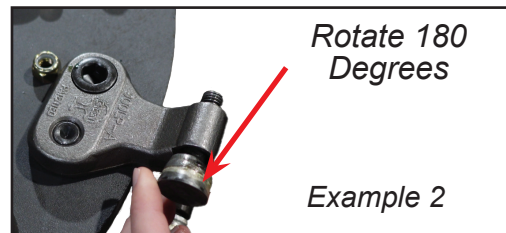

6. Place spacer with beveled edge pointing towards the Tooth Holder. **See Example 4 on page 32.**

7. Apply Loctite 635 or equivalent to the Tooth threads.

8. Add Locknut and finger tighten. **See Example 5 above.**

9. Torque TOOTH BOLT to specific tightening torque values and tightening condition as specified in "Tooth & Tooth Holder Torque Specification Chart" on page 31. **See Example 6 above.**

10. Repeat this procedure for the opposite tooth and for all other teeth that need rotated.

NOTICE

Teeth may be rotated multiple times until the weld line is reached.

4.11 HOW TO REPLACE RUBBER CHIP GUARD

1. Place Stump Grinder firmly on the ground with the blade in the horizontal position and lock out in place. *See Example 1*

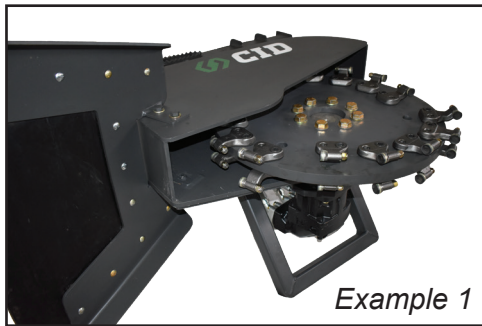

6. Place a flat washer on the bolt on the rubber side. *See Example 4*



2. Carefully remove the eleven (11) bolts holding the rubber flap to the Chip Guard Frame.

3. Thoroughly clean the Chip Guard Frame and bolt holes.

4. Place new rubber flap and align with bolt holes on Chip Guard Frame. *See Example 2*

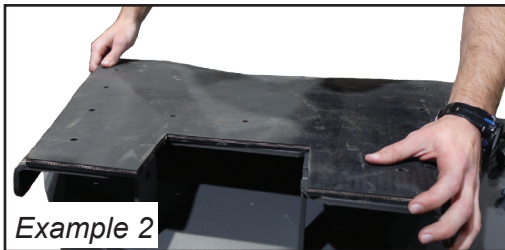

7. Place the nut on the bolt and finger tighten. *See Example 5*



5. Insert Bolts into holes from the bottom up. *See Example 3*



8. Make sure the bolts are seated in the Chip Guard Frame appropriately. Do NOT overtighten to prevent damage to the rubber. *See Example 6*

9. Repeat with remaining bolts.

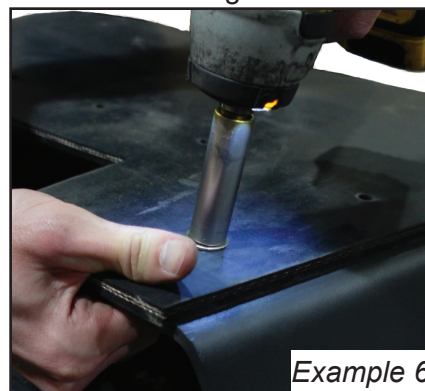

4.11 HOW TO REPLACE CHIP GUARD FRAME

1. Place Stump Grinder firmly on the ground with the blade in the horizontal position and lock out in place. *See Example 1*

2. Carefully remove the two (2) bolts on each side of the Chip Guard Frame.

3. Thoroughly clean the bolt holes.

4. Place new Chip Guard Frame and align with bolt holes on the Frame Weldment.

5. Insert Bolts into holes and finger tighten.

6. Torque to the specifications listed on page 28.

7. Repeat with remaining bolts.

4.12 HOW TO REPLACE THE MOTOR PROTECTOR FRAME

1. Remove the attachment from the host machine as listed in Section 3.5.
2. Raise the attachment 6 inches off the ground by rigging a pair of choker slings around the frame weldment and connecting to an overhead hoist that has the appropriate weight rating.
3. Carefully remove the two (2) hex bolts on each side of the Motor Protector Frame and remove frame. **See Example 1**
6. Place a flat washer on the hex bolt and insert into Frame Weldment.
7. Apply a second flat washer on the other end of the bolt and finger tighten the Locknut. **See Example 2**

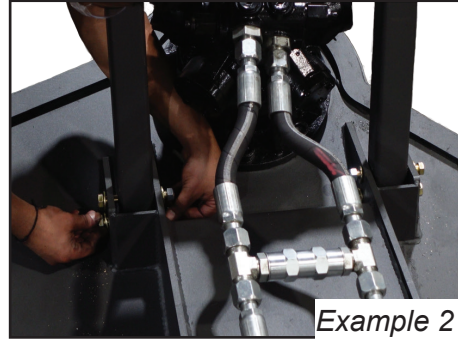

4. Thoroughly clean the bolt holes.
5. Place new Motor Protector Frame and align with bolt holes on the Frame Weldment.

8. Repeat for remaining bolts and finger tighten. **See Example 3**
9. Torque to the specifications listed on page 28.

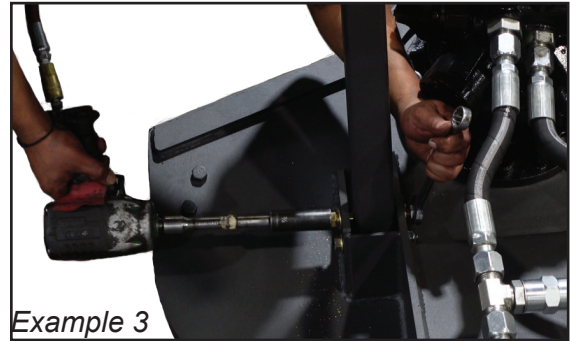

! DANGER

To prevent a crushing death by the attachment, the slings and hoist must be held in a secure and unmoving position. NEVER stand underneath an attachment!

4.13 GEARBOX & DRIVE BEARING HOUSING MAINTENANCE



Please refer to our “Hydraulic Fluid and Oil Statement” on Page 5 for gear oil or hydraulic fluid instructions.



NOTICE

Maintenance procedures for the drive bearing housing require special tools and skills. DO NOT attempt to service drive bearings or gear boxes unless you have the tools and skills to do so.

CHECKING OIL LEVEL

1. Check the oil level weekly. Refill with 85-140 grade gear oil.
2. Check the oil level by removing the oil filler plug. The oil level should be to the bottom of the oil filler plug

4.13 GEARBOX & DRIVE BEARING HOUSING MAINTENANCE CONT.

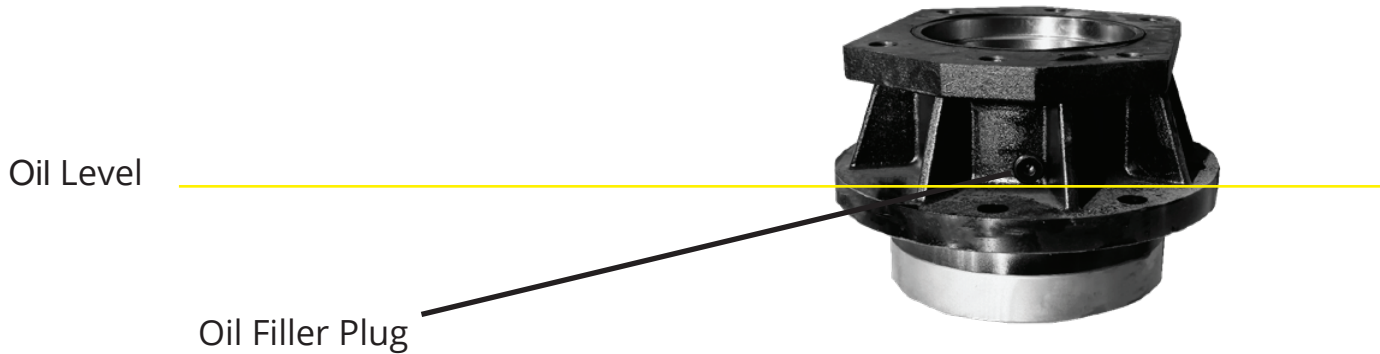

NOTICE

The initial oil should be changed after 50 hours of operation under load. Subsequent oil changes should take place after every 1000 hours of operation. More frequent oil changes may be necessary if operating this cutter in extreme hot conditions.

GEARBOX OIL CHANGE PROCEDURE

1. Remove oil filler plug and insert one end of a discharge hose into the oil filler port and the other end into an approved waste oil container.
2. Using an oil removal pump, remove the old oil from the gear box unit.
3. Refill with 85-140 grade gear oil until oil level is up to the bottom of the oil filler port.
4. Reinstall oil filler plug.

NOTICE

Properly dispose of used oil. Visit www.Earth911.com to search for the nearest used oil recycling center near you.

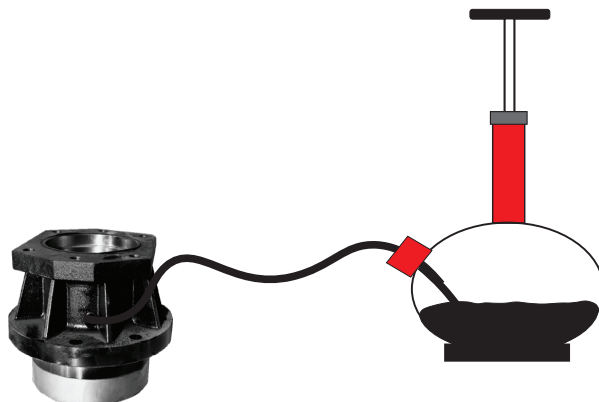

SECTION 5

TROUBLESHOOTING

PROBLEM	POSSIBLE CAUSE	SOLUTION
Machine loses power when operating stump grinder.	RPM's are not high enough. Hydraulic Flow is too slow or has a leak.	Increase RPMs and reduce ground speed. Look for hydraulic leaks & repair.
Stump Grinder becomes uneven.	Grinder receiving excessive shock loads from contacting solid objects (rocks, steel pipes, etc.) Grinder used on too powerful of a machine.	Clear the sweeping area of solid objects, raise grapple height to clear exposed rock surfaces. Use on the correct machine.
Hydraulic fluid level goes down during operation.	Hydraulic system leak, or leaks in host machine's hydraulic system.	Investigate and repair leaks.
Grinder does not move when hydraulic system is activated.	Incomplete circuit to & from machine. Cylinder failure.	Disconnect and reconnect hoses to machine. Replace cylinders.
Cylinder does not open or close.	Quick disconnects not connected. Hose damaged. Machine auxiliary circuit inoperative. Internal damage to the cylinder.	Check & Recouple Quick disconnects. Check for smashed or kinked hose & replace if found. Investigate and have repaired. Replace Cylinder.
Cylinder moves very slow	Restricted hose. Circuit relief on machine bad. Auxiliary valve spooling on machine not shifting properly. Cylinder seals by-passing.	Check for damaged hose between machine & cylinders. If damaged, replace. Investigate & have repaired. Investigate & have repaired. Have cylinder(s) repacked or replaced.

DANGER

ONLY service the attachment on stable, even terrain. NEVER park on sloped terrain to avoid being struck & killed or seriously injured by the unexpected rolling or movement of the machine.

SECTION 6

SPECIFICATIONS

MODELS	STG1727	STG2030	STG3044
TEETH QTY	30	30	30
MOTOR	RADIAL PISTON	PARKER BENT AXIS PISTON	RADIAL PISTON
GPM	17-27	20-30	30-44
WEIGHT	850 LBS	850 LBS	850 LBS
TEETH TYPE	900 SERIES WEAR-SHARP GREEN TEETH	900 SERIES WEAR-SHARP GREEN TEETH	900 SERIES WEAR-SHARP GREEN TEETH
CASE DRAIN	NOT REQUIRED	REQUIRED	REQUIRED
WHEEL DIAMETER	27.5 INCH	27.5 INCH	27.5 INCH
FITS ON	SKID STEER	SKID STEER	SKID STEER

STG 2030 DIMENSIONS

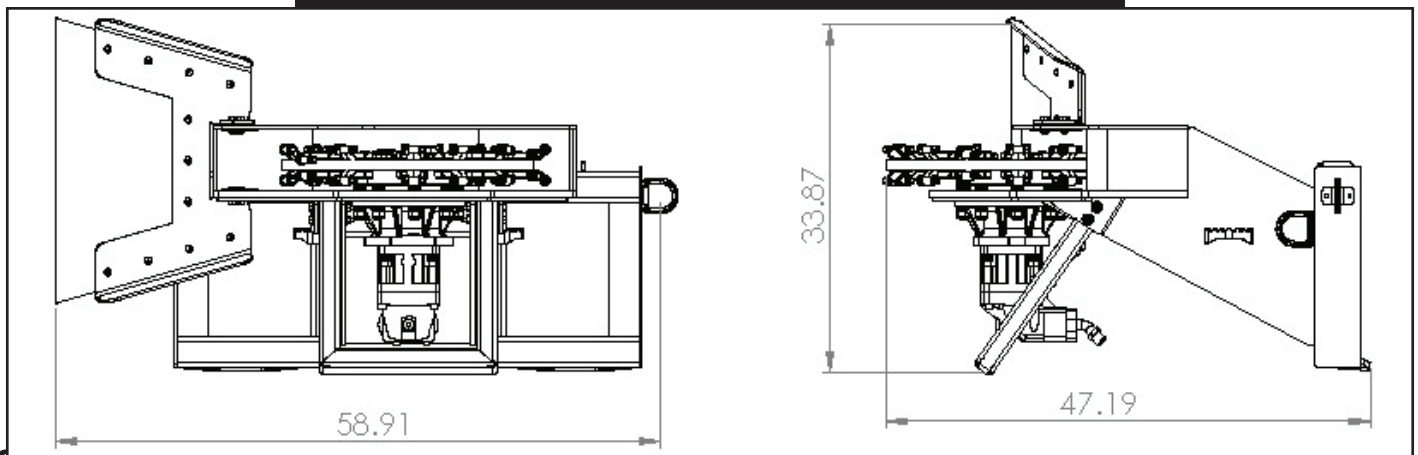

SECTION 7

PARTS INFORMATION

Factory fresh parts specifically designed for your implement are readily available.

For hassle free service and to ensure you receive the correct parts for your implement, please provide your dealer with the following information:

Model Number	
Serial Number	
GPM Requirements	
Date of Owners Manual (Bottom Left Corner of Cover Page)	
Parts Diagram Page Number	
Part Description	
Reference #	
Quantity Desired	
Ship To Information	
Bill To / Payment Information	

7.1 STUMP GRINDER BLADE ASSEMBLY DIAGRAM

Stump Grinder 24.5" Blade Assembly

ITEM	PART #	DESCRIPTION	QTY.
1	50100086	24.5" Blade Holder	1
2	11200886	Spacer	30
3	11200896	Nylon Locknut	30
4	11200906	Cutting Tooth	30
5	11200916	Pocket Holder Bolt	30
6	11200926	Teeth Holder Angled	24
7	11200936	Teeth Holder Reversed	2
8	11200946	Teeth Holder Straight	4

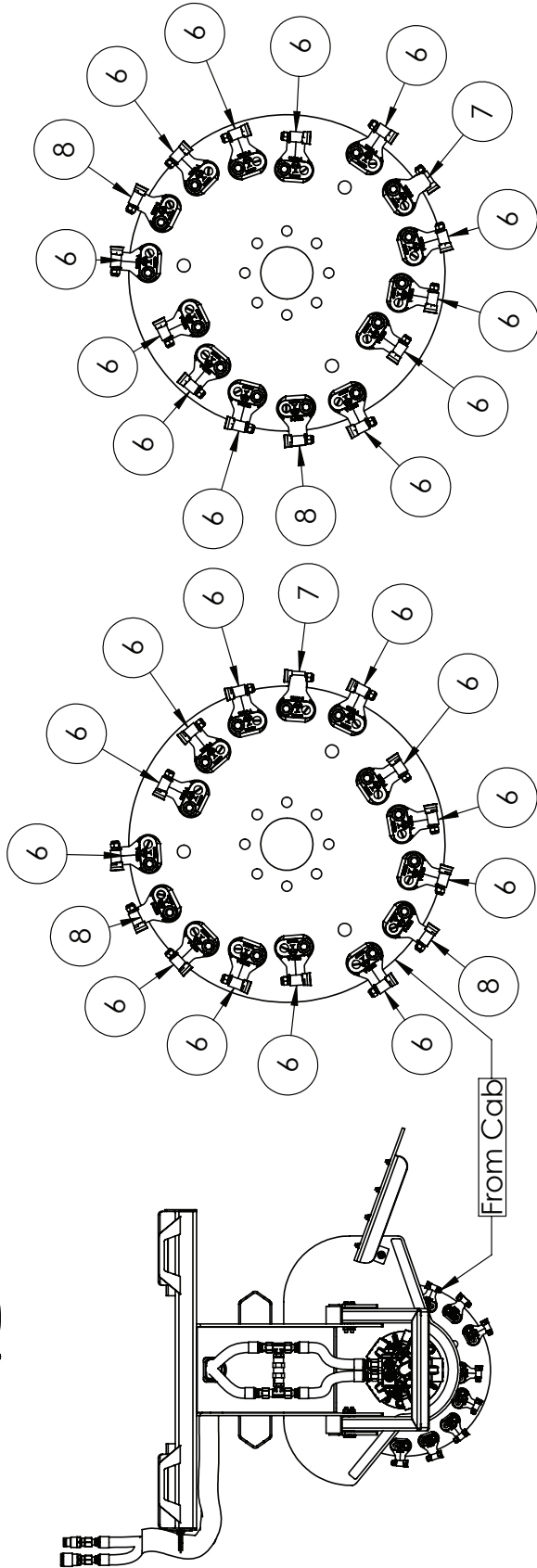
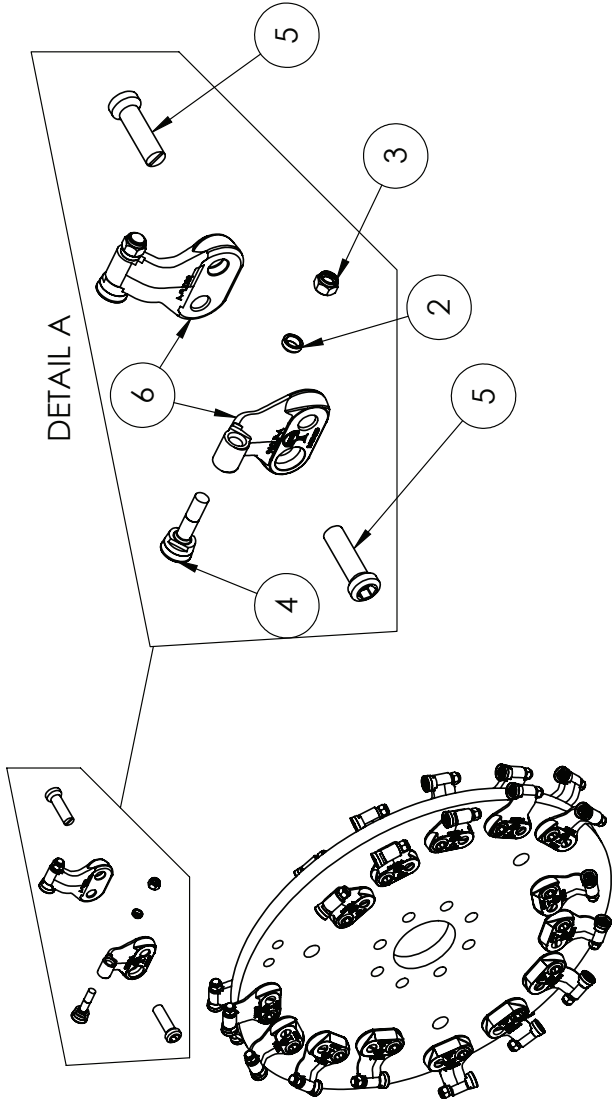

Opposite from Cab

7.2 STUMP GRINDER 17-27 GPM PARTS DIAGRAM

ITEM	Part #	DESCRIPTION	QTY.
1	40200066	Gearbox	1
2	51100016	Chip Guard Weldment	1
3	11200716	3/4" X 2 3/4" Socket Head Coarse Bolt	8
4	11200226	3/4" Split Lock Washer GR 8	8
5	11200216	3/4"-10 Lock Nut GR C	8
6	11200656	3/4"-16 X 2" Hex Bolt GR 8	8
7	11200236	3/4" SAE Flat Washer GR 8	8
8	11200466	7/16-14 LOCK NUT GR C	4
9	11200846	7/16"-14 X 4" HEX Bolt GR 8	4
10	11200856	5/16" X 1 1/4" Carriage Bolt	11
11	41400016	Guard Rubber	1
12	11200256	5/16"-18 USS Flat Washer GR 8	11
13	11200106	5/16"-18 Lock Nut GR C	11
14	11200356	1/2"-13 X 1 3/8" Hex Bolt GR 8	4
15	11200306	1/2" SAE Flat Washer GR 8 Z/YEL	4
16	81100236	Frame Weldment	1
17	81100246	Motor Protector	1
18	11200866	7/16" SAE Flat Washer GR 8	8
19	81100256	Blade Holder Assembly	1
20	40100106	Motor	1
21	11200876	1/2"-13 X 1 1/4" Socket Bolt	4
22	41000026	1 1/16" X 1 5/16" Motor Fitting	2
23	40600046	Check Valve	1
24	41000086	3/4" Tee Fitting	2
25	52400036	3/4" D X 8" L Hose	2
26	52800046	3/4" D X 9" L Machine Hose	1
27	41000116	1/2" Flat Coupler FE - Changeable	1
28	41000106	1/2" Flat Coupler M - Changeable	1
29	41000096	3/4" - 1/2" Straight Fitting	2

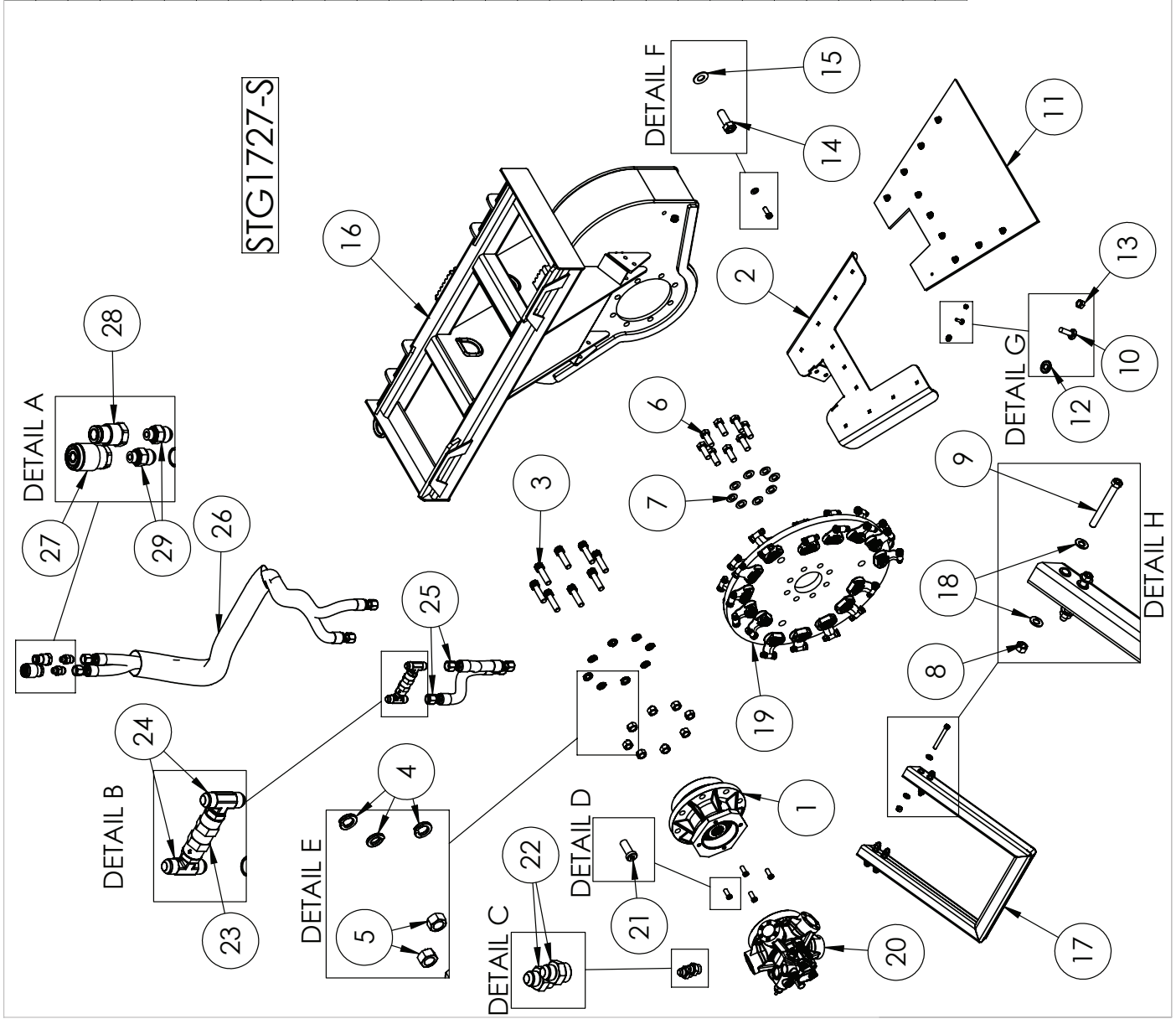

7.3 STUMP GRINDER 20-30 GPM PARTS DIAGRAM

ITEM	Part #	DESCRIPTION	QTY.
1	40200066	Gearbox	1
2	51100016	Chip Guard Weldment	1
3	11200716	3/4"X 2 3/4" Socket Head Coarse Bolt	8
4	11200226	3/4" Split Lock Washer GR 8	8
5	11200216	3/4"-10 Lock Nut GR C	8
6	11200656	3/4"-16 X 2" Hex Bolt GR 8	8
7	11200236	3/4" SAE Flat Washer GR 8	8
8	11200466	7/16-14 LOCK NUT GR C	4
9	11200846	7/16"-14 X 4" HEX Bolt GR 8	4
10	11200856	5/16" X 1 1/4" Carriage Bolt	11
11	41400016	Guard Rubber	1
12	11200256	5/16"-18 USS Flat Washer GR 8	11
13	11200106	5/16"-18 Lock Nut GR C	11
14	11200356	1/2"-13 X 1 3/8" Hex Bolt GR 8	4
15	11200306	1/2" SAE Flat Washer GR 8 Z/YEL	4
16	81100236	Frame Weldment	1
17	81100246	Motor Protector	1
18	11200866	7/16" SAE Flat Washer GR 8	8
19	11200956	1/2"-13 X 1 1/2" Socket Bolt	4
20	40100116	Motor	1
21	11200176	1/2" Split Lock Washer GR 8	4
22	41000336	Motor Fitting	2
23	41000276	3/8" Case Drain Fitting	1
24	81100256	Blade Holder Assembly	1
25	41000346	Motor Flange Kit	2
26	41000086	3/4" Tee Fitting	2
27	40600046	Check Valve	1
28	41000136	9/16" Straight Fitting	1
29	52400036	3/4" D 8" L Hose	2
30	52800056	3/4" D X 9' Machine Hose	1
31	41000126	3/8" Flat Coupler FE - Changeable	1
32	41000116	1/2" Flat Coupler FE - Changeable	1
33	41000106	1/2" Flat Coupler M - Changeable	1
34	41000096	3/4" - 1/2" Straight Fitting	2

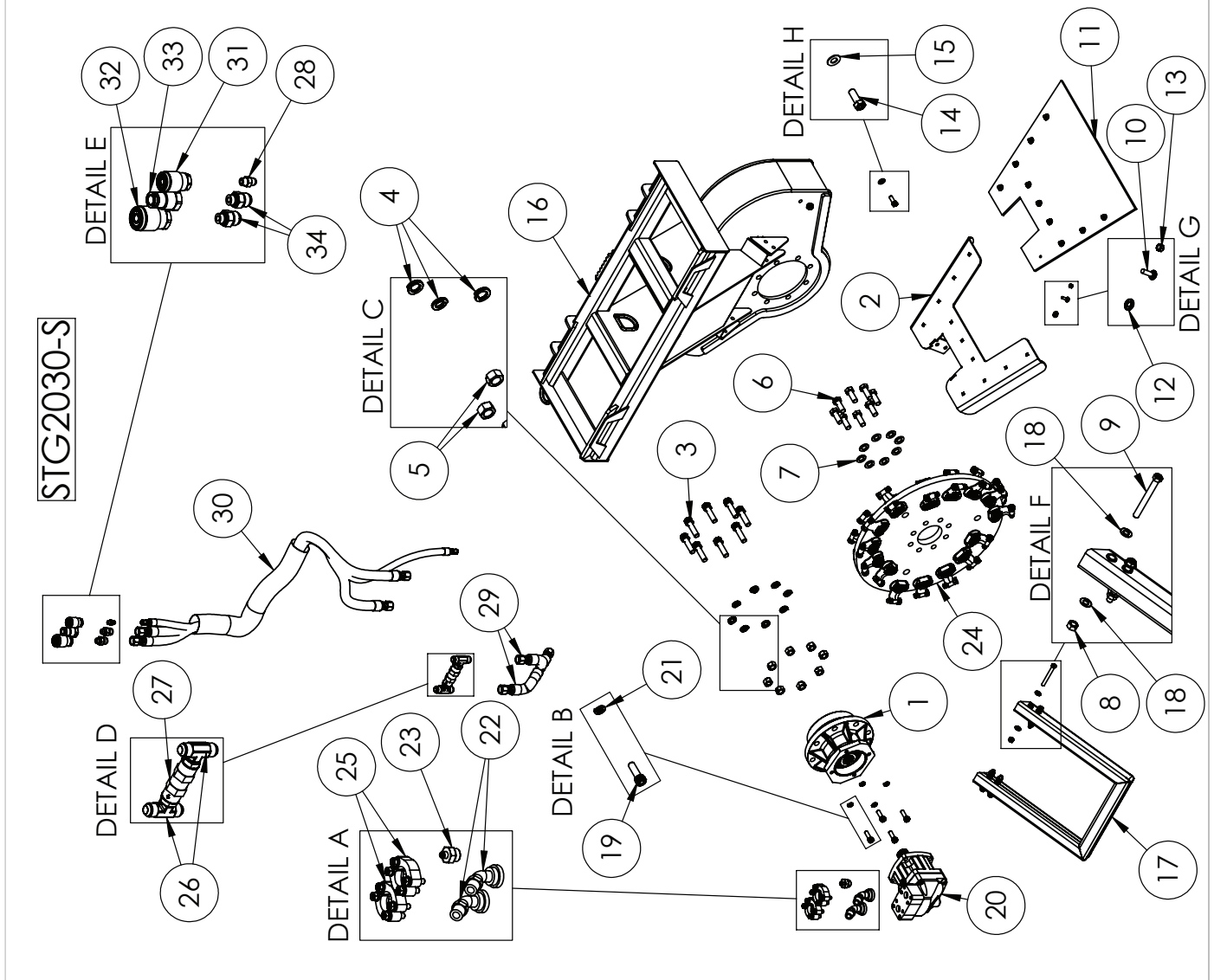

7.4 STUMP GRINDER 30-44 GPM PARTS DIAGRAM

ITEM	Part #	DESCRIPTION	QTY.
1	40200066	Gearbox	1
2	51100016	Chip Guard Weldment	1
3	11200716	3/4" X 2 3/4" Socket Head Coarse Bolt	8
4	11200226	3/4" Split Lock Washer GR 8	8
5	11200216	3/4"-10 Lock Nut GR C	8
6	11200656	3/4"-16 X 2" Hex Bolt GR 8	8
7	11200236	3/4" SAE Flat Washer GR 8	8
8	11200466	7/16-14 LOCK NUT GR C	4
9	11200846	7/16"-14 X 4" HEX Bolt GR 8	4
10	11200856	5/16" X 1 1/4" Carriage Bolt	11
11	41400016	Guard Rubber	1
12	11200256	5/16"-18 USS Flat Washer GR 8	11
13	11200106	5/16"-18 Lock Nut GR C	11
14	11200356	1/2"-13 X 1 3/8" Hex Bolt GR 8	4
15	11200306	1/2" SAE Flat Washer GR 8 Z/YEL	4
16	81100236	Frame Weldment	1
17	81100246	Motor Protector	1
18	11200866	7/16" SAE Flat Washer GR 8	8
19	81100256	Blade Holder Assembly	1
20	40100126	Motor	1
21	11200966	1/2"-13 X 1 1/4" Socket Bolt	4
22	41000026	1 1/16" X 1 5/16" Motor Fitting	2
23	41000076	1/4" Case Drain Fitting	1
24	52800066	3/4" D X 9' Machine Hose	1
25	41000086	3/4" Tee Fitting	2
26	40600046	Check Valve	1
27	41000046	3/4" Straight Fitting	2
28	41000226	3/4" Flat Coupler FE - Changeable	1
29	41000236	3/4" Flat Coupler M - Changeable	1
30	41000126	3/8" Flat Coupler FE - Changeable	1
31	52400036	3/4" D 8" L Hose	2

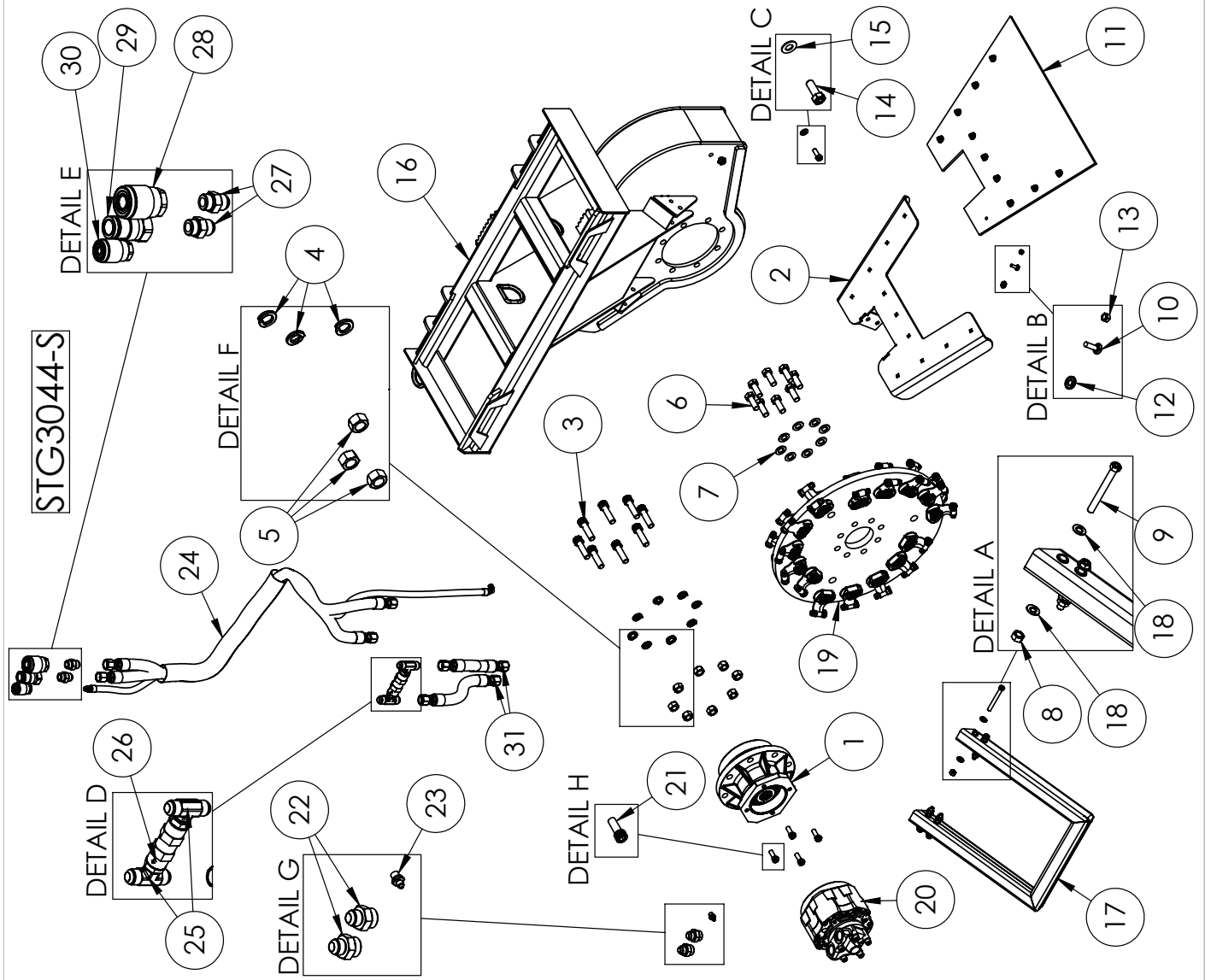

SECTION 8

WARRANTY INFORMATION

LIMITED WARRANTY

Construction Implements Depot, Inc. (CID) products are warranted to be free from defects in workmanship or materials for a period of 12 months from the initial sale.

WARRANTY EXCLUSIONS

This warranty does not cover normal wear items, including but not limited to: bearings, hoses, blade holders, ground engaging parts such as teeth, blades, cutting edges, pilot bits, auger teeth and broom bristles. This warranty does not cover maintenance, service or adjustments. This warranty does not cover damage due to improper application or installation, misuse, negligence, accidents or improper maintenance. Please note: Any modification or customization made to your attachment may void its warranty. This warranty is void if any components have been disassembled, i.e., pumps, gear boxes or motors or the attachment has been used without the case drain attached (if applicable). Be sure to follow all recommended Horsepower and GPM requirements as outlined in product specifications, in order to prevent the warranty from being void. This warranty is contingent upon the use of approved BRAND parts exclusively. Any use of non-approved parts may result in voiding the warranty. Please be advised that the warranty does not cover refurbished attachments. Specially modified attachments built by the manufacturer to meet your needs shall not be warranted by CID, Inc.

REPAIRS UNDER WARRANTY

Any repairs, including welding, on attachments must be performed by certified repair technicians who have requested and obtained written approval from an authorized representative of CID before repairs begin. If you are completing the repair, you must also have prior written approval to prevent the warranty from being voided.

WARRANTY STATEMENT

Our obligation under this Limited Warranty shall be solely limited to repairing or replacing any part (see non-covered items above) that, according to our judgment, show evidence of a defect in quality of workmanship or

8.0 WARRANTY INFORMATION CONT.

materials for the stated 12 month warranty period. All defective parts must be routed directly to CID, Inc. with freight or delivery charges to be prepaid. This limited warranty shall not be interpreted to render CID, Inc. liable for any injury or damage to persons, businesses or property of any kind nor expenses or losses incurred for labor, supplies, substitute machinery rental or for any other reason. Repair or replacement parts are subject to the supply conditions at the time of repair or replacements, which may directly affect our ability to obtain material and/or replacement parts. CID, Inc. reserves the right to make improvements in design or changes in specifications at any time without incurring any obligations to owners of previously purchased products. No one but CID, Inc. is allowed to alter, modify or enlarge this warranty nor the exclusions, limitations and reservation at any time. CID, Inc. products are warranted to be free from defects in workmanship or materials for a period of 12 months from the initial sale.

Purchaser and Manufacturer hereby (a) submit to the non-exclusive jurisdiction of the courts of competent jurisdiction in North Carolina and Davidson County in which this company resides for resolution of any dispute concerning this Limited Warranty or the rights or obligations of Purchaser and/or Manufacturer; (b) agree that any litigation in connection with this Limited Warranty shall be venued in North Carolina and Davidson County in which the company resides and (c) waive any objection they may have as to any such action or proceeding brought in such court that such court is an inconvenient forum. Nothing herein shall limit the right of Purchaser or Manufacturer (or the right of any permitted successor or assign of either) to bring proceedings against the other in the courts of any other jurisdiction wherein any assets of such other party may be located.

8.1 WARRANTY RETURN AUTHORIZATION POLICY

WARRANTY RETURN AUTHORIZATION POLICY:

If repairs are required, a Return Material Authorization (RMA) number must be obtained for the defective part as well as proof of purchase. RMA and services are rendered by CID only. Any responsibility of shipping costs on any item returned for repair is at the discretion of CID, Inc.

All returned parts must have the following:

1. A legible RMA number written on the outside of the package.
2. Warranty Claim Form (online)
3. The defective part.

RMA numbers are only valid for 30 days from the date of issue. All shipped replacement parts will require a Parts Order (PO) number from the original CID, Inc dealer. Repairs not covered by the warranty, will be charged for parts and labor at the current pricing rate. Should you have any problems with your attachment, please follow the instructions listed on the following page.

8.2 WARRANTY PROCEDURE

WARRANTY RETURN AUTHORIZATION PROCEDURE:

1. Call the Warranty Department at (336) 859-2002 EXT 215. You will need to provide the model and serial number of the defective item(s) (see Appendix for where to find this information), a description of the problem, and have photographs available.
2. Upon a warranted issue, visit www.cidattachments.com, click on the warranty tab, and fill in the warranty information on the Warranty Claim Form.. CID, Inc will retain a Return Material Authorization (RMA) number of the defective part. If all the information above is completed CID, Inc will issue a RMA number via email..
3. Once you have an approved RMA number, a shipping label will be provided with CID's address and instructions for returning the defective part. **Appropriate RMA's/PO's will be invoiced and payment received while the evaluation process is being completed to prevent delays in your normal business operations. In the event the defective part(s) is un-warranted and repairs are not covered by the warranty, the customer will be invoiced for any additional parts and labor at the current pricing rate. If the part is deemed under warranty, a credit of the invoice will be issued.**
4. CID will ship a replacement part to the provided location or customer with a RMA identifier of some kind. **The customer is responsible for initial shipping charges until evaluation of the part has been completed.** If the part failure is covered by the warranty, the customer will be reimbursed for any paid shipping charges. In the event, the part is not covered by the warranty, the customer is responsible for return shipping.
5. Once the defective part is warranted by CID, the customer will be issued a credit and the PO number will no longer be active.
6. In the event CID decides that the attachment needs to be returned to them for repair, CID will make arrangements for pickup and return. Repairs will be performed by CID qualified technicians. Non-warranted issues will be discussed, and repairs will be performed upon the owner's agreement and receipt of payment for parts and labor.

SECTION 9

SAFETY ACKNOWLEDGMENT

ATTENTION ALL OPERATORS: Print your name, sign and date in the boxes below to acknowledge that you have read and fully understand the safety instructions presented in this manual, and have been trained on how to safely operate this attachment.

OPERATOR NAME	SIGNATURE	DATE

MAINTENANCE LOG

Use this log sheet to document all routine maintenance and repair services performed on this attachment.

DESCRIPTION OF MAINTENANCE/REPAIR	SERVICED BY:	DATE:

APPENDIX A FINDING YOUR MODEL AND SERIAL NUMBER

The Model and Serial numbers will be in one place and will either be etched into the attachment or on a Data Plate.

Instructions: Stand at the back of the attachment facing the attachment mounting bracket and look in the following locations:

1) Back- top left area

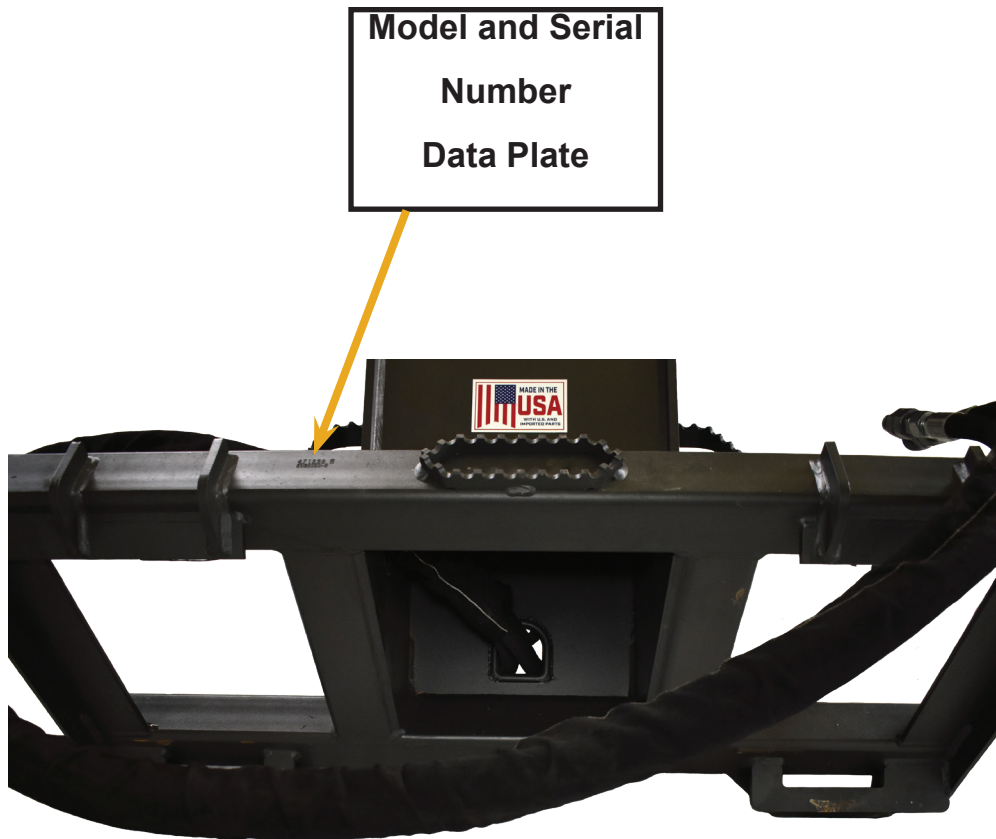

PLEASE NOTE: The Model and Serial number may be etched or on a Data Plate.

Disclaimer: Any critical changes made to this manual by individuals outside the manufacturer's authorized personnel are doing so at their own risk. The manufacturer cannot be held legally responsible for any consequences, damages, or liabilities resulting from such modifications. It is advised to adhere strictly to the original manual provided by the manufacturer for optimal performance, safety, and reliability.



TRUSTED ATTACHMENTS



EST.

CID

2003

INDUSTRIAL QUALITY

**CONSTRUCTION IMPLEMENT DEPOT
DENTON-USA, LLC
1248 N. MAIN ST
DENTON, NC 27239**

www.CIDATTACHMENTS.COM



CIDSTG-MANU-V2M1024