

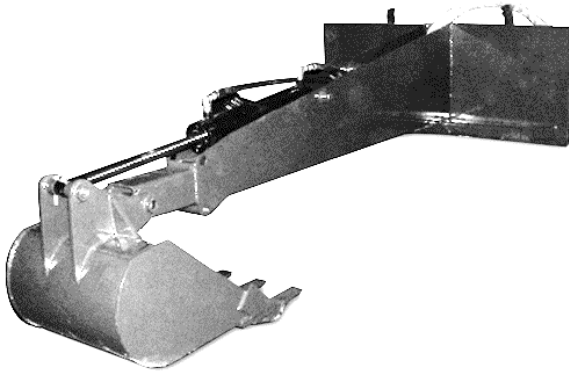

X-treme Stiff Arm Backhoe



Owner's/Operator's Manual



WARNING

For safe operation, read these rules and instructions carefully to avoid accidents that could result in Death or Serious Injury.

TO THE OWNER/OPERATOR OF THIS IMPLEMENT

Please read this manual "before" unpacking or using this implement for the first time. This manual provides you with the necessary instructions to safely install and use your purchase. Do not let other people use this attachment without first being instructed how to safely use it.



Construction Implements Depot, Inc

1248 N. Main Street
Denton, NC 27239
(336) 859-2002

Save this manual for future reference!

Thank You

Our sincere appreciation to you on the purchase of a quality Stiff Arm Backhoe designed and manufactured in the USA by Construction Implements Depot, Incorporated. Product experience of a combined 30 years is the cornerstone of our company, and our goal is to provide you with a heavy duty product that will give you years of satisfaction and operation.

Our record of successful and satisfied customers is evidence of the concern for quality and designed strength that we place into each and every product we build.

As this manual expresses the need for safe operation of your acquisition from Construction Implements Depot, Inc, it is important that you and all operators of this implement become familiar with the operation, maintenance and safety instructions found in this manual, as well as in the manual that accompanied the skid steer machine that will power this attachment. Add some common sense to the items mentioned in these manuals as the recipe for safe operation.

We invite you to look at more innovative products on our web site:
<http://www.cidattachments.com> or if in the area stop and visit our modern manufacturing facilities located in Denton, NC.

Sincerely,
Management & Employees
Construction Implements Depot, Inc.

Information

Record product information here for future reference.

Model _____
S/N or MFG. Date _____
Bucket Size: 8" _____ 12" _____ 16" _____
20" _____ 24" _____
Dealer Name _____
Dealer Phone ____ - ____ - _____
Date of Purchase __/__/_____

Table of Contents

Orientation	3
Importance of Safety	3
Operator Safety Training Tips	4
Unpacking Your Shipment	5
Using Your Implement	5
Connecting Backhoe to Skid Steer..	5
Backhoe Controls	6
Using Auger the First Time	6
Getting Familiar with the Attachment	6
Before Digging	7
Digging Tips	7
Maintaining your Attachment	8
Before Every Use	8
Every Week	8
After Every Season	8
Specifications.....	8
Parts.....	9
Backhoe Parts.....	10
Decals.....	11
Limited Warranty.....	12

Orientation

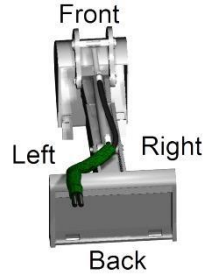

Serial Number Plate is Located on Top of Mounting Plate

Importance of Safety

Accidents can be very costly to human life and property. As the operator is the #1 safety device on all types of vehicles or equipment, it is important that the operator read, learn and know all safety recommendations for this product. The user is responsible to his family, friends and co-workers to operate in a safe manner. Ensure that everyone who operates or assists in the operation or maintenance of this product read and understand all the elements required to safely operate this piece of equipment.

This attachment has pinch points that include additional dangers.

Throughout this manual you will find safety notes which are very important to read and understand before operating this piece of equipment. These classifications alert you to situations that could be harmful to you or bystanders. When you see these alerts in the manual, carefully read and follow all instructions and also protect other workers from the same danger.

 **DANGER** Will result in Death or Serious Injury.

 **WARNING** Could result in Death or Serious Injury.

 **CAUTION** Could result in Minor or Serious Injury.

 **NOTICE** Not related to Personal Injury.

Operator Safety Training Tips

It is the responsibility of the operator using this attachment to be acquainted with the safe operation. In addition to reading this manual, it is important that the operator read the skid steer's operation manual and follow its manufacturer's recommendations!

 Know the area before digging. Always contact your local "Diggers Hotline" or "One-Call" to have underground utilities marked.

 Before raising, lowering or swinging the machine & backhoe, make sure area is clear of bystanders or objects.

 Machinery parts sometimes have sharp edges. Wear work gloves when moving parts.

 Never use drugs or alcoholic drinks when operating or servicing this piece of equipment.

 Always wear the proper personal protection equipment when servicing or operating this piece of equipment. Never service or operate this attachment with bare feet, sandals, or other light footwear.

 Always use eye protection during operation.

 Speed Kills! Operate this implement at a safe working speed. When transporting the implement, keep a safe speed to avoid losing control of the attachment or prime mover.

 Keep proper clearance between the implement and objects (tree stumps, large rocks, buildings, etc.). Contacting these objects with the implement or prime mover could cause a loss of control or damage to the implement.

 Before each operation of this implement, check all hardware (bolts, nuts, pins, cotter pins, etc.) for their proper location and tightness.

 Stop the engine on the skid steer and set the brake to avoid the implement rolling forward or backwards while you are exiting the prime mover.

 Store this implement in an area not frequented by children.

 Allow no riders on this attachment. Keep all bystanders clear of attachment during operation.

 Always replace worn, torn or missing safety decals before operating.

 Never operate the backhoe when bystanders are within 20 feet (6 m) of the work area.

Skid Steer Requirements

Your backhoe attachment is compatible with attachment couplers from all major skid steer manufacturers. This backhoe should only be used on skid steers with a compatible attachment coupler.

A skid steer equipped with tracks will provide superior traction in this application.

⚠ CAUTION *Make sure your skid steer is in good working condition. Follow the operating instructions found in the manual that accompanied your skid steer. Failure to do so could result in Minor or Serious Injury.*

Unpacking Your Shipment

Your attachment arrives from the factory banded to a wooden pallet, and requires no final assembly.

⚠ CAUTION *Careless removal of the shipping bands that secure the implement to the pallet could result in Minor or Serious Injury. Clear the area of all bystanders and stand to the side when cutting the bands with a pair of sheet metal shears.*

Using Your Implement

Connecting Backhoe to Skid Steer

⚠ DANGER *Never enter the area underneath the coupler or any part of the attachment when it is in the raised position to avoid an*

accident that will result in Death or Serious Injury.

Verify that the hydraulic hoses are clear from the front of the attaching plate on the attachment and that the mounting plate is free from dirt and debris. When clear, move the skid steer to proximity of attachment plate. Tilt skid steer coupler forward to align coupling point with the upper part on the attachment plate and raise the coupler slightly.

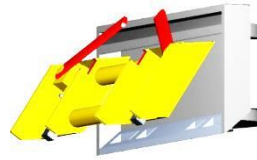

Connecting Coupler to Attachment

When the top edge of the coupler is seated in the top part of the coupler plate, roll the skid steer tilt function back until the attaching plate is flat against the skid steer coupler. Lock down the coupler levers.

PLEASE NOTE:
Attachment and Machine-side Couplings must be **FREE OF DEBRIS BEFORE INSTALLING.**
Failure to comply will void warranty.

NOTICE *Wipe off any dirt or dust from the male or female hydraulic flat-face couplers with a clean rag before attaching hoses, to keep contaminants from entering the hydraulic system. .*

Connect the backhoe hydraulic hoses to the auxiliary circuit connectors on the skid steer.

Check the surrounding area for bystanders and clear them before starting the skid steer or attachment.

Before operating the attachment, always visually inspect and verify that the coupler lock pins are fully engaged through the latch slots on the attachment plate.

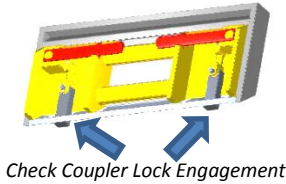

Backhoe Controls

The Stiff Arm Backhoe uses the loader arm lift and the attachment tilt controls of the skid steer loader. Consult your skid steer operator's manual for instructions on how to operate the lift and tilt controls.

Swinging the back hoe to one side or the other relies on the skid steer motion of the prime mover. To move the backhoe arm to the right, counter-rotate the skid steer to the right using the skid steer's drive controls. To move the backhoe arm to the left, counter-rotate the skid steer to the left using the skid steer's drive controls.

The auxiliary hydraulic control of the skid steer loader will provide hydraulic fluid to make the bucket curl in or curl out.

With practice, the operation of all the functions listed above will provide an easy means to dig a trench or a hole.

Using Auger the First Time

NOTICE *If this is your initial startup with this attachment on this machine, check the skid steer's*

hydraulic oil level and add oil, if necessary, before and after doing steps 1- 3 below.

After starting skid steer, lift the attachment 36" (915mm) off the ground surface:

1. With the skid steer engine RPMs just above idle, engage the auxiliary hydraulic flow to the bucket circuit. Rotate the bucket back and forth several times to eliminate any air in the circuit.
2. Return backhoe to the level position and rest the attachment bucket on the ground.
3. Shut off the skid steer's engine and exit the operator's compartment.
4. Check the skid steers hydraulic oil level, and add oil if necessary.
5. Inspect the backhoe's hydraulic plumbing for any noticeable leaks. Correct these leaks before continuing.

Getting Familiar with the Attachment

⚠ DANGER *Never operate the backhoe when bystanders are within 20' (6 m) of your work area. Flying debris or trench cave-in could result in Death or Serious Injury.*

⚠ CAUTION *Be cautious when operating on un-level ground surfaces. A machine roll over could result in Minor or Serious Injury. Always wear your seat belt when operating this attachment.*

Before starting the skid steer engine with this backhoe attached, make sure you are knowledgeable and comfortable with the operation of the skid steer controls as outlined in the skid steer's Operator's Manual.

When operating the backhoe, set the skid steer throttle at a speed that provides the necessary power to lift the backhoe and counter-rotate the drive tires at the same time. Note: It is not necessary to operate this attachment with the skid steer's throttle at the full open position.

Learn what the backhoe bucket looks like in a level digging position when you are seated in the skid steer. Knowing what a level bucket looks like will help you maintain a level bottom during a trenching operation.

Before Digging

⚠ WARNING *Before digging into any surface, always contact the "Diggers Hotline" to identify underground utilities to avoid an accident that could result in Death or Serious Injury to the operator or fellow workers.*

Section your intended work area off with cones and yellow barrier tape that includes not only the trenching area, but also the complete swing radius of the attachment. Stop operating if anyone steps inside the designated safety zone.

Digging Tips

⚠ WARNING *Exposure to crystalline silica dust along with other hazardous dusts may cause serious or fatal respiratory disease. Wear a dust mask whenever working in dusty environments.*

⚠ CAUTION *Never operate this attachment when bystanders are in proximity of the work area that could result in Minor or Serious Injury from flying debris or trench wall cave-in.*

1. Operate at a safe -paced speed that will allow you to watch the area being excavated and the area around the skid steer.
2. Make sure you are operating the skid steer's engine at an rpm that will produce the volume of oil flow required for this attachment and skid steer's drive circuit. In most instances, your engine's RPMs will be set at about half speed.
3. Do not use this attachment to "push" down trees.
4. Listen to your skid steer. If the bucket circuit stalls, you may be taking too big of a bite. Lift the boom slightly and attempt to curl the bucket again, taking a smaller bite.
5. Use a combination of loader arm and attachment plate tilt and bucket curl to fill the bucket. With practice, using all three functions simultaneously will result in a level trench bottom.



Trenching

6. You may also use the skid steer (reverse) drive system to help fill the bucket once the bucket has been lowered into position.
7. Lift the attachment above the ground surface before swinging backhoe with the skid steer drive system.
8. To swing the backhoe to the right, use the skid steer drive system to smoothly counter-rotate in the desired direction.
9. Avoid excessive side loading on this attachment.

Maintaining your Attachment

⚠ CAUTION *Not maintaining your implement correctly could result in Minor or Serious Injury. Keep your implement in top operating condition.*

Before Every Use

Check that all fasteners (nuts, bolts, pins, keepers) are in their right place and are tight.

Inspect and replace any worn, torn or missing safety decals.

Pump No. 2 lithium or molybdenum disulfide grease into all required areas until you see old grease is being flushed out.

Investigate the location of any oil leaks and repair.

After every use, clean off any dirt residue with a garden hose and repeat grease application.

Every Week

Inspect the bucket teeth and replace any worn or broken teeth.

After Every Season

Inspect the implement for any loose or worn parts that may need to be replaced prior to the next season.

Clean, sand & repaint any area that looks worn or scratched to prevent further rusting. Use an equipment-paint found at your local hardware store or building center.

Lubricate all pivot joints. If located in an area near an ocean or other corrosive conditions, apply a thin layer of grease to any exposed cylinder rod surfaces. Wipe grease from cylinder rods with a clean rag when taking the attachment out of storage.

Store your implement in a shed or cover with a water-proof tarp to protect it from the weather. Store in an area not frequented by children.

Specifications

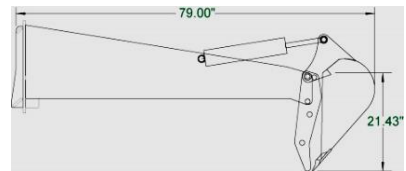

Spec.	Measurement
Attachment Length	79" (2006mm)
Dig Depth	7' (2.13m)
Attachment Weight less Bucket	500 lbs. (227 kg)
Bucket Weights:	
8"	65 lbs. (30 kg)
12"	100 lbs. (45 kg)
16"	125 lbs. (57 kg)
20"	150 lbs. (68 kg)
24"	175 lbs (79 kg)

Parts

When requiring any parts for your implement, please collect the following information:

- Implement Model Number
- Implement Serial Number
- Parts Manual Date (lower right corner)
- Parts Manual Page
- Part Description
- Quantity Required
- Ship-to Name & Address
- Payment Method

...then call your local dealer for factory fresh parts specifically designed for your attachment.

Backhoe Parts

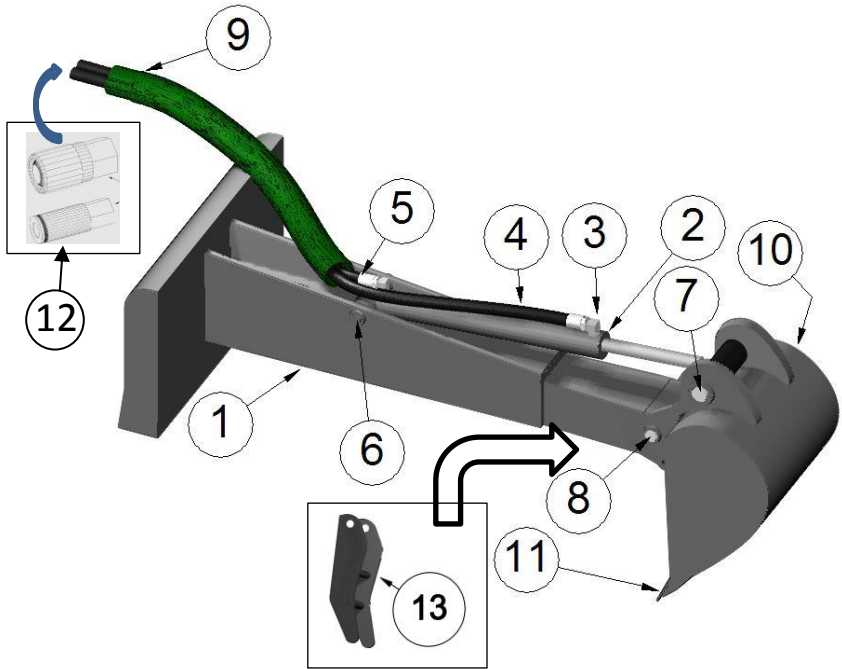

Ref.	Description	Qty.
1	Main Frame	1
2	Tool Cylinder	1
3	Fitting, 90°	2
4	Hose (Rod end of Cylinder to Loader)	1
5	Hose (Base end of cylinder to Loader)	1
6	Pin, (Cylinder base end to frame)	1
7	Pin, (Cylinder rod end to bucket)	1
8	Pin, (Bucket pivot)	1
9	Sleeve, Protective (slides over hoses)	1
10	Bucket 8"	1
	Bucket 12"	1
	Bucket 16"	1
	Bucket 20"	1
	Bucket 24"	6
11	Tooth, Bucket	AR
12	Quick Disconnect Coupling Set	1
13	Thumb (Optional) Kit	1

Decals

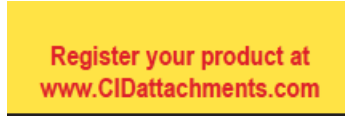
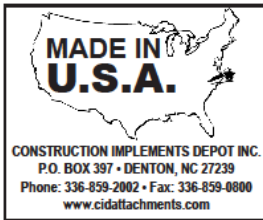

For warranty information
call your dealer or go to
www.CIDattachments.com/CID_warranty.html



Ref.	Description	Qty.
1*	Decal, (Danger Pinch Point)	1
2*	Decal, (Warning, High Pressure Fluid Hazard)	1
3	Decal, Made in the USA	1
4	Decal, Registration & Warranty Info	1
5	Decal, Construction Implements Depot, Inc.	1
6	Decal, Clean debris from hydraulic couplers	1

* **WARNING** Replace any worn, torn or missing safety
decals before operating.



Owner's Manual **Stiff Arm Backhoe**

**1248 N. Main
PO Box 397
Denton, NC 27239**

Website
www.cidattachments.com
For More Information, Contact
sales@cidattachments.com
Phone: (336)859-2002

Limited Warranty

Construction Implements Depot, Inc. products are warranted to be free from defects in workmanship or materials for period of (12) months from initial sale, lease or rental date.

Warranty Exclusions

This warranty does not cover normal wear items, including but not limited to, bearings, hoses, ground engaging parts such as, teeth, blades, cutting edges, pilot bits, auger teeth and broom bristles. This warranty does not cover maintenance, service or adjustments. This warranty does not cover damage due to misuse, negligence, accidents, or improper maintenance. This warranty does not cover damage due to improper application, installation, contamination, adjustment or setup. This warranty does not cover improper modifications of product. This warranty is void if any components have been disassembled, i.e. pumps, gear boxes, motors.

Specially modified attachments built by CID X-treme Attachments to meet your customer's needs shall not be warranted by Construction Implements Depot, Inc. This warranty does not cover replacement parts not supplied by CID, Inc.

Warranty Statement

Our obligation under this Limited Warranty shall be solely limited to repairing or replacing any part (see non-covered items) free of charge that, according to our judgment, show evidence of a defect in quality of workmanship or materials for the stated (12) month warranty period. All defective parts must be routed directly to CID, Inc. with freight or delivery charges to be prepaid. This Limited Warranty shall not be interpreted to render CID, Inc. liable for any injury or damage to persons, business or property of any kind nor expenses or losses incurred for labor, supplies, substitute machinery rental, or for any other reason. Repair or replacement parts are subject to the supply conditions at the time of repair or replacements, which may directly affect our ability to obtain material and/or replacements parts. CID, Inc. reserves the right to make improvements in design or changes in specifications at any time without incurring any obligations to owners of previously purchased units. No one but CID, Inc. is allowed to alter, modify or enlarge this warranty nor the exclusions, limitation and reservation at any time.