

Instructions for Use and Technical Description



reddot award 2017
winner



AVE2

Birthing bed



D9U004PPB-0101

Version: 12

Date of publication: 2024-01

Manufacturer:

BORCAD Medical a.s.
Fryčovice 673
739 45 Fryčovice
Czech Republic

Tel.: +420 312 576 111

Fax: +420 312 522 668

E-mail: borcadmedical@borcadmedical.com

www.borcadmedical.com

Authorised Distributor:

Crescent Healthcare
26 Metrolink Circuit
Campbellfield, Victoria, 3061

Tel.: 1300 04 05 06

Fax: 1300 04 05 07

E-mail: sales@crescenthealthcare.com.au

www.crescenthealthcare.com.au



LINET

AVE2

Birthing bed

Author: BORCAD Medical a.s.

Related links: www.linnet.com/cs/borcad-medical

D9U004PPB-0101

Version: 12

Date of revision: 2024-01

Copyright © L I N E T, s.r.o., 2024

Translation © L I N E T, s.r.o., 2024

All rights reserved

All trademarks and brands are the property of the appropriate owners. The manufacturer reserves the right to changes in the contents of this manual that relate to the product's technical regulations. It is for this reason that the contents of this manual may indicate differences from the current manufacture of the product. Reproduction (including excerpts from this text) is permitted only with the prior permission of the publisher. This text is subject to change due to technical developments. All technical data are rated data are subject to construction and manufacturing tolerances.

Table of content

| | | | |
|--|-----------|--|-----------|
| Introduction..... | 6 | 9 Operating the bed..... | 42 |
| 1 Symbols and Definitions..... | 7 | 9.1 Side rails | 42 |
| 1.1 Symbols on the package | 7 | 9.1.1 Description of the control panel for the woman in childbirth | 43 |
| 1.2 Symbols on the birthing bed | 8 | 9.1.2 Adjustment of the handle in inactive position | 43 |
| 1.3 Symbols on the leatherette upholstery | 12 | 9.1.3 Adjustment of the handle in active position | 43 |
| 1.4 Symbols on the DUOCOAT mattress set | 12 | 9.2 Side control panel | 44 |
| 1.5 Symbols on the terry cloth sheet | 13 | 9.3 Manual setting of the CPR..... | 45 |
| 1.6 Production label with UDI | 14 | 9.4 Electric setting of Trendelenburg | 46 |
| 1.7 Acoustic signalisation | 15 | 9.5 Setting of the foot section | 47 |
| 1.8 Abbreviations | 15 | 9.5.1 Folding/unfolding | 48 |
| 2 Un-packing manual | 16 | 9.5.2 Lifting/lowering..... | 49 |
| 3 General safety..... | 23 | 9.5.3 Tilting up/down..... | 50 |
| 3.1 Mechanical safety | 25 | 9.6 Adjusting the leg rests | 51 |
| 4 Overview of basic parts | 26 | 9.6.1 Gynaecological position..... | 52 |
| 4.1 Overview of basic versions | 27 | 9.6.2 Foot rest position | 54 |
| 4.2 Overview of colour versions..... | 27 | 9.6.3 Maximum bed surface position | 56 |
| 4.3 Safety..... | 27 | 9.6.4 Turning the leg rests sideways | 57 |
| 5 Function | 28 | 9.6.5 Leg rest tray adjustment | 58 |
| 5.1 Interaction | 28 | 9.6.6 Leg rest tray height adjustment | 59 |
| 5.2 General instructions..... | 28 | 9.6.7 Leg straps | 60 |
| 5.3 Application environment 5 | 28 | 9.7 Backup Battery | 61 |
| 6 Intended use | 29 | 9.8 Grab handles, detachable (R/L)..... | 62 |
| 6.1 User population..... | 29 | 9.9 Grab handles, non-detachable, foldable (R/L) | 63 |
| 6.2 Contraindications..... | 29 | 9.10 Holder of infusion stand | 63 |
| 6.3 Operator..... | 29 | 9.11 Equipotential coupling..... | 64 |
| 7 Technical Specification..... | 30 | 9.12 Replaceable leatherette upholstery / mattress set DUOCOAT..... | 64 |
| 7.1 Identification of Applied Parts | 30 | 9.12.1 Leatherette upholstery | 65 |
| 7.2 Technical parameters..... | 31 | 9.12.2 DUOCOAT mattress set..... | 65 |
| 7.3 Electrical parameters | 32 | 10 Accessories | 66 |
| 7.4 Technical specifications of the DUOCOAT mattress set..... | 33 | 10.1 Cable hand controller..... | 66 |
| 7.5 Transport instruction, Storage instruction | 33 | 10.2 Supporting bar | 67 |
| 7.6 Electromagnetic compatibility | 34 | 10.3 Undercarriage light | 67 |
| 7.6.1 Manufacturer instructions – electromagnetic emissions | 34 | 10.4 Infusion stand, stainless steel, telescopic | 68 |
| 7.6.2 Manufacturer instructions – electromagnetic susceptibility | 35 | 10.5 Eurolath along the seat section | 68 |
| 8 Setting the product..... | 37 | 10.6 Rear bed-head..... | 68 |
| 8.1 Transport, braking..... | 38 | 10.7 Doctor's chair (ergonomic)..... | 69 |
| 8.2 Transport..... | 40 | 10.8 Doctor's chair..... | 69 |
| | | 10.9 Front bumper on foot section..... | 69 |
| | | 10.10 Upper mattress (for 100 mm cushioning) | 70 |
| | | 10.11 Upper mattress (for 130 mm cushioning) | 70 |



| | | |
|-----------|---|------------|
| 10.12 | Tray on the swinging holder..... | 70 |
| 10.13 | Nurse call..... | 71 |
| 10.14 | Front bumper fitted on the leg rest (R/L)..... | 72 |
| 10.15 | Head rest | 72 |
| 10.16 | Bowl | 72 |
| 10.17 | Instrument tray..... | 73 |
| 10.18 | Protractor of the seat part, Protractor of the back part | 73 |
| 10.19 | Bracket for oxygen bottles | 73 |
| 10.20 | Patient card..... | 75 |
| 10.21 | Baby plate..... | 75 |
| 10.22 | USB cell-phone recharger | 78 |
| 11 | Cleaning and disinfection..... | 79 |
| 11.1 | Cleaning the birthing bed..... | 81 |
| 11.1.1 | Recommended disinfection (disinfectants for wiping) | 85 |
| 11.2 | Cleaning the leatherette upholstery . | 86 |
| 11.2.1 | Recommended disinfection of leatherette upholstery | 86 |
| 11.3 | Cleaning the DUOCOAT mattress set..... | 86 |
| 11.3.1 | Recommended manual cleaning and disinfection of the top cover..... | 88 |
| 11.3.2 | Recommended cleaning of the top cover in an industrial laundry | 89 |
| 11.3.3 | Recommended chemical concentrations for disinfection the top cover | 94 |
| 11.3.4 | Recommended chemical concentrations for disinfection the inner covers | 95 |
| 11.4 | Covering the birthing bed for use..... | 96 |
| 11.4.1 | How to properly coat bed with hospital bedding..... | 96 |
| 11.4.2 | How to properly coat bed with Disposable bed sheets | 97 |
| 11.4.3 | How to properly coat bed with terrycloth | 98 |
| 12 | Maintenance..... | 99 |
| 12.1 | List of error, malfunction and generated messages | 99 |
| 12.2 | Service and repairs..... | 100 |
| 13 | Environmental protection and liquidation of the product | 101 |
| 14 | List of available equipment | 102 |

Introduction







Please read carefully the whole instruction manual, which is designed to familiarize you with the correct use and the parameters of your new birthing bed. Please always follow the instructions contained in this manual and use the bed only in accordance with these instructions.

Please keep these instructions near the bed throughout its operation. Every person operating the birthing bed AVE2 must read and understand the contents of these instructions.



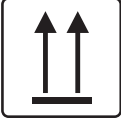







1 Symbols and Definitions









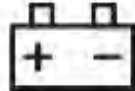

| | |
|---|--|
|  | <p>WARNING: DANGEROUS ELECTRIC VOLTAGE</p> |
|  | <p>WARNING: CAUTION</p> |
|  | <p>THIS SYMBOL INTRODUCES ANY INFORMATION THAT MAY HELP YOU AVOID OPERATIVE PROBLEMS</p> |

1.1 Symbols on the package

| | |
|---|---|
|  | <p>PACKAGING MATERIAL: "KEEP DRY"</p> |
|  | <p>PACKAGING MATERIAL: "FRAGILE!"</p> |
|  | <p>PACKAGING MATERIAL: "THIS SIDE UP"</p> |
|  | <p>TEMPERATURE LIMITATION</p> |
|  | <p>TRANSPORTATION MARKING: „RELATIVE AIR HUMIDITY“.</p> |
|  | <p>TRANSPORTATION MARKING: "AIR PRESSURE".</p> |
|  | <p>RECYCLING SYMBOLS</p> |

1.2 Symbols on the birthing bed

| | |
|---|--|
|  | <p>EU LEGISLATION COMPLIANT PRODUCT</p> |
|  | <p>UK CONFORMITY ASSESSED (UKCA) MARKING (PRODUCT NORMATIVELY HARMONIZED FOR GREAT BRITAIN ECONOMIC AREA)</p> |
|  | <p>AUTHORIZED REPRESENTATIVE IN GREAT BRITAIN</p> |
|  | <p>AUTHORIZED REPRESENTATIVE IN SWITZERLAND</p> |
|  | <p>SERIAL NUMBER</p> |
|  | <p>TYPE NUMBER EXPLANATION</p> |
|  | <p>MEDICAL DEVICE (COMPATIBLE WITH MEDICAL DEVICE REGULATION)</p> |
|  | <p>UNIQUE DEVICE IDENTIFIER</p> |
|  | <p>EAC MARKING</p> |
| <p>INT x/y</p> | <p>MARKING OF INTERMITTENT OPERATION, I.E. IF THE PRODUCT HAS BEEN CONTINUOUSLY OPERATED FOR TIME PERIOD "X", THEN IT MUST REST IDLE FOR TIME PERIOD "Y" FOR EXAMPLE, INT 10 / 20 MEANS THAT AFTER 10 MINUTES OF CONTINUOUS USE /POSITIONING THE PRODUCT MUST BE OUT OF USE/NOT POSITIONED FOR 20 MINUTES</p> |
| <p>IP</p> | <p>DESIGN PROTECTION AGAINST WATER INGRESS, HAZARDOUS CONTACT AND THE INGRESS OF FOREIGN OBJECTS ACCORDING TO IEC 529</p> |
|  | <p>TYPE B APPLIED PARTS</p> |

| | |
|---|--|
|  | <p>SAFE WORKING LOAD</p> |
|  | <p>MAXIMUM PATIENT WEIGHT</p> |
|  | <p>OVERALL PRODUCT WEIGHT</p> |
|  | <p>BATTERY MARKING</p> |
|  | <p>MANUFACTURER</p> |
|  | <p>DATE OF PRODUCTION</p> |
|  | <p>FOLLOW THE INSTRUCTIONS MANUAL</p> |
|  | <p>SAFETY ISOLATING TRANSFORMER</p> |
|  | <p>MEDICAL DEVICE INTERNAL USE</p> |
|  | <p>THERMAL PROTECTION OF THE TRANSFORMER</p> |
|  | <p>EQUIPOTENTIALITY</p> |
|  | <p>MARKING ACCORDING TO THE DIRECTIVE EC 2002/96/ EC (DIRECTIVE ON DISPOSAL OF OLD ELECTRIC AND ELECTRONIC APPLIANCES) SYMBOL FOR: "DO NOT DISPOSE OF THE PRODUCT INTO COMMUNAL WASTE. USE SPECIAL COLLECTION POINTS FOR OLD ELECTRONIC APPLIANCES"</p> |









| | |
|---|--|
|  | <p>CARDIOPULMONARY RESUSCITATION (CPR)</p> |
|  | <p>SAFE WORKING LOAD OF FOOT SECTION</p> |
|  | <p>WARNING: NO SITTING ON LEG REST SAFE WORKING LOAD OF LEG REST</p> |
|  | <p>PULL THE LOCKING LEVER AND REMOVE THE HEADBOARD FROM THE BED.</p> |
|  | <p>WARNING: CAUTION</p> |
|  | <p>WARNING: RISK OF LEG INJURIES</p> |
|  | <p>WARNING: TRIPPING HAZARD</p> |
|  | <p>WARNING: DO NOT PLACE OBJECTS ON THIS AREA</p> |
|  | <p>DESIGNATION OF BIRTHING BED FOR ADULT</p> |
|  | <p>USB CELL-PHONE RECHARGER</p> |
|  | <p>CAUTION OR WARNING: THE POWER CABLE SHALL ALWAYS BE CLAMPED ON THE SELECTED PLACE OF THE BED USING A PLASTIC HOOK AS IS RECOMMENDED ON PICTURE! FOLLOW THE INSTRUCTIONS MANUAL!</p> |





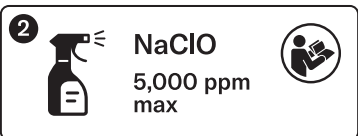

1.3 Symbols on the leatherette upholstery

| | |
|---|---|
|  | <p>THE UPHOLSTERY MEETS THE REQUIREMENTS ON RESISTANCE TO IGNITION ACCORDING TO BS 7176 IN THE MEDIUM HAZARD CATEGORY.</p> <p>THE UPHOLSTERY MEETS THE REQUIREMENTS OF BS EN 1021-1, BS EN 1021-2, BS 5852 – RESISTANCE TO IGNITION SOURCES 5</p> |
|---|---|

1.4 Symbols on the DUOCOAT mattress set













| | |
|---|--|
|  | <p>READ THE INSTRUCTIONS BEFORE USE</p> |
|  | <p>MANUAL WASHING, MANUAL MAINTENANCE</p> |
|  | <p>WASHING IN AN INDUSTRIAL WASHING MACHINE</p> |
|  | <p>WIPE WITH SOFT CLOTH WITH UNIVERSAL CLEANING SAPONATE SOLUTION</p> |
|  | <p>DISINFECT WITH SOLUTION CONTAINING <5,000 ppm SODIUM HYPOCHLORITE (SEE INSTRUCTIONS FOR USE)</p> |
|  | <p>RINSE WITH WATER</p> |
|  | <p>DO NOT USE DISINFECTANTS CONTAINING PHENOL</p> |
|  | <p>WASH INSTRUCTIONS LABEL</p> |

| | |
|--|---|
|  | <p>REFERENCE NUMBER (PRODUCT TYPE DEPENDING ON THE CONFIGURATION)</p> |
|  | <p>DATE OF MANUFACTURE</p> |
|  | <p>MANUFACTURER</p> |
|  | <p>BATCH NUMBER</p> |
|  | <p>THE UPHOLSTERY MEETS THE REQUIREMENTS ON RESISTANCE TO IGNITION ACCORDING TO BS 7176 IN THE MEDIUM HAZARD CATEGORY.</p> <p>THE UPHOLSTERY MEETS THE REQUIREMENTS OF BS EN 1021-1, BS EN 1021-2, BS 5852 – RESISTANCE TO IGNITION SOURCES 5</p> |

1.5 Symbols on the terry cloth sheet

| | |
|---|--|
|  | <p>TERRY CLOTH SHEET THE PRODUCT MUST NOT BE IRONED</p> |
|  | <p>TERRY CLOTH SHEET DO NOT DRY CLEAN</p> |
|  | <p>TERRY CLOTH SHEET MAXIMUM TEMPERATURE OF 60°C NORMAL SETTING</p> |
|  | <p>TERRY CLOTH SHEET DO NOT BLEACH</p> |
|  | <p>TERRY CLOTH SHEET MAY BE TUMBLE DRIED NORMAL TEMPERATURE, MAX. 80° C</p> |

1.6 Production label with UDI

| | | |
|---|---|---|
| <p>1</p>  <p>BORCAD MEDICAL</p> <p>BORCAD Medical a.s. Fryčovice 673, 739 45 Czech Republic www.borcadmedical.com Made in Czech Republic</p> | <p>2</p> <p>AVE2</p> <p>REF PPB-A A 30</p> <p>SN PPB1869</p> <p>MODEL: 4BCPPB-3AL00BC</p>  | <p>3</p> <p>2020-03-19</p> <p> = 240 kg</p> <p> = 255 kg</p> <p> = 245 kg</p> |
| <p>4</p> <p>UDI</p> <p>(01)8596307001168 (11)200319 (21)PPB1869</p> | <p>6</p>  <p>7</p> <p>V: 220-240V, 50/60Hz P: max. 570VA int. on/off: max 2/18 min IP X4 Class:I</p> | <p>8</p> <p>9</p> <p> </p> <p> </p> <p> </p> |

- | | |
|---|---|
| <p>1. Address of Manufacturer</p> <p>2. Type of product, serial number</p> <p>3. Manufacturing Date (Year-Month-Day)</p> <p>4. DI (Device Identifier) / GTIN (Global Trade Item Number)</p> <p>5. PI (Product Identifier)</p> | <p>6. 2D Bar Code (GS1 DataMatrix) DI+PI=UDI</p> <p>7. Electrical Specification</p> <p>8. 1D Bar code GS1-128 (Serial number)</p> <p>9. Symbols</p> |
|---|---|



Please address any potential queries to the authorized representative or directly to the Manufacturer BORCAD Medical a.s.

1.7 Acoustic signalisation

| SOUND | MEANING |
|---|--|
| One short acoustic signal when pressing a button | Key lock activated |
| Intermittent acoustic signal when pressing the Trendelenburg button | The underfoot part is neither in the 'parked' nor in the 'active' position |
| Intermittent acoustic signal when pressing the positioning button | The battery charge is lower than 1/3 of its capacity |
| One short acoustic signal when pressing the positioning button | Motor current protection activated. In order to move the bed into the requested position, it is possible to press once again the positioning button (a new attempt to adjust positioning will occur) |
| Intermittent acoustic signal even without pressing any button | Failure of the controller |
| 2x short acoustic signals when the Trendelenburg key is pressed | Position switch fault in the column. Positioning into Trendelenburg will run in emergency mode |

1.8 Abbreviations

| ABBREVIATION | MEANING |
|--------------|---|
| LED | Light emitting diodes |
| VA | Power intake unit |
| IT | Information technology |
| PC | Personal computer |
| dB | Sound intensity unit |
| hPa | Pressure unit |
| Hz | Frequency unit in the SI system |
| EMC | Electromagnetic compatibility |
| VF | High frequency |
| ME | Medical equipment |
| CISPR | International Special Committee on Radio Interference |
| SWL | Working load limit |

2 Un-packing manual

Inspection of the consignment after delivery

Do not unpack and/or accept the consignment if the package has any visual damage! If so, issue a complaint.

Personal qualification

The persons authorised for installation and putting into operation of the product, i.e. those trained by BORCAD Medical a.s.

Personnel required for unpacking and installation

Minimum two persons.

Anticipated time

Anticipated time of unpacking is 30 minutes, anticipated time of installation is 30 minutes.

Necessary tools and materials

Philips screwdriver, scissors / knife, 2x polystyrene tracks, included in the packaging.

Required working space

When unpacking, overall bed dimensions should be considered. Recycle used packaging materials. We recommend unpacking and installation be made in the goods receiving department. For unpacking operations, observe minimum 0.8m on the sides of the pallet and minimum 2.6m in front of the pallet (i.e. minimum space for unpacking 2.8 x 5.2m).

SEQUENCE OF INSTRUCTIONS



Step 1

- Cut the pockets with the user guide to the bed open carefully and take them out. Then remove the box



Step 2

- Cut the plastic bag open carefully; ideally around the bottom edge of the pallet and remove the polythene from the chair including the bottom of the box



Step 3

- Cut the foil which holds the power supply cable carefully; plug the cable in
- Then cut the band around the box containing the bed equipment and remove the bar (if contained in the package). It is recommended to put the back of the bed in an upright position (60°) in order to access the box easily.
- Take out all the equipment from the box item-by-item. Bowl if included in the packaging



Step 4

- Remove the other container from the pallet, so that the upper part is free

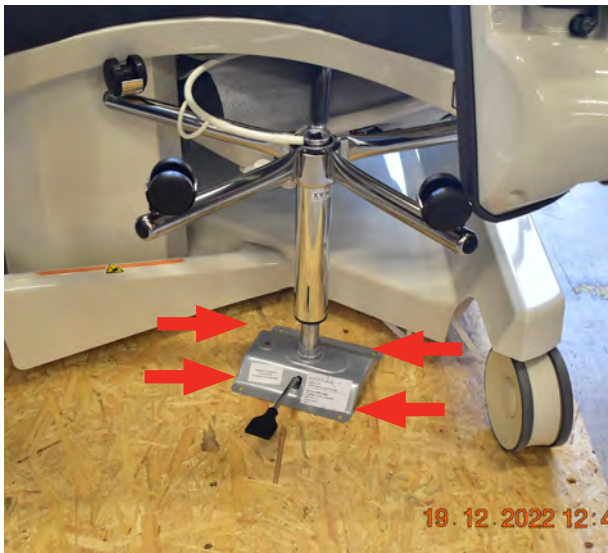

Step 5

- Unscrew the medical chair (if it is included in the package). It is recommended to put the bed to a higher position.



Step 6

- Cut and pull out the tape, loosen the underfoot part.

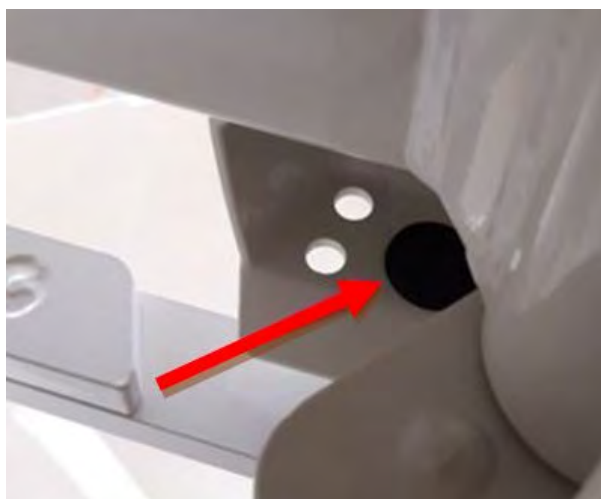

Step 7

- Remove plastic plug from the locking element



Step 8

- Remove the rest of the packaging material off the bed

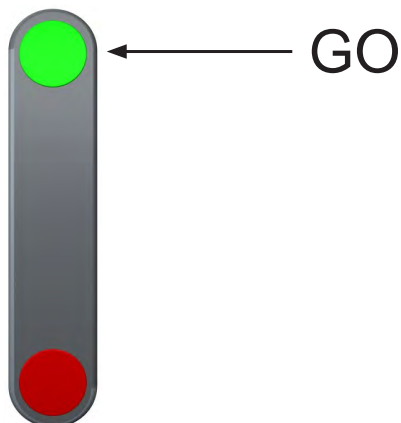

Step 9

- Make sure that all wheels are facing forward alongside the longer part of the pallet and lock the wheels to move in a straight line

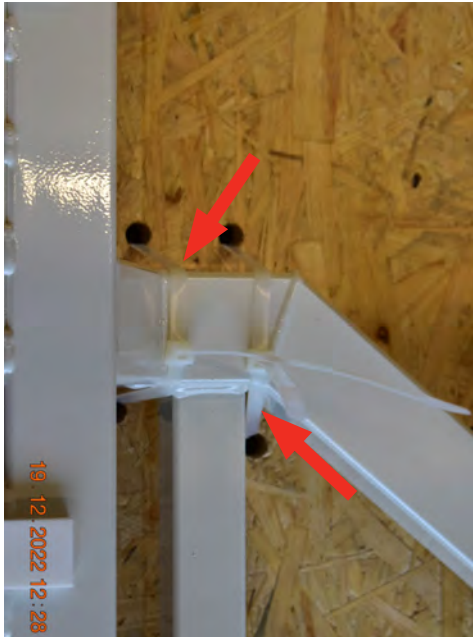

Step 10

- Cut all plastic tapes that hold the basic frame onto the pallet



Step 11

- Put two polystyrene ramps to the edge of the pallet



Step 12

- Carefully push the bed so that it gets from the anchoring wedges to the pallet and then move it down using the ramps

BACK-UP BATTERY CONNECTING

With regard to the possibility of unwanted switching on of AVE2 upon packaging, transport and unpacking, the battery is normally disconnected from the equipment. The following pictures show how to connect the battery

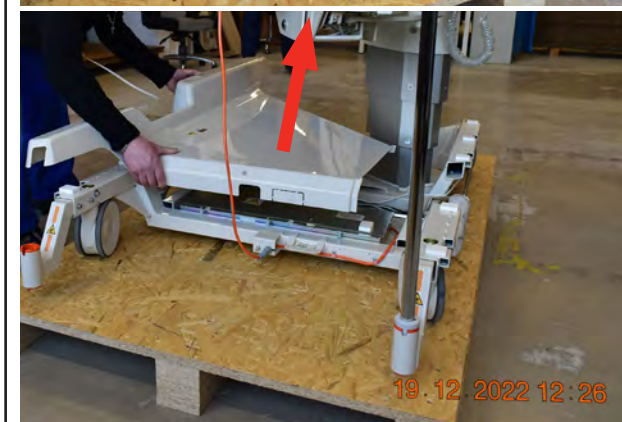

Step 1

- Remove the undercarriage cover



Step 2

- The cover is removed by screwing out three wrenches

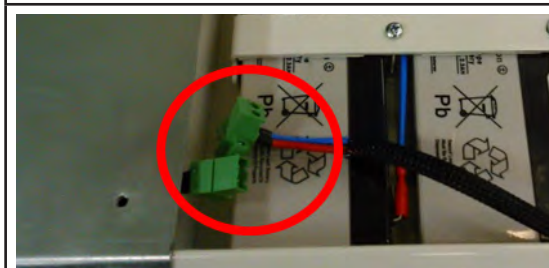

Step 3

- Insert the connector in the back-up battery
- Put the protective cover in place and screw the Allen wrenches back on

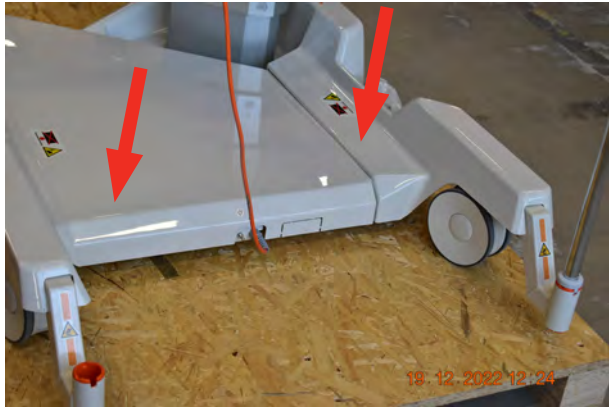

Step 4

- Put the undercarriage cover back in place

3 General safety

**WARNING!**

Birth Bed is not primarily intended for newborns. For this case there is a special cot which comes as a separate medical device. It is assumed that the position of the baby during breast-feeding is under the constant control of the mother and thus any uncontrollable movement of a newborn on the bed is improbable. After breastfeeding the newborn baby is moved into the cot intended for this purpose. The caregivers are informed about potential risks in the instruction manual

**WARNING!**

Do not operate the bed in rooms with inflammable gases/vapours. Danger of injury/damage of the equipment.

**WARNING!**

Use only ventilation or nasal-type oxygen supply units. Do not use the bed in oxygen tents (risk of injury or damage of the equipment).

**WARNING!**

Any serious incident that has occurred in relation to the device should be reported to the manufacturer and the competent authority of the Member State in which the user and/or patient is established!

**WARNING!**

Only authorised and trained person using the tool is allowed to change fuses and power supplies!

**WARNING!**

This medical device is not intended for oxygen enriched environment!

**WARNING!**

This medical device is not intended for use with flammable substances!

**WARNING!**

This medical device is not portable medical electrical equipment!

**WARNING!**

Make sure the duty cycle (2 min ON/18 min OFF) is not exceeded during bed positioning!

**WARNING!**

Patient is allowed to use selected control elements only if hospital personnel had assessed that the patient's physical and psychological state is in accordance with use of them and only if the hospital personnel had trained the patient in accordance with the instructions for use!

Additional Instructions for correct use:

- ▶ **Leave the bed in the low position when the patient is unattended. This can reduce the possibility of patient falls and the severity of any resultant injuries.**
- ▶ Make sure to fix and set the accessories properly (tightening of handles etc.)
- ▶ Do not dismantle or execute unqualified repairs of motors, control unit, etc.
- ▶ The birthing bedAVE2 must not be used in medical facilities with fire or explosion risks caused by air or in combination with nitrous oxide and anesthetics or cleaning agents.
- ▶ Construction modifications reserved!
- ▶ The bed must be equipotentially connected with other medical devices to prevent fire in combination with flammable substances and anesthetics during minor surgical procedures using high-frequency (HF) instruments.
- ▶ Never use other than original accessories. All original accessories are marked with an original label containing the name and brand of the manufacturer, designation of the product and a code including further information (serial number or batch ID and date of manufacture).
- ▶ **Modifications to the birthing bed are forbidden.**
- ▶ **The birthing bed is intended only for use by medical professionals and for woman in labor (locked siderails and headboard as handles or functions buttons on inner side of siderails for her higher comfort).**
- ▶ **Bed maintenance cannot be performed while ME equipment is in use!**

3.1 Mechanical safety



WARNING!

No objects that may collide with the bed (furniture, stands etc.) may be located near it (20 cm minimum). Special caution must be taken when operating moving parts of the bed. Damage of the bed or patient injury may occur as result of the bed parts colliding with other objects!



WARNING!

The bed is not designed for mothers over 240 kg (527 lb).



WARNING!

Before the mother in labor accesses the bed, the castor brakes must be engaged. Accessing the bed only from side of seat section



Additional Instructions for correct use:

- ▶ No objects that may collide with the bed (furniture, stands etc.) may be located near it
- ▶ Never enter the space under motor operated parts of bed (back, seat and leg rests)
- ▶ Before undertaking any resetting of the birthing bed check if no one is within reach of the moving parts
- ▶ Before any resetting, check for kinked and/or tangled power cables
- ▶ After setting the bed in place, all brakes must be engaged so as to prevent unwanted movement of the bed, e.g. during patient's occupancy. When setting the bed all four castors have to be in contact with the floor and the brakes engaged

4 Overview of basic parts



- | | |
|--|---|
| 1. Back section | 10. Side control panel |
| 2. Seat section | 11. Control light for power supply |
| 3. Foot section | 12. Holder for infusion stand |
| 4. Castor, directional 1x | 13. Hand grips |
| 5. Castor with brake 3x | 14. Side rails with electric control pane |
| 6. Plastic covers of chassis | 15. Central brake |
| 7. Leg rests with leg straps | 16. Manual CPR functions |
| 8. Back handle for transportation | 17. Leg rest tray |
| 9. Euroloth along seat section (accessories) | 18. Detachable bed-head (accessories) |

4.1 Overview of basic versions

| | |
|---------------|------------|
| PPB-AX | Basic type |
|---------------|------------|

4.2 Overview of colour versions

Substituted by the letter "X".

| | |
|----------|--------|
| A | Purple |
| B | Blue |
| F | Green |
| M | Yellow |
| P | Orange |

4.3 Safety

Standards and specifications

Referenced standards are listed in the Declaration of Conformity.

The manufacturer has implemented certified quality management system in accordance with the following standards:

- ▶ ISO 9001
- ▶ ISO 14001
- ▶ ISO 13485

Fire Extinguishing Information



WARNING!

Danger of frostbite by contact of CO2 with human skin!

Do not use halotron extinguisher in closed rooms without ventilation – danger to your health!

The medical product is categorised as energised electric installation, hence, fire can be extinguished by the following types of extinguishers

| USE |
|-----------------------|
| Powder extinguisher |
| CO2 extinguisher |
| Halotron extinguisher |

| DO NOT USE! |
|--------------------|
| Foam extinguisher |
| Water extinguisher |

5 Function



WARNING!

The essential functions are lying, sitting and supporting the woman in labour. Additionally, it is the CPR position.

Delivery bed is used by mothers before and during delivery and after delivery. A bed equipped with adequate accessories offers birth mothers the opportunity to achieve their optimum position for birth. Positioning and handling the bed is not an obstacle in providing healthcare. Handling the foot section, especially by folding it (fast way to store it under the seat/back section) at the end of the second stage of delivery creates enough space to perform obstetrical and vaginal surgeries. It is also useful for practical training of medical students and midwives. It also enables positioning on the side until the foetus is removed (supine syndrome prevention), as well as the use of other medical devices (resulting in ME system) for continuous control of reduced venous return, blood pressure, routine ECG monitoring, pulse oximeter, NIBP, and capnometry. During procedures it is possible to use approved surgical devices (HF) for making incisions or coagulation. If it is necessary to perform cardiopulmonary resuscitation, it can be performed in this delivery bed including the use of the defibrillator. Delivery bed is also equipped with a Trendelenburg position. After the delivery and the transfer of a birth mother it is necessary to wash and disinfect all the easily removable parts and light upholstery together with plastic parts and covers again

5.1 Interaction

When using the delivery bed as part of the medical system, certain elements (medical devices) may interact. Before this application it is necessary to follow recommendations provided in the user manual of the delivery bed AVE2.

5.2 General instructions

The birthing bed may only be operated where the conditions of valid standards for el. distribution in medical facilities are met. According to the Act on Means of Medical Instrumentation the product may only be operated by persons with adequate qualification.

5.3 Application environment 5

Outpatient (ambulatory) care, which is provided in a hospital or other medical facility, under medical supervision and me equipment, is provided for the need of persons with illness, injury or disability for treatment, diagnosis or monitoring.

6 Intended use

Birthing bed is designed to be used by mothers-to-be for vaginal delivery. The birthing bed is designed to enable different birthing positions in all delivery birthing stages including postpartum period.

6.1 User population

- ▶ Pregnant women during ambulant and stationary pregnancy check-ups and/or in all labor stages and her companions.
- ▶ Caregivers and hospital staff (midwives, labor and delivery nurses, doctors, and technical personnel, transport personnel, cleaning personnel, interns and birth professional students)
- ▶ Maintenance personnel

6.2 Contraindications

- ▶ Contraindication is the use of the birthing bed for elective (planned) Caesarean sections. The birthing bed cannot be used to leave the newborn on unattended.
- ▶ The birthing bed cannot be used as a crib for the newborn.
- ▶ The birthing bed is not intended for use as a general hospital bed.

6.3 Operator

- ▶ Caregiver
- ▶ Patient (based on individual patient status assessment by caregiver the patient can utilize dedicated device functions)

7 Technical Specification

7.1 Identification of Applied Parts

The attached parts on the product are classified as Type B - they provide basic protection of the patient and comply with the applicable requirements of ČSN EN 60601-1 ed. 2:2007, by which they meet the requirements on classification of Type B attached parts.



7.2 Technical parameters

| | |
|---|---|
| Total length of the lying area (including the foot section) | 2 122 mm (83.54 inch) |
| Minimum length in the default setting (without the foot section) | 1 570 mm (61.81inch) |
| Full width with the side rails in active position | 980 mm (38.58 inch) |
| Full width with the side rails in parked position | 960 mm (37.79 inch) |
| Maximum height of the seat section (Trendelenburg 40°) | 1143 mm (45 inch) |
| Upholstery width (maximum) | 890 mm (35.04 inch) |
| Upholstery length (maximum) | 2 050 mm (80.71 inch) |
| Castor size | 150 mm (5.91 inch) |
| Height of the supporting area including upholstery (seat section): | |
| Minimum | 600 mm + 20 mm (23.62 inch + 0.78 inch) |
| Maximum | 1 050 mm + 20 mm (41.34 inch + 0.78 inch) |
| Vertical lift | 450 mm (17.72 inch) |
| Vertical speed up (with max patient load) | 11.25 mm/s (0.44 inch/s) |
| Vertical speed down (with max patient load) | 20.45 mm/s (0.81 inch/s) |
| Upholstery thickness: | |
| Foot section | 65 mm (2.56 inch) |
| Back section | 100/130 mm (3.93/5.11 inch) |
| Seat section | 100/130 mm (3.93/5.11 inch) |
| Adjustment angles: | |
| Back section positioning angle | -10°/+70° |
| Seat section positioning angle | 0°/+18.5° |
| Trendelenburg position | -10° |
| Leg rests vertical adjustment angle | 0°/+143° |
| Leg rests horizontal adjustment angle | +60° |
| Foot section adjustment angle | 0° - 22° |
| Stickers, labels material | polymeric PVC foil |
| Maximum patient load | 240 kg (529 lb) |
| Safe working load | 255 kg (562 lb) |
| Overall product weight without accessories | 245 kg (540 lb) |
| Overall weight of the upper part of the birthing bed including accessories | 140 kg (308 lb) |
| Overall weight of the lower part of the birthing bed including accessories | 96 kg (211 lb) |

| | |
|---|-------------------------------|
| Permitted back section load (125 mm from the edge) | 150 kg (330 lb) |
| Permitted foot section load (125 mm from the edge) | 150 kg (330 lb) |
| Permitted leg rest load | 70 kg (154 lb) |
| Permitted load of side rail | 75 kg (165 lb) vertical press |
| Permitted load of supporting bar | 70 kg (154 lb) |
| Weight of mattress (back and seat section 100/130mm, 2.56-5.11 inch) | 8.6 - 9.6 kg (19-21 lb) |
| Weight of mattress (foot section) | 1.2 kg (2.64 lb) |
| Weight of mattress (pair of leg rest) | 2.6 kg (5.73 lb) |
| Noise level | Less than 65 dB (A) |

7.3 Electrical parameters

| | |
|---|--|
| Batteries – back-up | 24V/2,3 Ah |
| Voltage – input | 220 - 240 VAC |
| Voltage – input | 110 - 120 VAC |
| Voltage – input | 100 VAC |
| Voltage – input | 127 VAC |
| Frequency | 50/60 Hz |
| Nominal value of the fuse in the control unit (220-240V) | T 3,15 AL, 250V |
| Nominal value of the fuse in the control unit (100 V) | T 6,3 AL, 250V |
| Nominal value of the fuse in the control unit(110-120V) | T 6,3 AL, 250V |
| Nominal value of the fuse in the control unit (127V) | T 6,3 AL, 250V |
| Maximum input | 570 VA |
| Motor voltage | 24 V |
| Ingress protection of the birthing bed | IPX4 |
| Device class | I. |
| Classification of applied parts | B |
| All possibilities of voltage – input | 100 VAC 50/60 Hz 110-120 VAC 50/60 Hz 127 VAC 50/60 Hz 220-240 VAC 50/60 Hz |

Functional description of motors:

The birthing bed is fitted with electrical linear motors for moving the back section, seat section and for bed height adjustment. These motors require no maintenance.

7.4 Technical specifications of the DUOCOAT mattress set

All technical data are nominal data and are subject to design and manufacturing tolerances.

| | AVE2 DUOCOAT COMFORT | AVE2 DUOCOAT PREMIUM |
|---|---|---|
| Foam material | polyurethane foam | polyurethane and memory foam |
| Cover material Base Coating | 100% polyester 100% polyurethane | 100% polyester 100% polyurethane |
| Water column height | >200 cm | >200 cm |
| Mattress shape | Shape of the back and seat section of the bed | Shape of the back and seat section of the bed |
| Cover | waterproof | waterproof |
| Mattress type | single sided | single sided |
| Load capacity, weight and height of the mattress | The load capacity of the mattress is 240 kg and the height 130 mm | The load capacity of the mattress is 240 kg and the height 130 mm |
| Risk of pressure ulcers depending on the patient's condition | Up to the second degree of the risk of pressure ulcers | Up to the second degree of the risk of pressure ulcers |
| Kind of mattress | With washable top cover | With washable top cover |
| Foam warranty | 2 years | 2 years |
| Outer cover warranty | 1 year | 1 year |

7.5 Transport instruction, Storage instruction

| | | | |
|-------------------------------|--------------|-------------------------------|---------------------|
| Operation | 10°C – 40°C | 30% – 75% | 795 hPa – 1 060 hPa |
| Storage and transport: | -10°C – 50°C | 20% – 90% (non-condensing) | 795 hPa – 1 060 hPa |

7.6 Electromagnetic compatibility

Bed is intended for hospitals except for near active HF surgical equipment and the RF shielded room of a medical system for magnetic resonance imaging, where the intensity of EM disturbances is high.

Bed has defined no essential performance

List of used cables:

- ▶ Mains cable, maximum length 6 m



WARNING!

It is recommended to avoid the use of this device next to or in block with other device, because it could lead to improper operation. If such use is needed, this device and the other equipment should be under surveillance to verify proper operation.



WARNING!

Use of the accessories, converters and other cables, than specified and provided by manufacturer of this bed could lead to increase of electromagnetic emission or lower the electromagnetic immunity of this bed and lead to improper operation.



WARNING!

Mobile RF communication device (including end use devices like antenna cables and external antenna) should not be used closer than 30 cm (12 inches) from any part of this bed AVE2, including cables specified by manufacturer. Otherwise this could lead to deterioration of functionality of this bed.



WARNING!

Do not overload the bed (SWL), respect the duty cycle (INT.) Maintenance in order to maintain the basic safety with regard to electromagnetic disturbances for the expected service life.

7.6.1 Manufacturer instructions – electromagnetic emissions

| EMISSION TEST | COMPLIANCE |
|---|-----------------|
| RF emissions CISPR 11 | Group 1 |
| RF emissions CISPR 11 | Class B |
| Harmonic emissions IEC 61000-3-2 | Class A |
| Voltage fluctuations / flicker emissions IEC 61000-3-3 | Complies |

7.6.2 Manufacturer instructions – electromagnetic susceptibility

| IMMUNITY TESTS | COMPLIANCE LEVEL |
|---|---|
| Electrostatic discharge (ESD) IEC 61000-4-2 | ± 8 kV for contact discharge ± 15 kV for contact discharge |
| Radiated RF IEC 61000-4-3 Proximity fields from RF wireless communications equipment IEC 61000-4-3 | 3 V/m 80 MHz – 2,7 GHz 80 % AM at 1 kHz <i>see TABLE 1 on page 36</i> |
| Fast electrical transients / burst IEC 61000-4-4 | ±2 kV for power line repetition frequency 100 kHz |
| Surge IEC 61000-4-5 | ± 1 kV Line-to-line ± 2 kV Line-to-ground |
| Conducted RF IEC 61000-4-6 | 3 V (0,15 MHz – 80 MHz) 6 V in ISM bands between 0,15 MHz and 80 MHz 80 % AM at 1 kHz |
| Power frequency (50/60 Hz) magnetic field IEC 61000-4-8 | 30 A/m |
| Voltage dips, short interruptions on power supply input lines IEC 61000-4-11 | 0 % U_T ; 0,5 cycle At 0°, 45°, 90°, 135°, 180°, 225°, 270° a 315° 0 % U_T ; 1 cycle and 70 % U_T ; 25/30 cycle Single phase: at 0° 0 % U_T ; 250/300 cycle |

TABLE 1 – IMMUNITY to RF wireless communications equipment

| TEST FREQUENCY (MHz) | BAND (MHz) | SERVICE | MODULATION | IMMUNITY TEST LEVEL (V/m) |
|-------------------------|---------------|---|------------------------------------|---------------------------|
| 385 | 380 - 390 | TETRA 400 | Pulse modulation 18 Hz | 27 |
| 450 | 430 - 470 | GMRS 460, FRS 460 | FM ± 5 kHz deviation 1 kHz sine | 28 |
| 710 745 780 | 704 - 787 | LTE band 13, 17 | Pulse modulation 217 Hz | 9 |
| 810 870 930 | 800 - 960 | GSM 800/900, TETRA 800, iDEN 820, CDMA 850, LTE band 5 | Pulse modulation 18 Hz | 28 |
| 1 720 1 845 1 970 | 1 700 - 1 990 | GSM 1800; CDMA 1900; GSM 1900; DECT; LTE band 1, 3, 4, 25; UMTS | Pulse modulation 217 Hz | 28 |
| 2 450 | 2 400 - 2 570 | Bluetooth, WLAN, 802.11 b/g/n, RFID 2450, LTE band 7 | Pulse modulation 217 Hz | 28 |
| 5 240 5 500 5 785 | 5 100 - 5 800 | WLAN 802.11 a/n | Pulse modulation 217 Hz | 9 |

NOTE There are applied no deviations to requirements of IEC 60601-1-2 ed. 4

NOTE There are no known other measures for keeping the basic safety based on EMC phenomena

8 Setting the product

- ▶ Check all delivered items after unpacking
- ▶ Install the equipment and accessories
- ▶ Install front panel (in case of beds with dismantable front panels)
- ▶ Always install the bed on even floors
- ▶ When installing the bed, avoid collision with power supply cable or excessive tensioning of the cable
- ▶ Check correct plugging in
- ▶ Avoid lose extension cables/ power socket bars lying on the floor
- ▶ Check all mechanical and electric protection elements are in place
- ▶ The bed has not any central switch. When disconnecting from power mains, plug off power cable
- ▶ The power cable should always be accessible
- ▶ The power cable must not be connected through an extension cord and it must not be connected to common multisolet inlets (three-way hub etc.)
- ▶ No input cable of other devices can lead over the surfaces of the bed or over the patient. When moving the bed, avoid pinching/kinking of any objects
- ▶ Pay attention to proper fixing of the approved accessories listed in the manual
- ▶ The birthing bed is installed by trained person. It can be operated in ordinary way by trained personnel only. Trained personnel must be also educated on appropriate height of infusion stand setting
- ▶ The training is provided by BORCAD Medical a.s. (manufacturer) representative or its authorized dealership

We recomend to set up the bed into the Welcome position

- ▶ Straight "horizontal" position at the lowest possible height of the bed
- ▶ The foot section and legrests is extended and set in the highest position, where it serves as a lying area
- ▶ The bed is covered with government-issue sheets / disposable drapes
- ▶ Side handles are in the active position; safety function
- ▶ The hand grips are hidden away so they do not get in the way when the mother enters the bed
- ▶ When the room is made dim in order to create a more pleasing atmosphere, the backlight of the bed is switched on
- ▶ The wheels are braked with a central brake
- ▶ The staff always briefly instruct the mother on how to use the bed (control the basic functions, the bed's adjustment) and showing the warning labels

8.1 Transport, braking

The birthing bed also allows for the transport of a patient. This is, however, subject to the following conditions:



WARNING!

The birthing bed allows for the transport of a patient by pushing forward using the handle on the back section. Before transporting the patient, disconnect and store the power supply cables and equipotential and other connections properly, to prevent their tearing off. Use the handle on the back section only to transport the bed. Do not transport the patient if the bed is set in the chair position. If you do so, you can cause injury to persons or damage to the device. Before transporting the patient, the central brake must be released



WARNING!

Before running the device ensure that the front wheels are set in the direction of travel, meaning that the front wheels are not pushed by the bed. In this situation the wheels can be damaged.



WARNING!

When transporting the patient, the locking pedal must be used to secure the front directional castor in a straight direction. Otherwise the patient has to be transported by two persons.



WARNING!

When transporting the bed within hospital premises, make sure that the patient as well as all equipment, such as cables (including the power supply cable), hoses, tubes, etc., are safely placed in the area bounded by the circumference of the bed. Otherwise you can cause injury to persons or damage to the device.



WARNING!

During transport, check the stability of the infusion stand - it can hit doors or ceiling lights. Before transporting the patient, set the stands to the lowest position. Otherwise you can cause injury to persons or damage to the device.



WARNING!

After the transport, reconnect the power supply cable and secure the bed with the central brake. Otherwise you can cause injury to persons or damage to the device.



WARNING!

Do not expose the bed to prolonged extreme effects of external environment (snow, frost, rain, etc.). It could damage the device.



WARNING!

Transport the bed in its lowest position and make sure that it is not transported over areas with lateral inclination exceeding 5°. In case of interrupting the transport (stopping the movement of the bed), always secure the bed with the central brake. Otherwise you can cause injury to persons or damage to the device.



WARNING!

The maximum threshold crossing height is 20 mm.

**WARNING!**

During transport, pay attention to the leg rests, side rails, foot section and hand grips to prevent hitting doors and other objects. Otherwise you can cause injury to persons or damage to the device.

**WARNING!**

Observe the following security hints when transporting the bed:

- ▶ When crossing transversal obstacles, lower the rest area to the lowest position.
- ▶ Avoid crossing of cables
- ▶ During transport, the power cable must be fixed with the hook
- ▶ Be sure the castors are unlocked before transport (see section related to adjustment of the castors and transport of the bed)
- ▶ Move the bed only on the floors with suitable surface.

When transporting the birthing bed (with/without the patient), the following instructions must be observed:

1. Move the rest area of the bed to horizontal position, the handles being in active (upper) position.
2. Move leg supports to horizontal position, thus constituting compact rest area together with the mattress and avoiding leg support projection outside of the circumference of the bed.
3. Disconnect power cable, equipotential and other connections, thus avoiding their pulling out.
4. Use the handrail on the back section for transport of the bed.
5. When transporting the bed by one operator, activate the direction castor, otherwise, the transport must be carried out by two operators.
6. During transport interruption, central brake must always be applied.
7. After the transport, connect the power cable and secure the bed with the central brake.

8.2 Transport



DANGEROUS ELECTRIC VOLTAGE!

Before transport, disconnect power supply cables, equipotential and other connection lines, thus avoiding their pulling out.



DANGEROUS ELECTRIC VOLTAGE!

The power cable must be fixed to the bed at the selected point using plastic hook! Never wind up the cable on the bed/its parts, e.g. side handles, front section, handrails and other items!

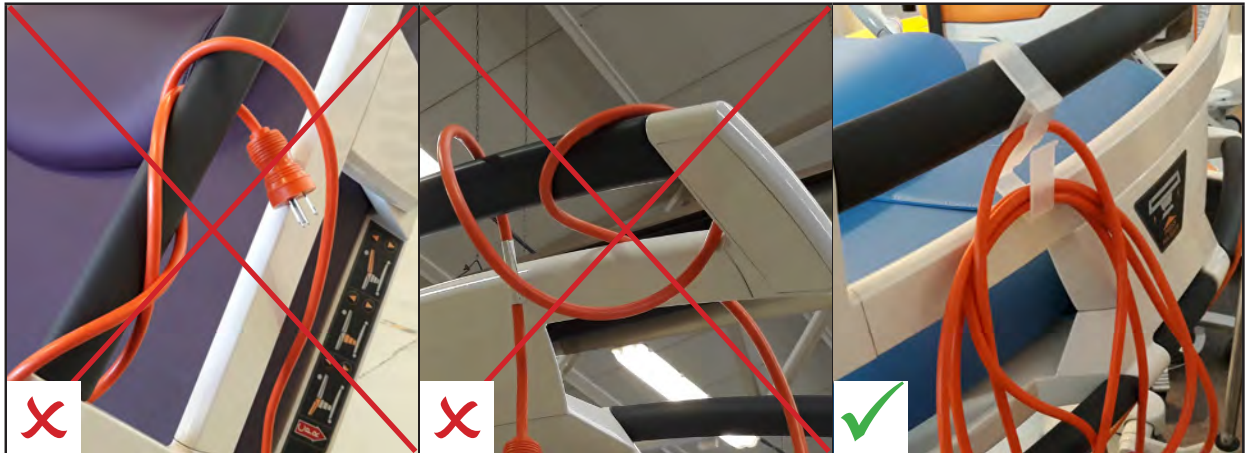

DANGEROUS ELECTRIC VOLTAGE!

In case of visible damage of the power cable, do not use the birthing bed and/or the cable! Always call technical service operator!



WARNING!

Only rear handles can be used for transporting the bed!



WARNING!

Do not transport any patient, when the bed is in "chair" position. Danger of injury to the patient or damage of the equipment!



WARNING!

When transporting the bed within the building, be sure the patient and all items, e.g. cables (incl. power cable), hose, pipe etc. are properly positioned within the circumference of the unit. Danger of injury to the patient or damage of the equipment!



WARNING!

During transport, stability of the infusion stand must be monitored. Avoid hitting the doors/ceiling lights. Before transport of the patient, always put the infusion stand to the lowest position, thus avoiding injury to the patient or damage of the equipment.



WARNING!

When the transport is complete, connect the mains cable to the mains and secure the bed with the central brake. Danger of injury to the patient or damage of the equipment!

Suitable floor:

- ▶ Floor tiles
- ▶ Hard linoleum
- ▶ Cast floor

Unsuitable floor:

- ▶ Too soft, not sealed or defective flooring
- ▶ Soft wood floor
- ▶ Soft and porous artificial stone floors
- ▶ Carpets with lining
- ▶ Soft linoleum
- ▶ When transporting the bed at a distance, check the castor control is active (main control lever)
- ▶ Release the brake before transporting the bed

The delivery bed is fitted with four castors (150 mm on default) and it may be moved in all directions. Castor functions are controlled by two double-way pedal brakes

Setting of the wheel pedal:

| | |
|----------------|--|
| STOP | Four castors locked |
| NEUTRAL | All castors free, spinning around their axle |
| GO | The left front castor is locked in straight direction, the other castors are unlocked, turning around their axes |

SYMBOLS MEANING OF ARREST CONTROL PEDALS:

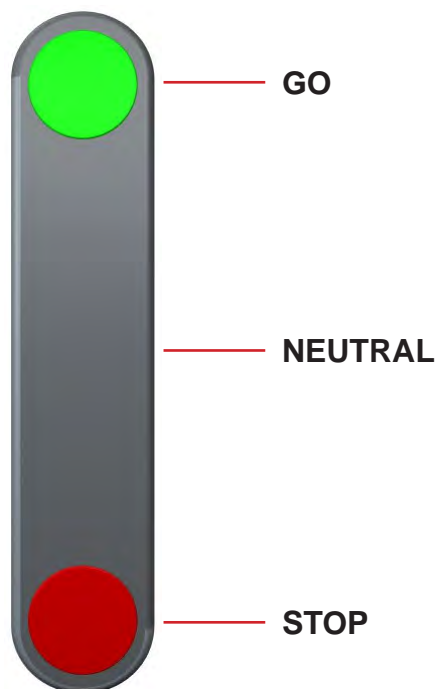

9 Operating the bed



WARNING!

The birthing bed is not designed for permanent operation – motors can only be loaded up to the values defined on the label, i.e. 2 minutes of operation followed by 18 minutes of stand by. Excess workload of the device may result in automatic stop. Under such conditions, authorized service action is needed.



WARNING!

The bed includes firmware that can be updated only by an authorised service technician. This firmware is protected against unauthorised access by mechanical housing (tool is needed to access), by seal (components with processor are sealed), by exclusive compatibility with an authorised software tool and by check of compatibility of the new firmware with the bed.

- ▶ Components of the product are not treated against fire. Hence, avoid handling near open fire. If this rule is not observed, the device may catch fire.
- ▶ When handling the product, please pay attention to the protection of a power cable against mechanical damage, especially its insulation.
- ▶ In case of fuse replacement pay attention to correct selection of a fuse type. Fuses need not be replaced by an authorized BORCAD Medical a.s. service; it can be done by a qualified electrician.
- ▶ Pay attention to free passage of hoses, cannulae, and other free parts (in case infusions are used) so as not to get these pinched in the moving parts of the product (rails or leaning parts may be the risk locations).
- ▶ When positioning the product, collision with objects may occur. Keeping safe distance from other objects is recommended in order to prevent damage and injury

9.1 Side rails



WARNING!

Always check functionality of the side rails before use



WARNING!

Upon regular service check-up it is necessary to check and adjust side rails



WARNING!

Siderails are intended to be a reminder, not a patient restraining device.



WARNING!

The siderails should always be in a full upright position and latched when a patient is unattended

The woman sitting in the chair can use the handles for increasing her sitting stability or pressing internal functional buttons to increase her sitting comfort.

Side rails are also intended for medical professionals. During closer access to woman in labor siderails can be parked away from outer side. Undetachable side rails can be used by the birth mother to fix herself and reach more stable position during birth.

9.1.1 Description of the control panel for the woman in childbirth

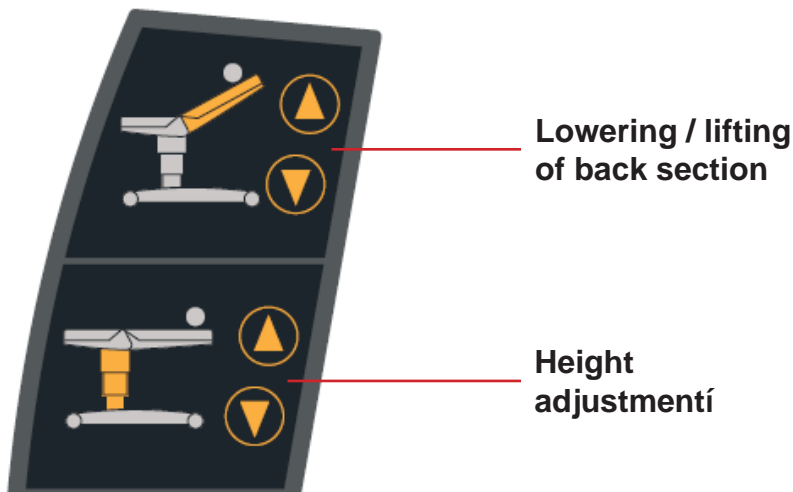

9.1.2 Adjustment of the handle in inactive position

- ▶ To initiate lowering, push the trigger in the marked direction with one hand, then lower the rail to the lowest position possible. The parking position is suitable for birth mother to get easily on the bed, eventually for better access to the patient during birth

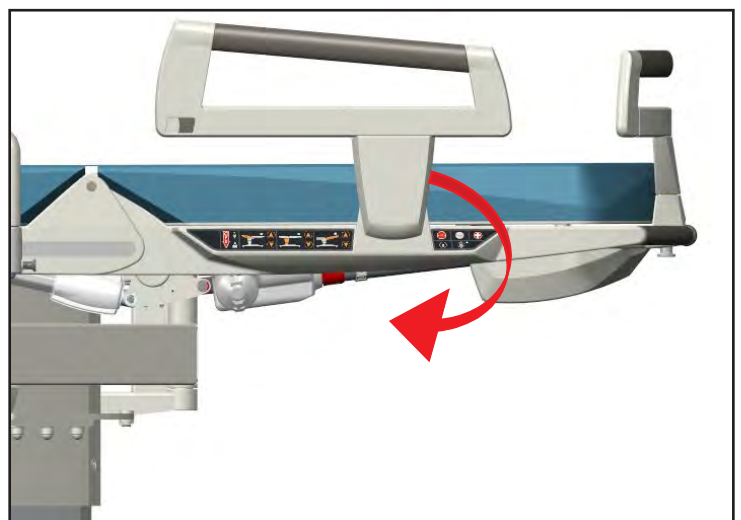
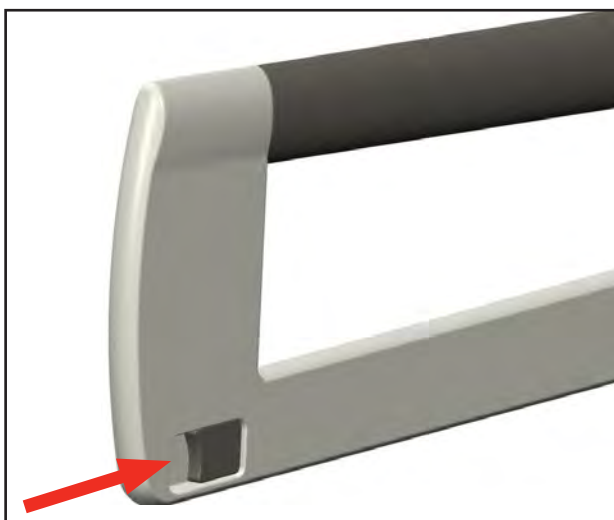

9.1.3 Adjustment of the handle in active position

- ▶ In the active position, you only need to pull the handle to the highest position. The rail locks in the active position automatically

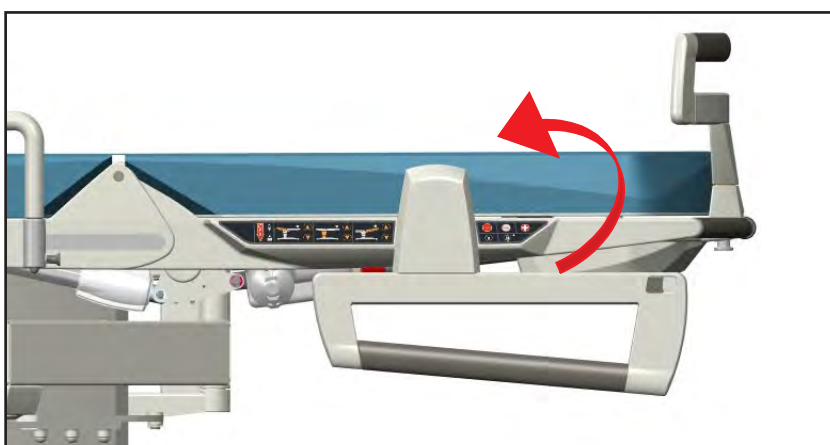

9.2 Side control panel



WARNING!

Side control panel is located on both sides of AVE2 birthing bed. The panel can be operated by trained personnel only

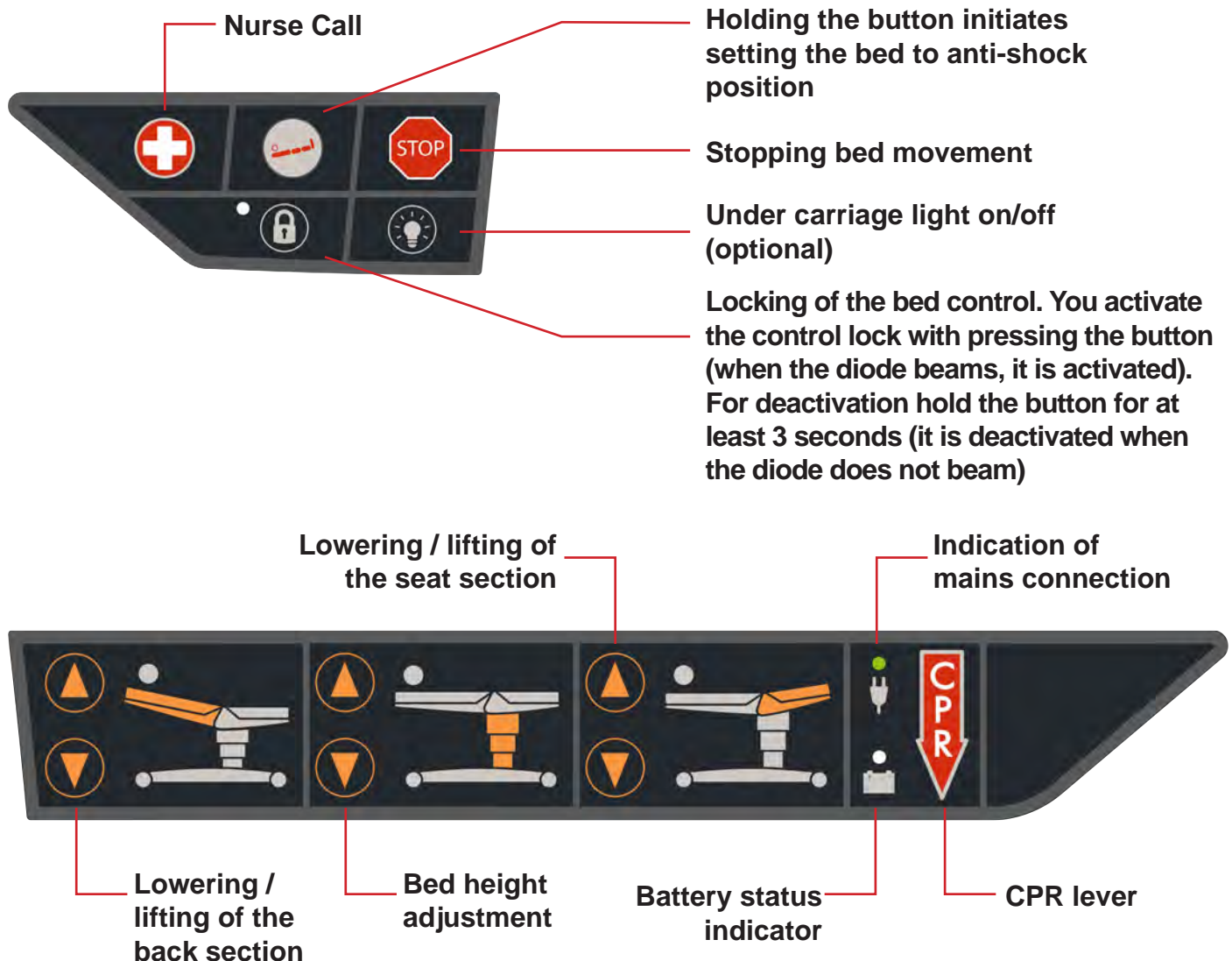
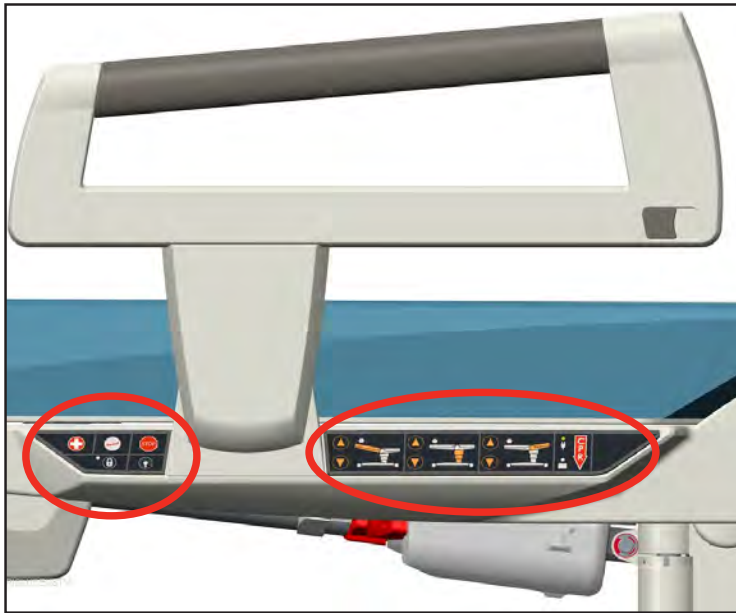

9.3 Manual setting of the CPR



WARNING!

The CPR controller is marked with red information labels on both sides of the back section. The labels are marked with CPR text



WARNING!

During movement, the back support must be loaded (e.g. with the patient's weight)

NOTE Before first use of the bed, we recommend performing the movement of the back rest of the bed multiple times using the CPR function. The CPR function may be slightly impaired if the bed has not been used for some time

IMPORTANT To start the CPR function, the patient must be on the birthing bed

IMPORTANT The CPR function is in full agreement with the requirements of valid norms

To manually position the back rest:

- ▶ Pull the red CPR lever while pushing the back rest of the bed down. Keep holding the lever.

The CPR lever is located on the back rest of the bed and it is accessible from either side. The back rest of the bed sinks depending on the weight of the patient

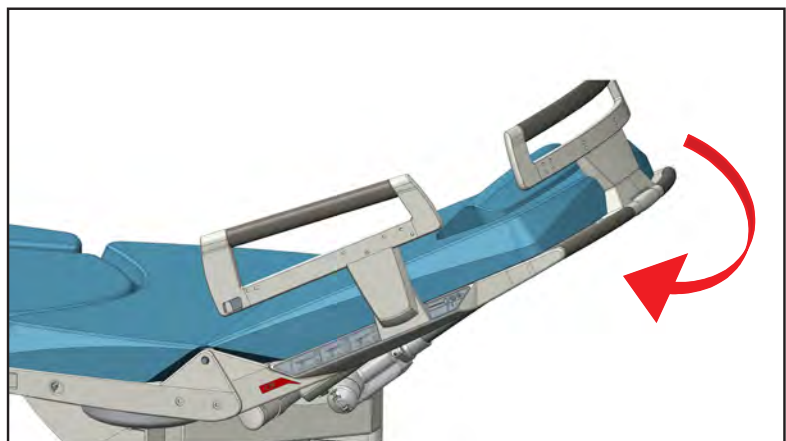
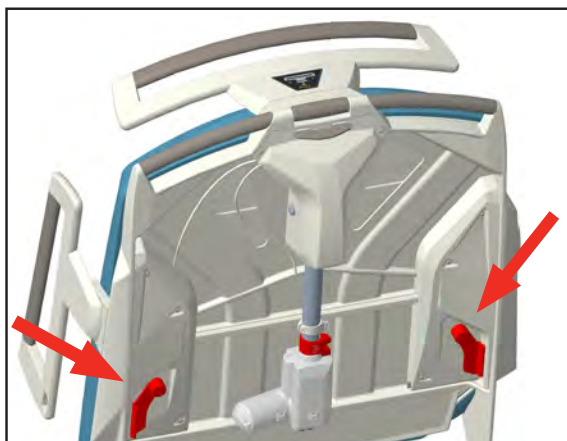

To reset the back section to its original position:

- ▶ Use motoric positioning (activates via hand control, side control panel or side rail panel)

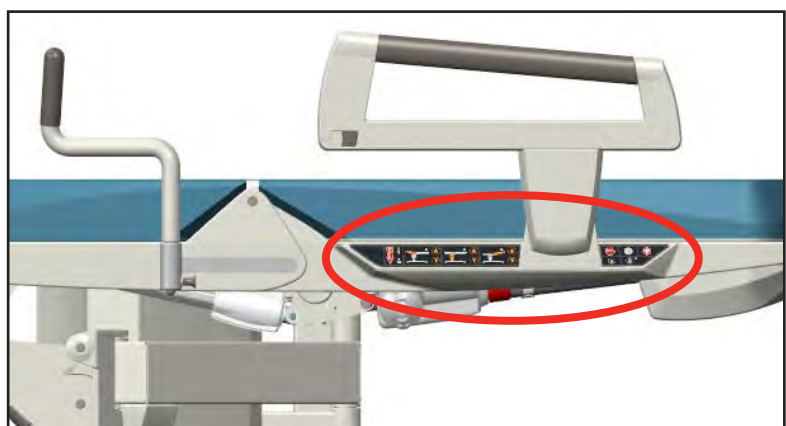

9.4 Electric setting of Trendelenburg



WARNING!

The controller is marked with orange on both sides of the back section



WARNING!

If the bed stops during the positioning movement and the control box generates a sound signal, the foot section has not been fixed properly

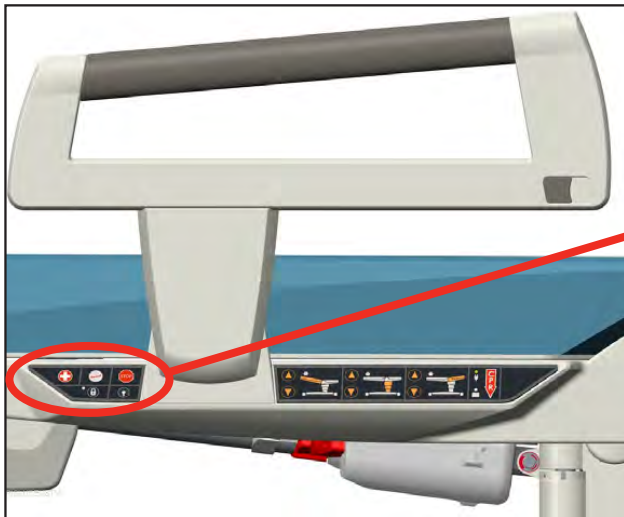

For positioning of the back section:

- ▶ Push the above-marked button and hold it until the positioning comes to an end

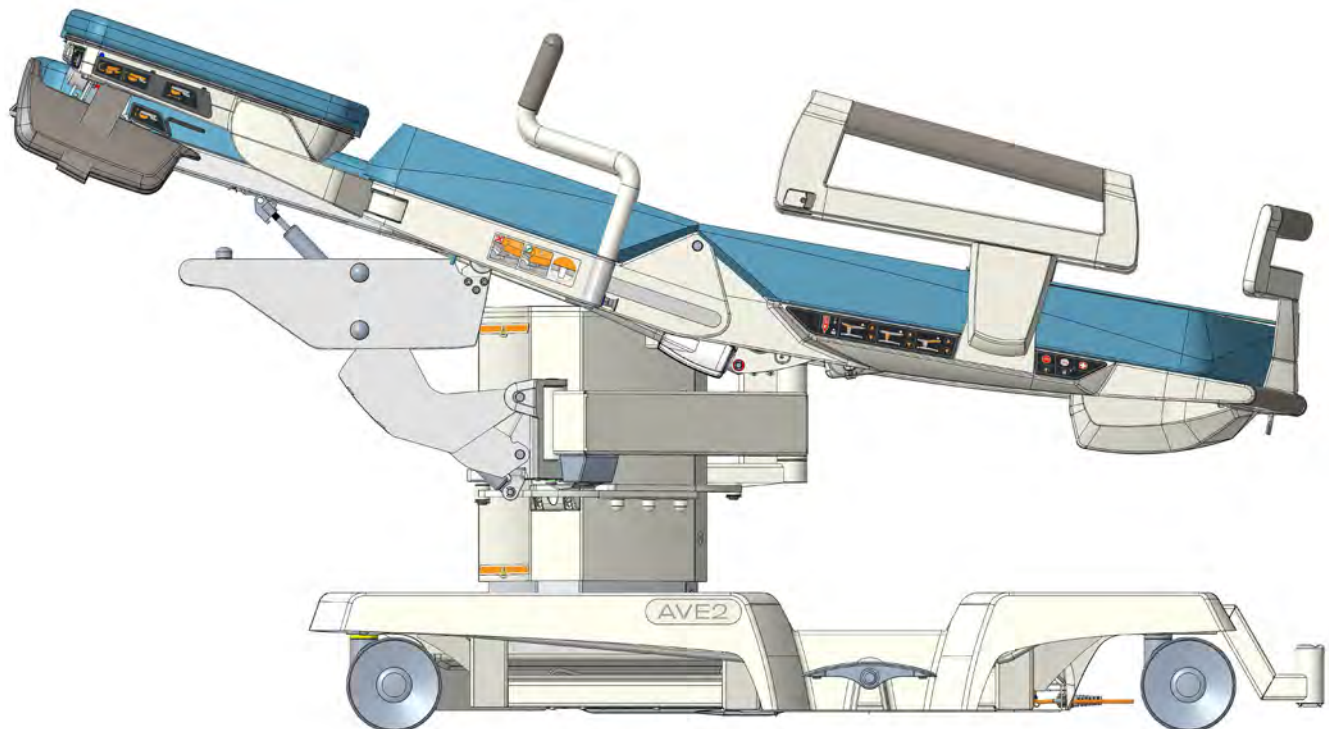

To reset the back section to its original position:

- ▶ Use motoric positioning (activates via hand control, side control panel or side rail panel)

9.5 Setting of the foot section



WARNING!
The load capacity of foot section is 150 kg maximum (330 lb)



WARNING!
The load capacity of foot section and leg rests together is 170 kg maximum (374 lb)



WARNING!
Do not overload the footrest due to the unsecured position. It is necessary to always secure the part in the end positions (parking, active)!



WARNING!
Foot section positioning (sliding in/out, lifting/lowering, inclination) always without load.

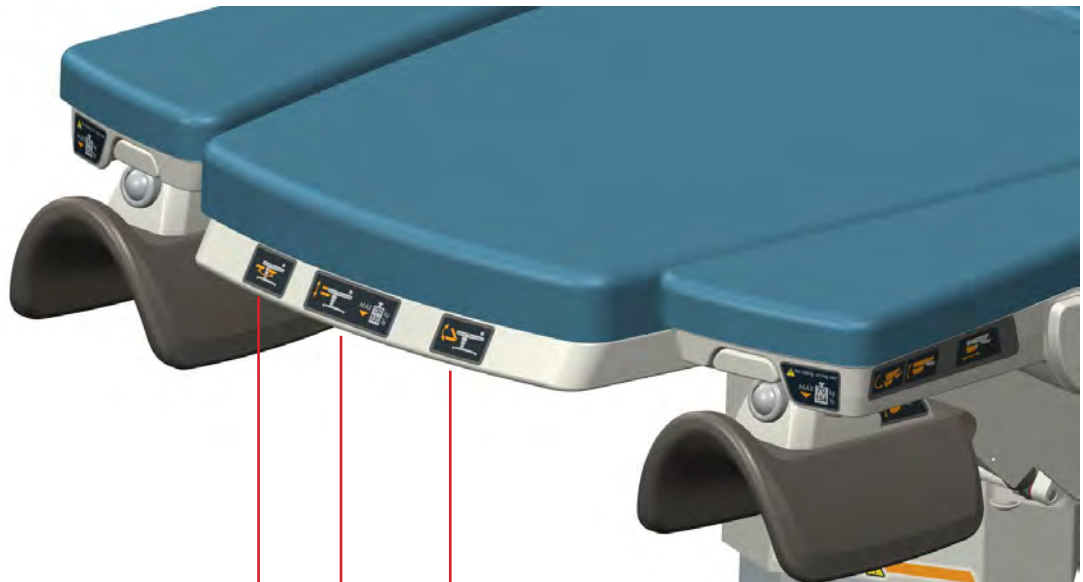

Folding/unfolding



Tilting up/down

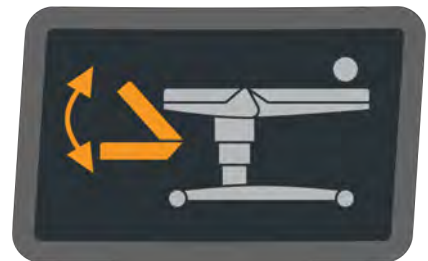

Lifting/lowering

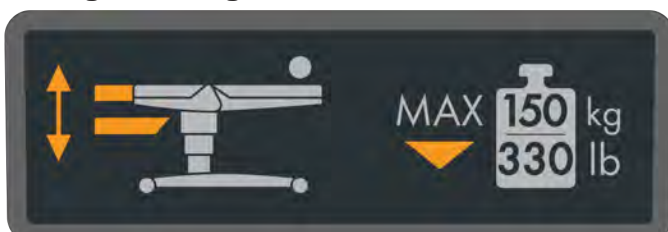

9.5.1 Folding/unfolding



WARNING!

Before folding, always make sure the foot section is in the lowest position and back section is not in Trendelenburg position



WARNING!

In case of putting aside the upholstery of the foot section from the bed, it must be placed on its wide laying surface on flat surface such as ground or bed. In case of lying the foot section on the edge side, the upholstery may be damaged due to heavy weight of the part.



WARNING!

When unfolding the foot section, other person(s) must not interfere

In lowered position, the foot section can be folded and locked in two positions:

► FOLDED

(the part is hidden under the seat section)

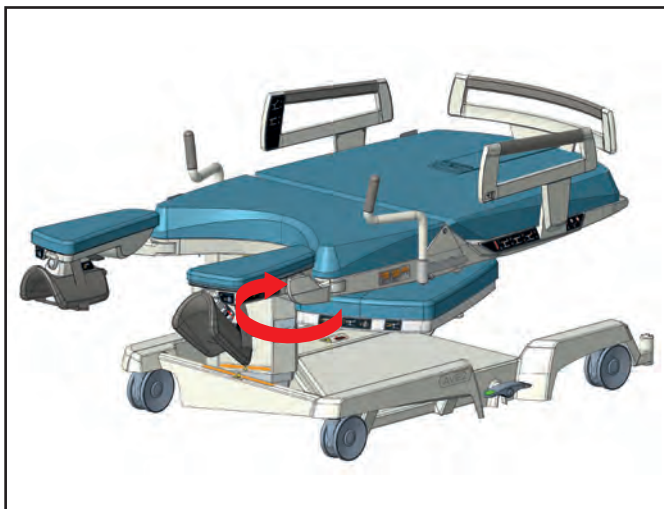

► UNFOLDED

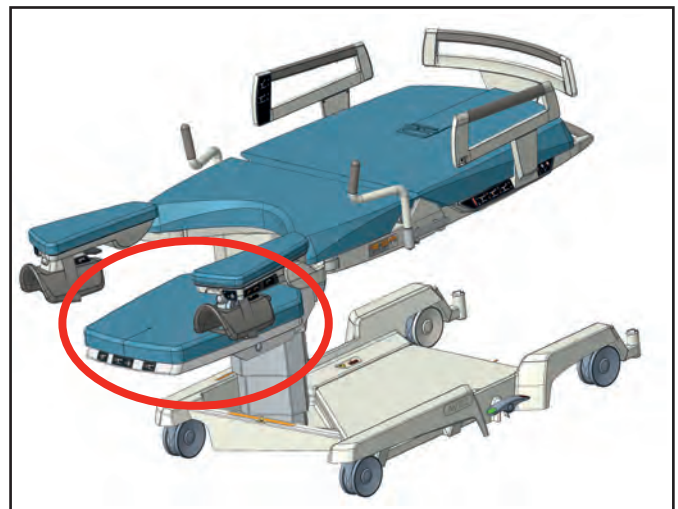

- Adjustment to any of these positions can be done by pressing the controller in the direction of the marked arrow and turning the foot section towards/outwards the operator.
- Once reached, the foot section will automatically lock in both positions.



9.5.2 Lifting/lowering

The surface of the completely pulled out foot section may be lifted up to the level of the seat. All listed positions of the foot section do not limit motoric setting of the birthing bed. Before loading the foot section, its correct locking should be checked by short moves to the sides.

LIFTING

- ▶ Pull the control lever with the right hand. At the same time grab the front edge of the foot section and pull upwards to the desired position
- ▶ Releasing the control lever locks the selected position.

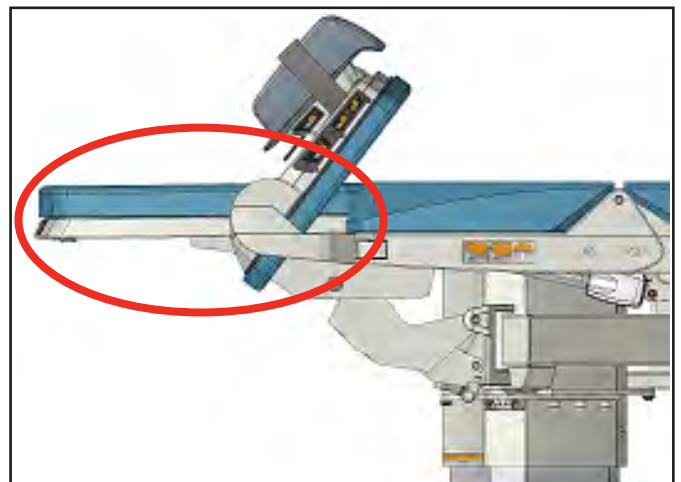
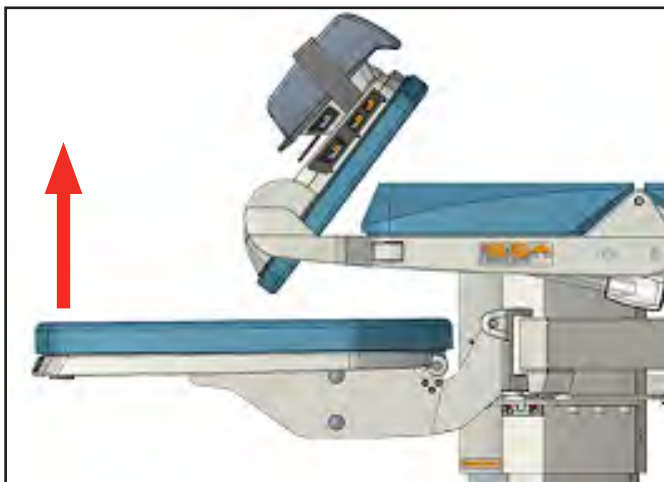

LOWERING

- ▶ Pull the control lever with the right hand and at the same time grab the front edge of the foot section and push downwards to the desired position
- ▶ Releasing the control lever locks the selected position

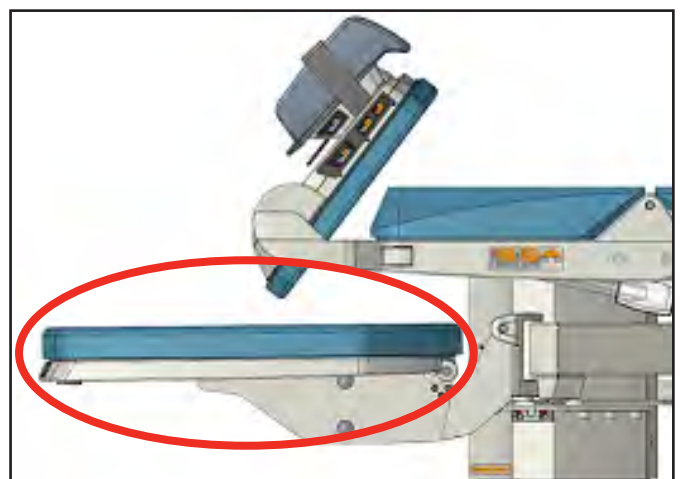
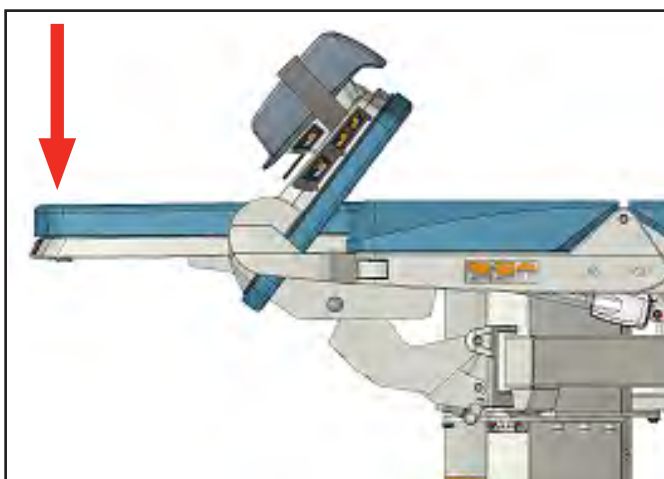

9.5.3 Tilting up/down

- ▶ Pull the control lever with the right hand
- ▶ Then push the foot section downwards
- ▶ You can lock the foot section in any position by releasing the control lever

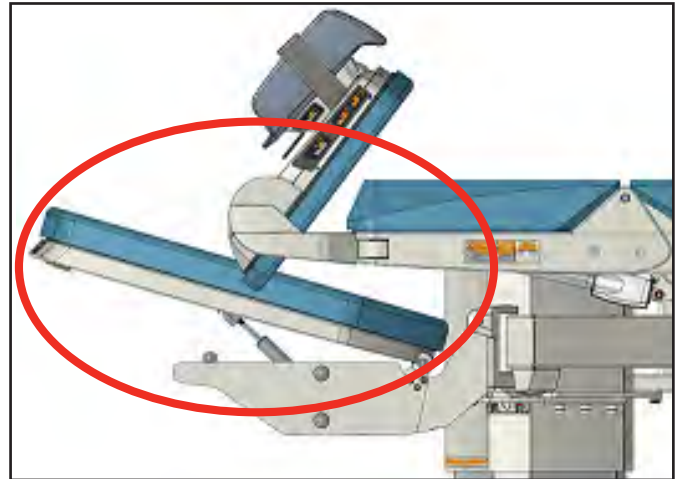
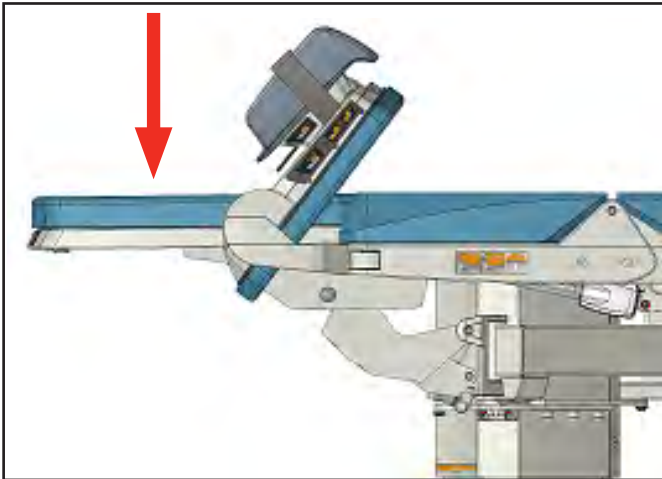

- ▶ Uninterrupted push downwards results in low horizontal position of the foot section

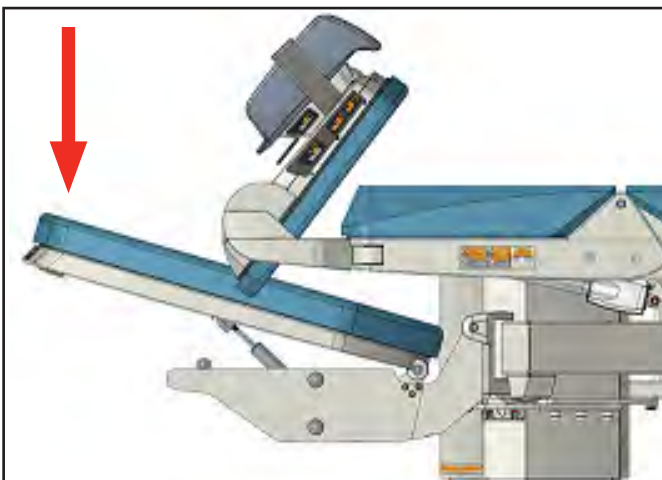

9.6 Adjusting the leg rests



WARNING!

The load capacity of one leg rest is 70 kg maximum (154 lb)



WARNING!

The load capacity of foot section and leg rests together is 170 kg maximum (374 lb)



WARNING!

Always brake the footrests plates before transport! This means to set up the lowest height level and turn them in a way that their edges do not overlap the edges of the footrests



WARNING!

Manipulation with the foot section or seating section and with the leg rests can cause a collision, especially when the leg rests are situated close to the foot section or above it



WARNING!

Undetachable leg rests may be used as feet support (Foot rest position), in the Gynecologic position and in the Horizontal position to maximize the bed surface

Undetachable leg rests may be used as feet support (Foot rest position), in the Gynecologic position and in the Horizontal position to maximize the bed surface.

BASIC OVERVIEW

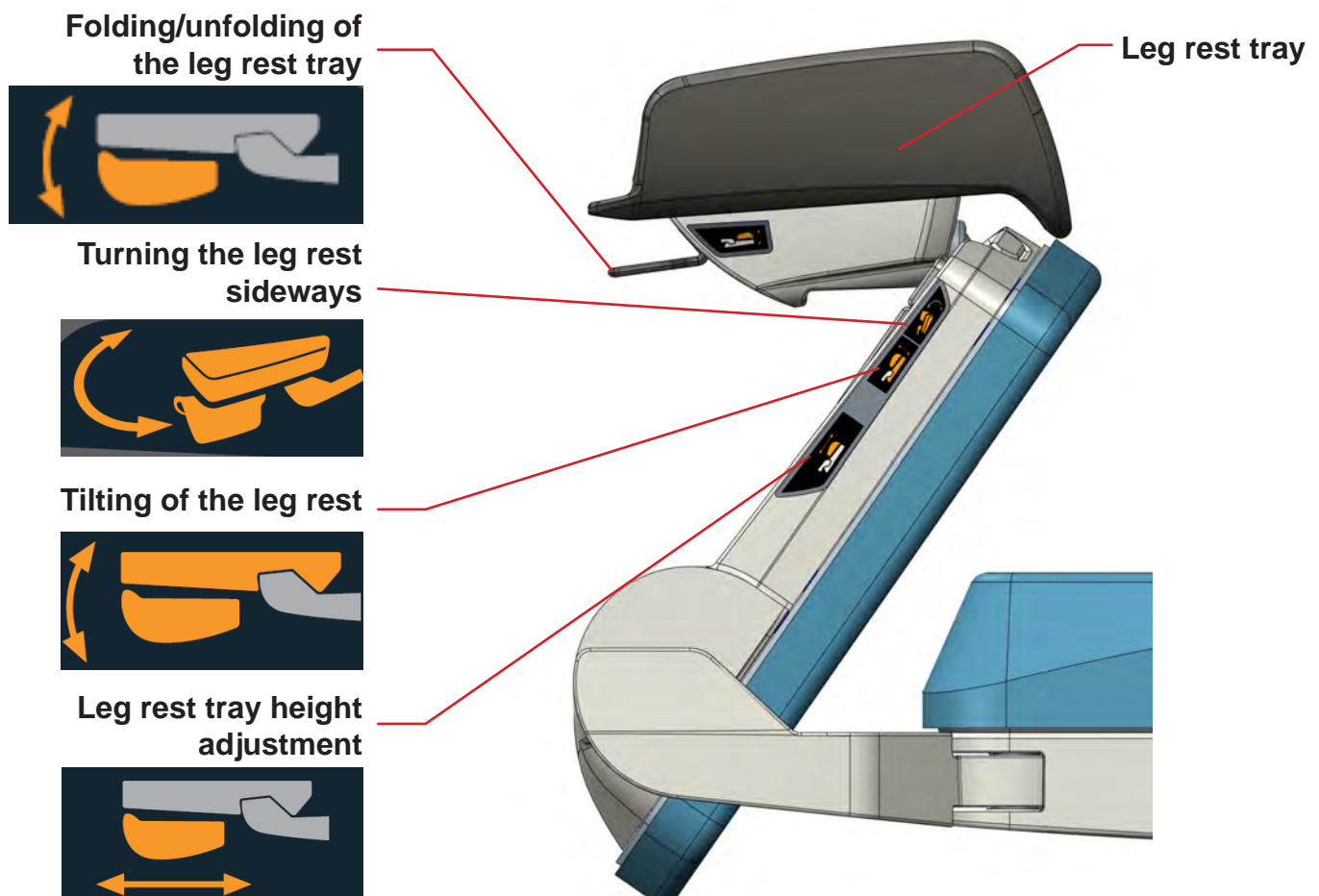

9.6.1 Gynaecological position

For positioning:

- ▶ Pull „Turning the leg rest sideways“ control lever
- ▶ and with same hand pull the leg rest in the desired position
- ▶ Then pull the „Tilting of the leg rest“ control lever as on the picture below

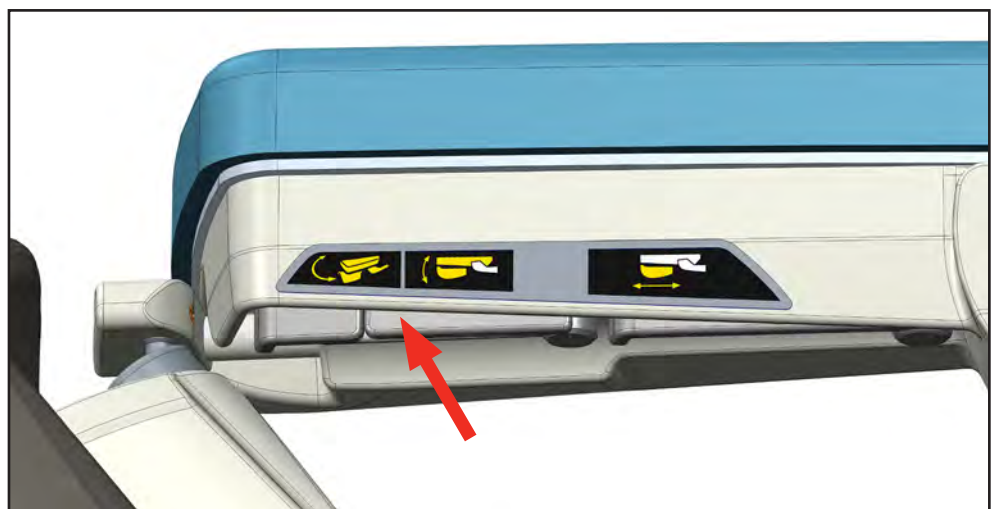
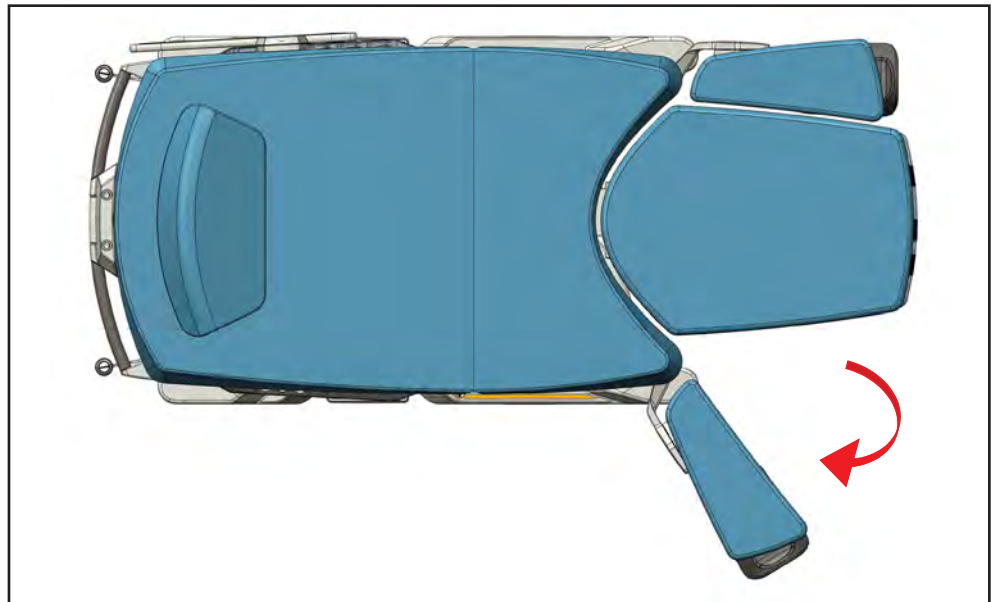
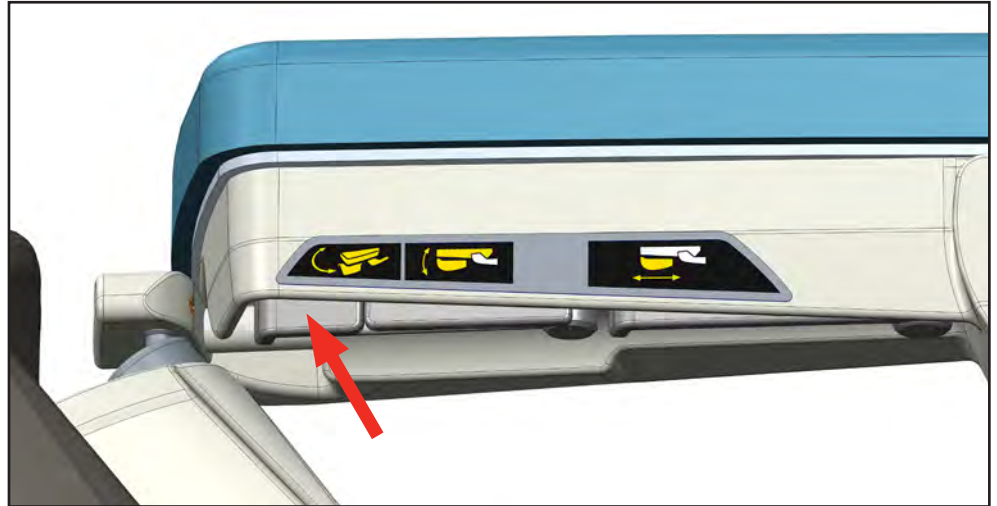

- ▶ and with same hand pull the leg rest in the desired position

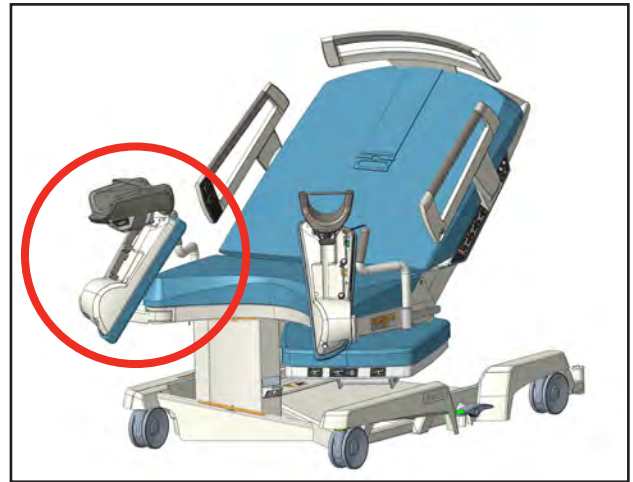
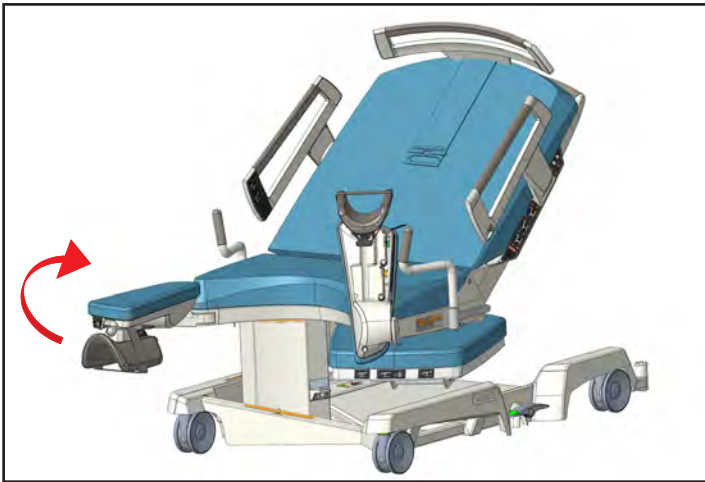

Then adjust the leg rest tray:

- ▶ With one hand pull the „Folding/unfolding of the leg rest tray“ control lever as on the picture below **(1)**
- ▶ Then with same hand pull the tray to the desired position **(2)**
- ▶ Releasing the control lever locks the tray in the position **(3)**
- ▶ To reset the tray to its original position, repeat the procedure reversely

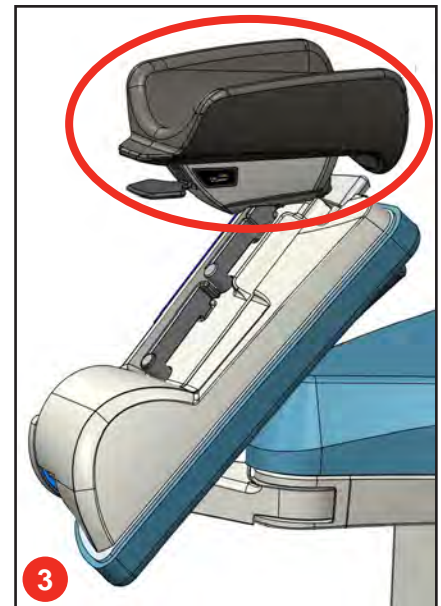
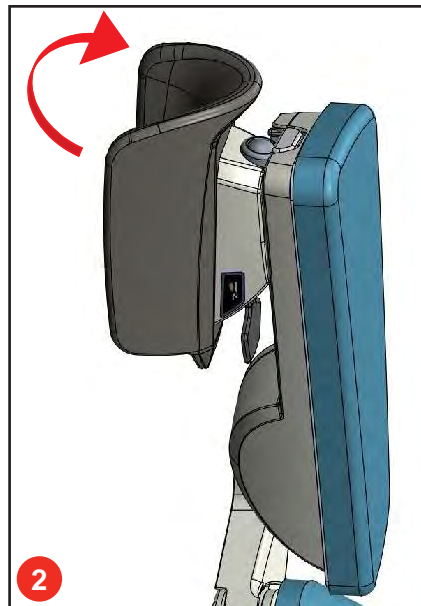
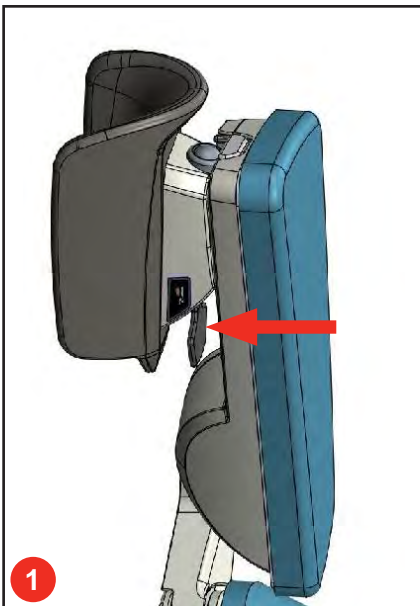

9.6.2 Foot rest position

The leg rests can be adjusted in the Foot rest position.

For positioning:

- ▶ Pull „Turning the leg rest sideways“ control lever
- ▶ and with same hand pull the leg rest in the desired position
- ▶ Then pull the „Tilting of the leg rest“ control lever

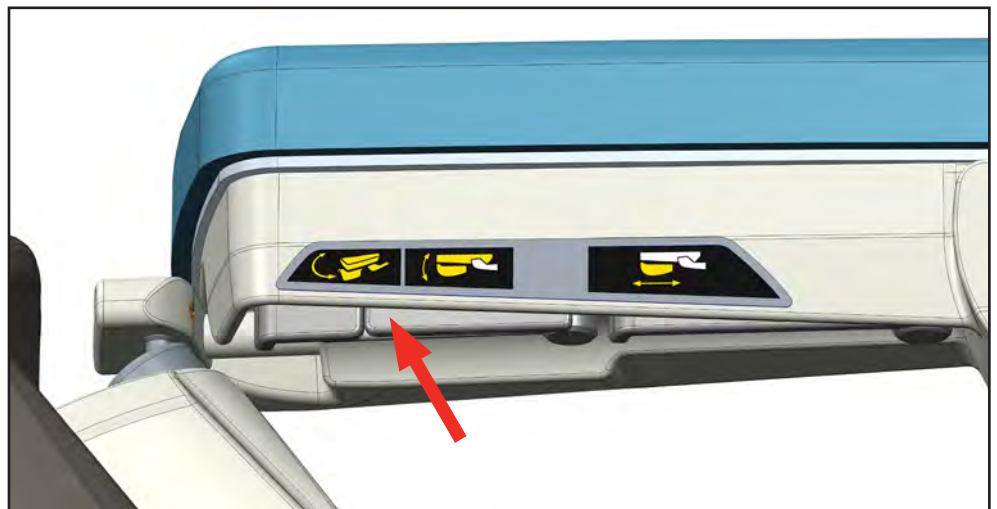
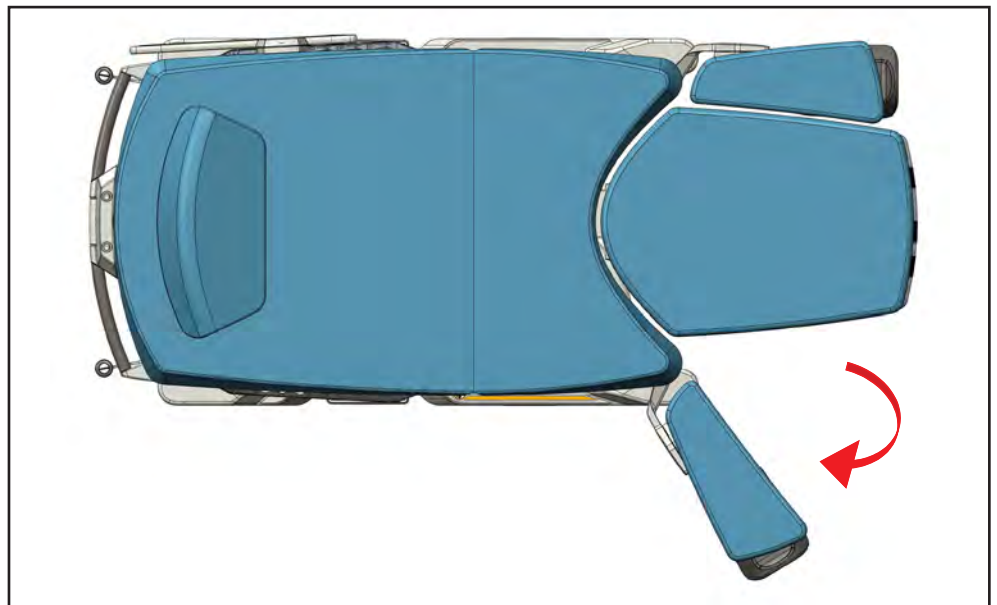
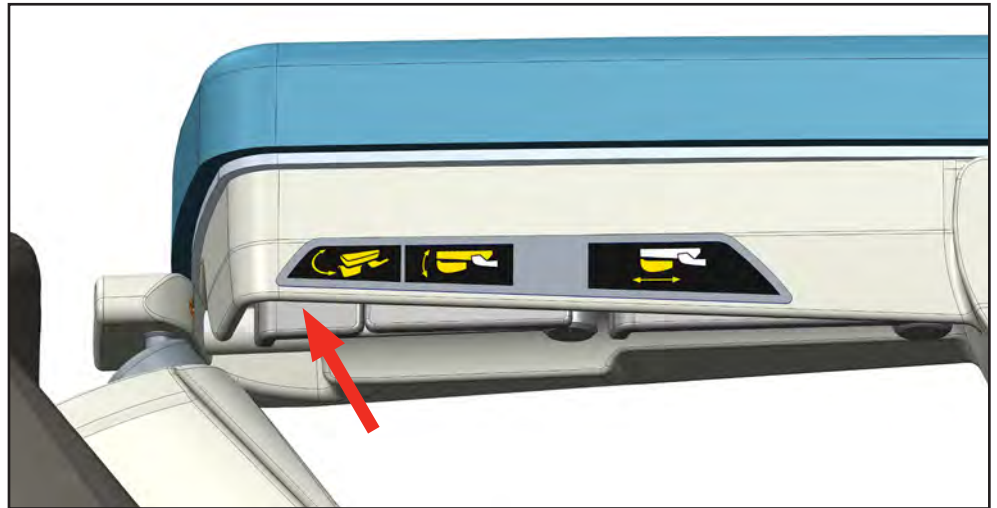

- and with same hand pull the leg rest in the desired position

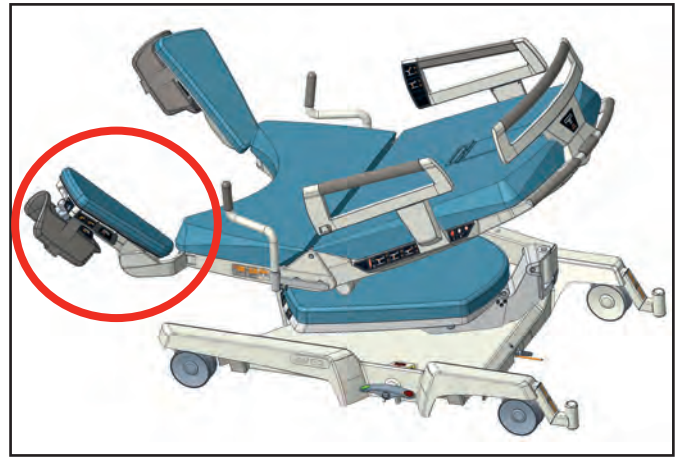
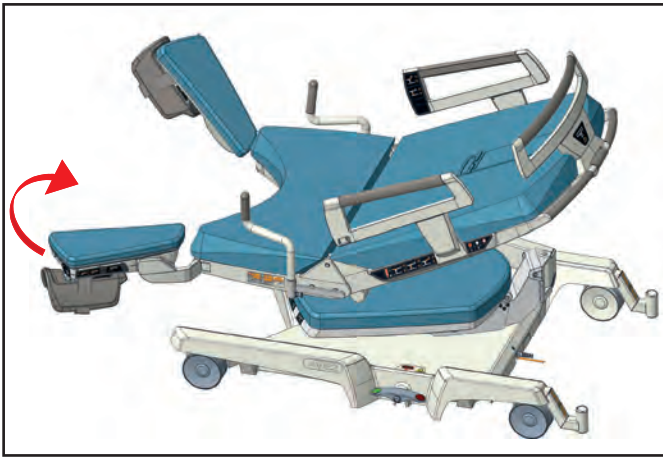

9.6.3 Maximum bed surface position

The leg rests can be positioned horizontally along the sides of the foot section. Due to this function, one laying surface can be achieved together with the seat and back sections.

For positioning:

- ▶ Pull „Turning the leg rest sideways“ control lever as on the picture below and with the same hand position the leg rest to straight direction, alike as the foot rest
- ▶ Then pull the „Tilting of the leg rest“ control lever and with the same hand position the leg rest in the horizontal position

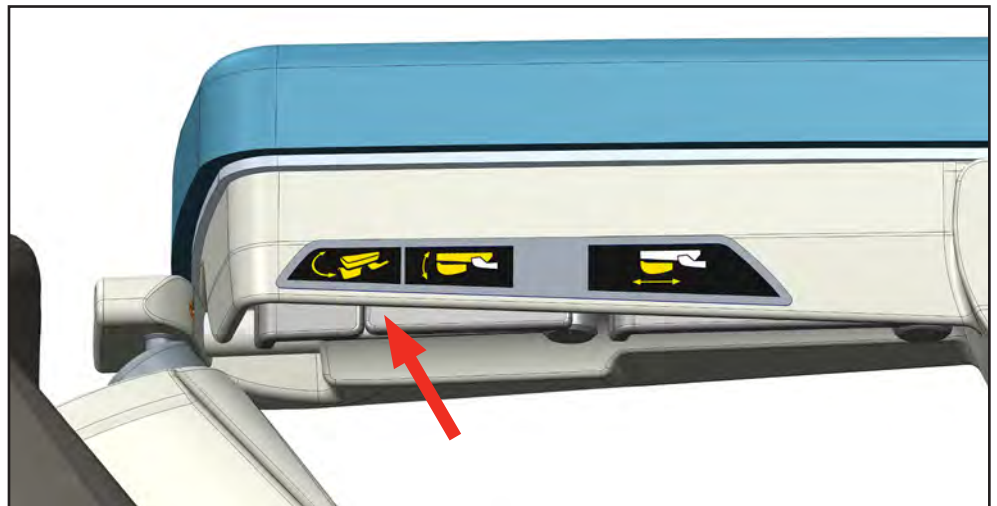
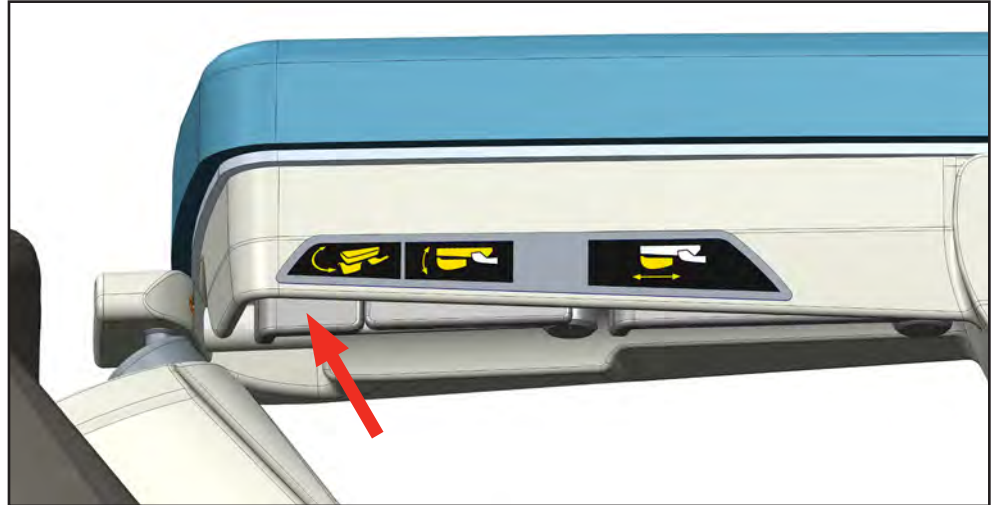

9.6.4 Turning the leg rests sideways

The leg rests can be turned sideways for better access to a birth mother.

For turning the leg rest sideways:

- ▶ Pull the control lever

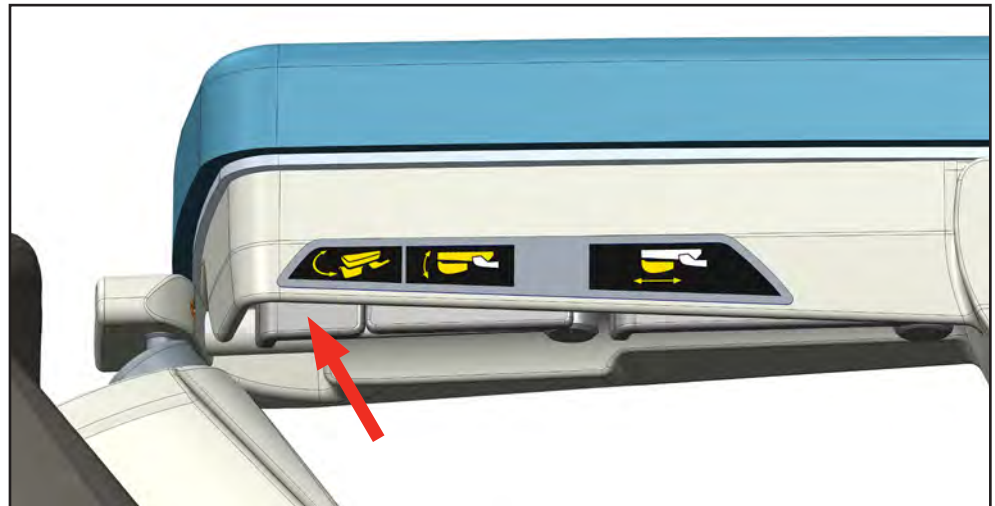

- ▶ Then pull the leg rest to the desired position
- ▶ Releasing the control lever locks the position

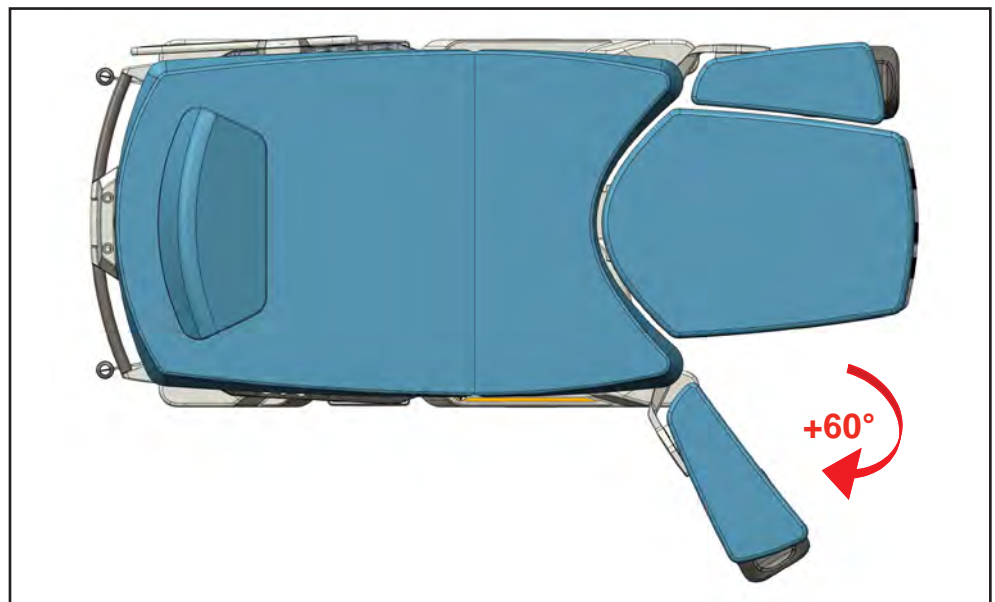

To reset the tray to its original position:

- ▶ Repeat the procedure reversely

9.6.5 Leg rest tray adjustment



WARNING!

Make sure that the footrest cups are handled correctly. Improper use of the footrests will damage the footrest upholstery



Leg rest tray can be individually turned sideways according to the physical proportions of the birth mother. **To do so, the leg rest must be in "Gynaecological position".**

- ▶ Then with one hand pull the control lever

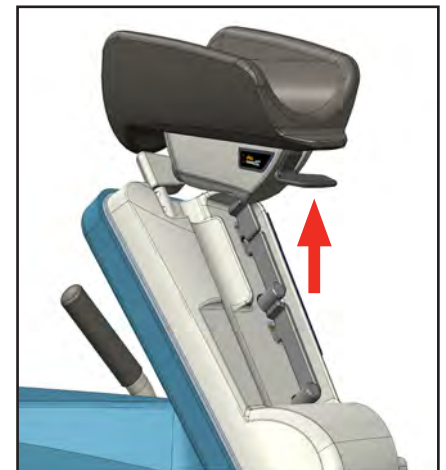

- ▶ Then with the same hand adjust the leg rest tray in the desired position
- ▶ Releasing the control lever locks the leg rest tray in the position

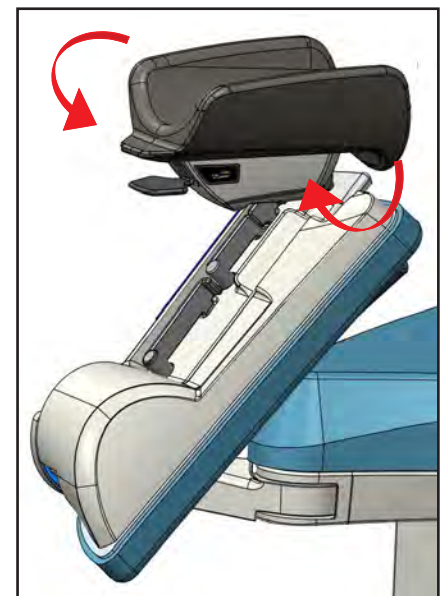
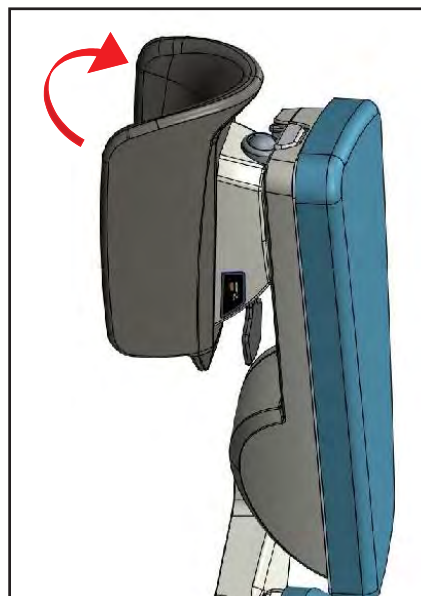

To reset the tray to its original position:

- ▶ repeat the procedure reversely

9.6.6 Leg rest tray height adjustment

Leg rest tray can be individually adjusted according to the physical proportions of the birth mother. **To do so, the leg rest must be in "Gynaecological position".**

- ▶ Then with one hand pull the control lever

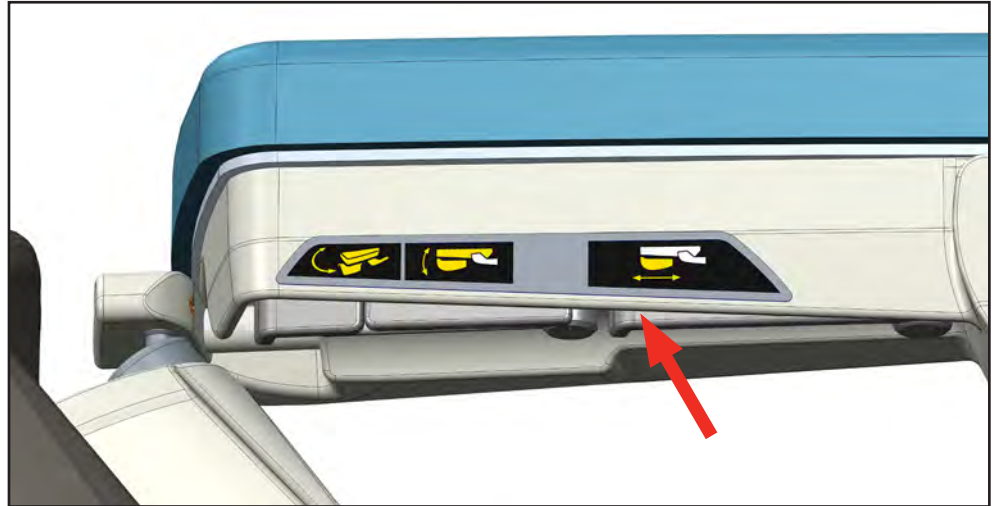

- ▶ With the other hand adjust the leg rest tray in the desired height
- ▶ Releasing the control lever locks the leg rest tray in the position.

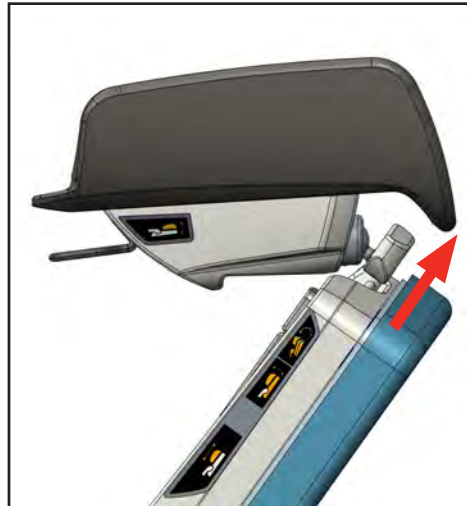

To reset the leg rest tray to its original height:

- ▶ Repeat the procedure reversely

9.6.7 Leg straps

Fixing straps for legs are integral part of each foot rest to enable better support of flaccid muscles of the mother-to-be during the stages of birth

- ▶ Loosen the strap (1)
- ▶ Place the mother's-to-be calf comfortably in the bowl of the foot rest (2)
- ▶ Fasten the strap (3)

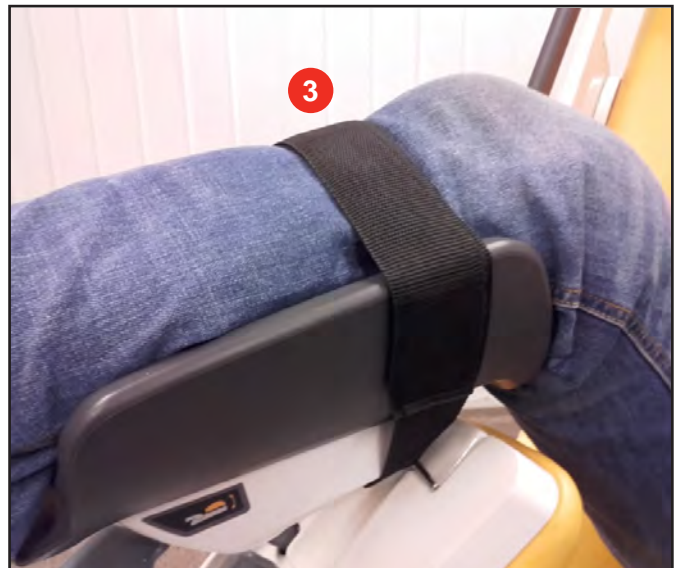
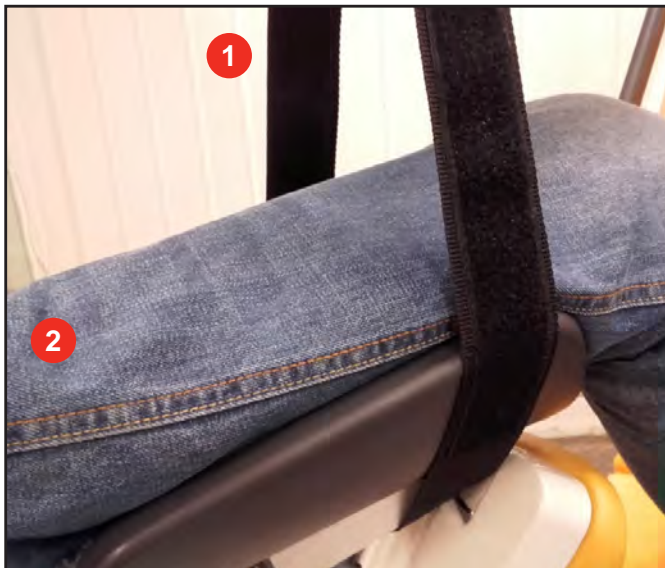

9.7 Backup Battery



DANGEROUS ELECTRIC VOLTAGE!

The batteries may be only replaced by the appropriate service personnel!



DANGEROUS ELECTRIC VOLTAGE!

The battery is intended solely for emergency power supply during power failures.



DANGEROUS ELECTRIC VOLTAGE!

In case that the insufficiently trained personnel will perform the replacement of battery, the danger situation may occur or the functionality of medical device may be reduced.



DANGEROUS ELECTRIC VOLTAGE!

Backup battery discharge is indicated by sound signal (1 s) after depressing any movement button. In this case, connect the bed to the mains immediately and charge the battery. The bed should not be used, when the battery has been completely discharged



DANGEROUS ELECTRIC VOLTAGE!

When the back-up battery is completely discharged, the recharging to the minimum level (allowing the use of this back-up battery again) will take at least one hour time. If you require the full charging of the battery, the necessary time for charging will take at least 24 hours!



DANGEROUS ELECTRIC VOLTAGE!

The fully charged back-up battery will last in the stand-by mode for approximately 1 to 2 months (at the optimum temperature of 15 to 25°C). The allowed maximum temperature for the battery is 50°C!



DANGEROUS ELECTRIC VOLTAGE!

The fully charged battery provides for the necessary functionality of the birthing bed (i.e. positioning of lift, tilting of the supporting systems, calling the nurse, and Trendelenburg), namely with minimum of four cycles, so that it will be possible to set the birthing bed into the basic safe position



DANGEROUS ELECTRIC VOLTAGE!

In case that the power supply of the bed will be interrupted, the "Call nurse" function will be usable for the time period of 1 to 2 months (provided that the positioning of the bed is not used!).

The birthing bed includes fully charged battery. The battery is automatically charged from the control unit and does not require special maintenance.

Indication of battery charging mode

- ▶ Battery charging mode is indicated by a green indicator LED on side control panel

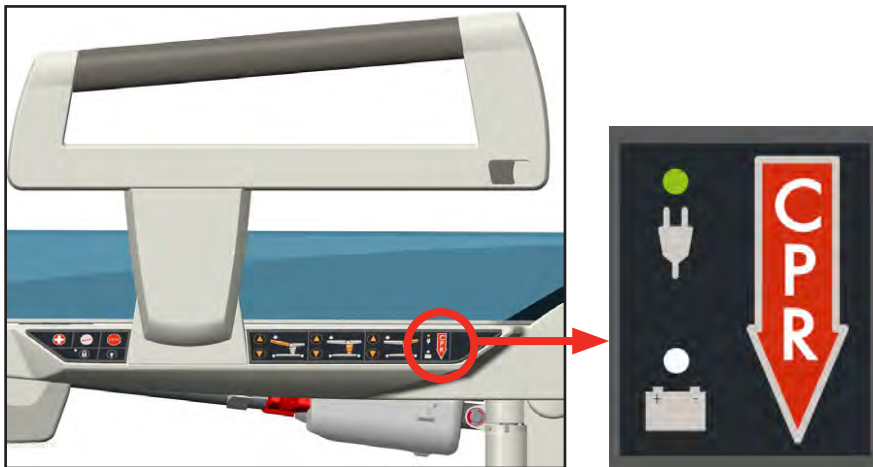

Battery status indicator

- ▶ **Light on:** battery disconnected or defective
- ▶ **Flashing:** charging the battery
- ▶ **Light off:** charging completed

9.8 Grab handles, detachable (R/L)



WARNING!

When simultaneously using hand grips and setting the leg rests to the Foot rest position, collision may occur! Hence, it is necessary to pay attention to avoid injury of the personnel and/or the mother in labour when adjusting the leg rests



WARNING!

The handles can be attached only in the position showed below, it is forbidden to fix them with the rubberized hold “downwards”.

The standard grab handles are designed as the detachable ones

- ▶ For removal, the handles, drag the arresting element (1) to unlock it and using your second hand, pull the handle out from its seat (2).
- ▶ For inserting, simply push-in the handle - the safety member will fix the handle in its appropriate position automatically

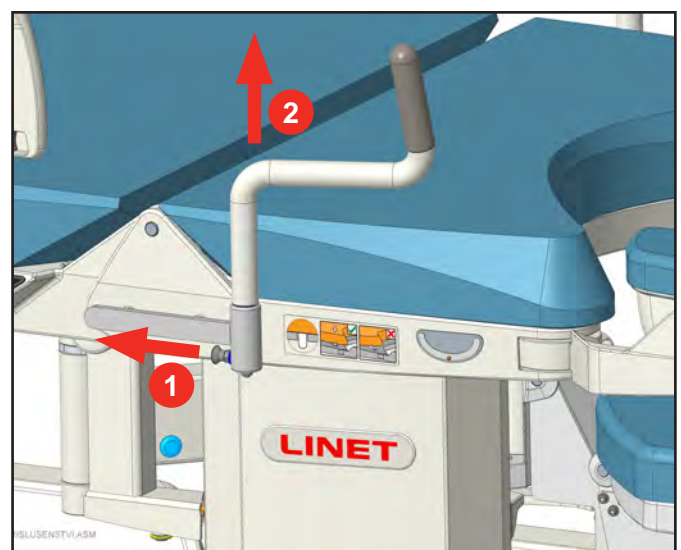

9.9 Grab handles, non-detachable, foldable (R/L)



WARNING!

When simultaneously using hand grips and setting the leg rests to the Foot rest position, collision may occur! Hence, it is necessary to pay attention to avoid injury of the personnel and/or the mother in labor when adjusting the leg rests.

The optional grab handles (at extra costs) are designed as the non-detachable ones. These handles provide for "parking" and "active" positions.

- ▶ In order to position the handle into the "parking" position, press the safety member located on the side of the handle, and using your second hand, put the handle below the seating part of the bed
- ▶ For inserting, simply pull-out the handle - the safety member will fix the handle in its appropriate position automatically



9.10 Holder of infusion stand

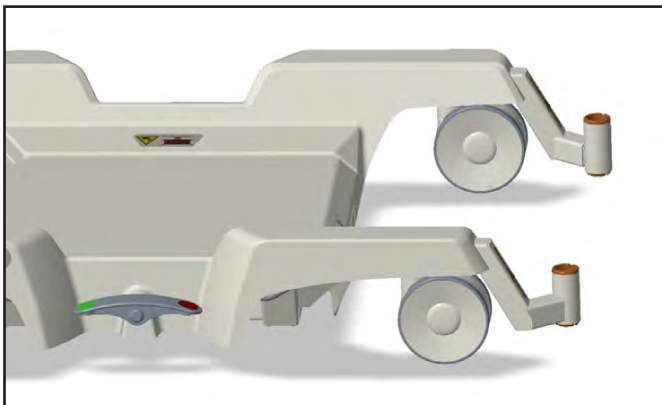

Double-way undetachable infusion holder is used to fix the infusion stand.

9.11 Equipotential coupling

The delivery bed is fitted with a coupling for synchronizing the potential with other electrical medical equipment. The coupling is located behind the bed under the lying surface of the bed. The bed is interconnected to the other device by means of a cable (not supplied with the bed) that is connected easily by its end to the coupling

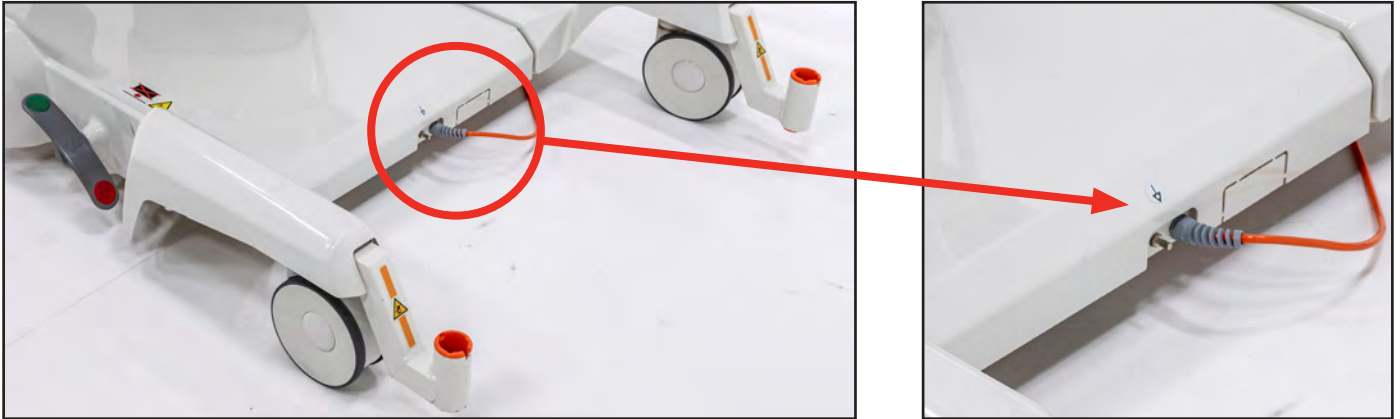

9.12 Replaceable leatherette upholstery / mattress set DUOCOAT



WARNING!

Incompatible upholstery/mattress set can cause risk!



WARNING!

When changing the bed, always make sure that the upholstery/mattress set fits correctly on the seat and back sections of the bed. Spaces filled with fabric do not fulfil their function, do not hold silicone pins of the upholstery/mattress set and as such, pose a risk of injury of the labouring woman or damage to the plastic parts of the mattress.

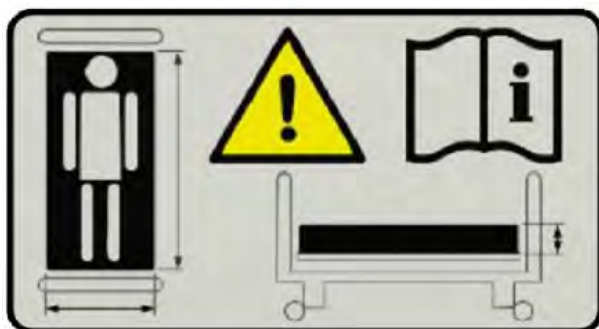

The birthing bed is fitted with replaceable upholstery/mattress set. In case of damage to the upholstery/mattress set (e.g. mechanical or physical-chemical damage), it is necessary to replace the upholstery/mattress set for a perfect one in order to maintain the birthing bed hygienic compatibility and overall safety.

In other cases, the manufacturer recommends replacing the upholstery of bed surfaces/mattress set after 5 years of use. Date of the upholstery production can be found on the reverse side of the back and foot sections. Date of production of the DUOCOAT mattress set can be found on the labels that are sewn in the top cover and in the covers of the inner cores.

9.12.1 Leatherette upholstery

The upholstery of the bed surface and the upholstery of the foot section can be removed from the birthing bed, but the upholstery of the leg rests cannot. The bed laying consists of the bed upholstery, the foot section upholstery and the leg rest upholstery.



9.12.2 DUOCOAT mattress set



WARNING!

The top cover of the mattress is made of elastic material. The mattress cover may experience slight rippling and wrinkling of the cover material during use. These ripples or wrinkles are due to the characteristics of the cover material and therefore cannot be covered by warranty or claims.

The DUOCOAT mattress set consists of the lying area mattress, foot section mattress and the upholstery of the leg rests. When cleaning, the mattresses of the lying area and of the foot section can be removed from the delivery bed, but the leg rest upholstery cannot.

The mattress consists of upholstered foam cores, which are inserted in a waterproof washable cover.



10 Accessories

10.1 Cable hand controller



WARNING!

For safety reasons it is restricted to pass the hand controller cable under the birthing bed to reach the other side!

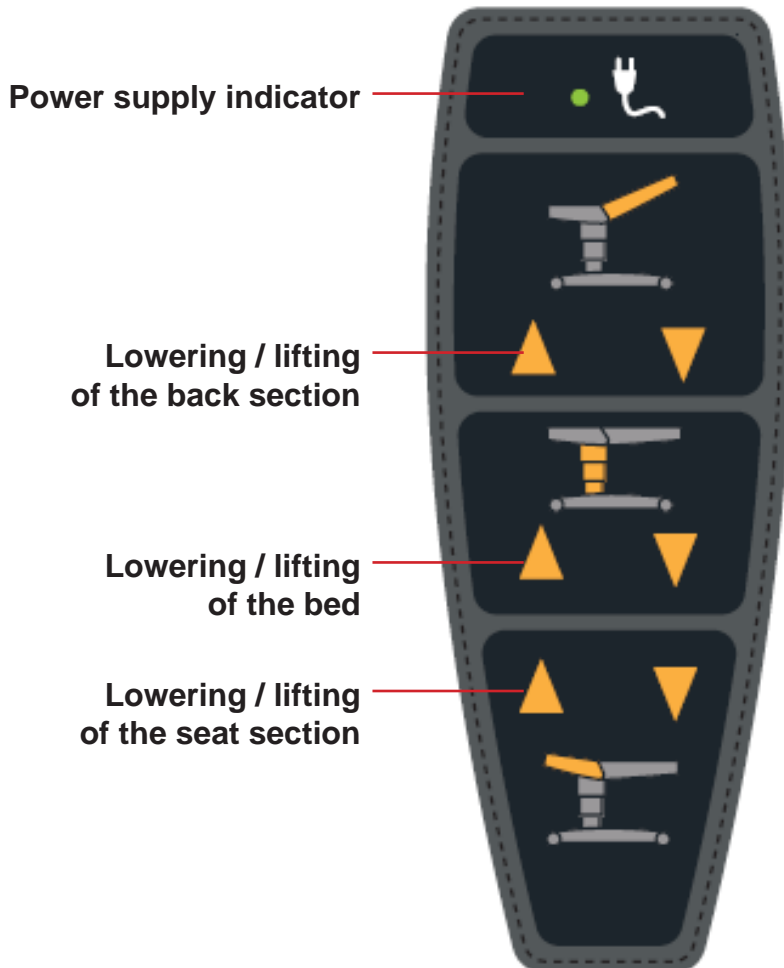

The operator may use the hand controller buttons to set the height position of the seat and back section inclination. The functions of the control buttons are shown in the picture. Motoric setting is done by pushing and holding the desired function buttons.



Recommended position of the manual control unit: only on the left side of the seat section

10.2 Supporting bar



WARNING!

Maximum weight load of the supporting bar is 70 kg in all direction (154 lb)

Supporting bar is vertically locked up, it may be ejected from the holder in the upward direction!

- ▶ After having pulled out the cross-bar, it is necessary to drag both arresting elements to unlock them

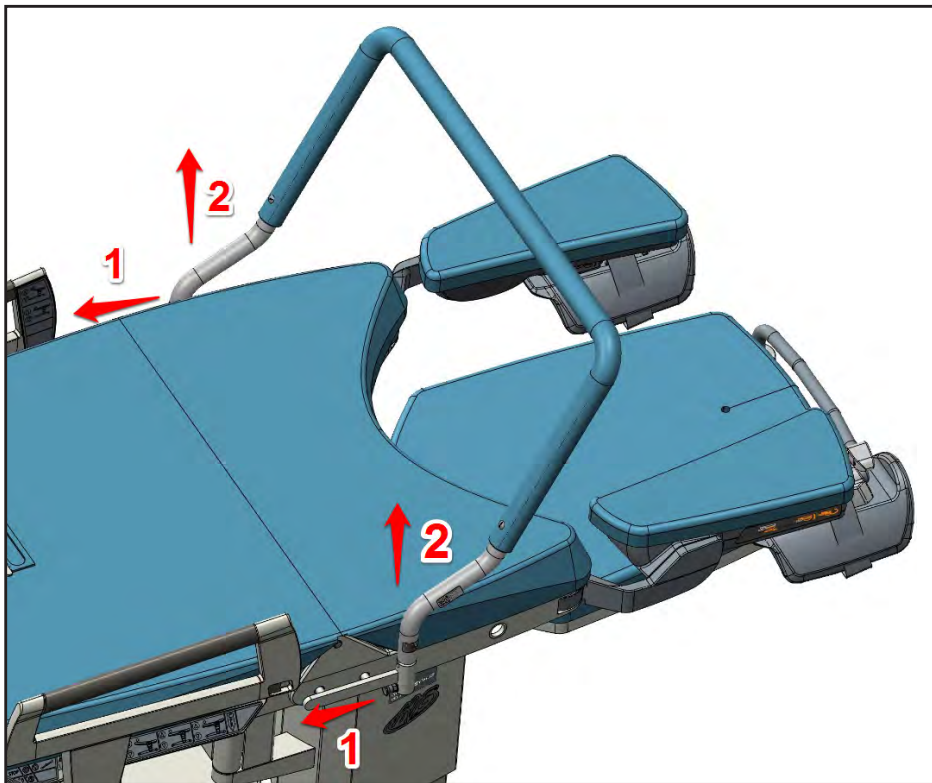

10.3 Undercarriage light

- ▶ The under carriage light is turned on by short pressing the button on the side control panel of the birthing bed
- ▶ Repeated push of the button switches the lighting off

Light is controlled by the personnel only



10.4 Infusion stand, stainless steel, telescopic



WARNING!
Max. load-carrying capacity of one hook 2 kg!

Infusion stand is only used to hold infusion. It is restricted to use it for manipulation with birthing bed. It is also necessary to be cautious when manipulating with the bed in order to avoid the collision between the infusion stand holder or possibly the infusion stand and the other objects situated close to it.

10.5 Eurolath along the seat section



WARNING!
Ensure that when the chair moves up and down, the surrounding objects do not collide or get caught with the Eurolath



The eurolath is used for placing the given accessories, such as armrests, hand control, infusion stand.

10.6 Rear bed-head



WARNING!
To allow the anaesthesiologist better access to the head of a birth mother, always remove the bed-head!



WARNING!
Bed-head is not intended for the suspension of a woman in labour by means of an auxiliary rope, bed sheet, or a towel!

Rear bed-head represents a safety element of the bed and can be used by the birth mother as a handle. The bed-head is automatically locked against movement. After pulling the security lever „PULL“, the bed head can be removed from the bed with the other hand.

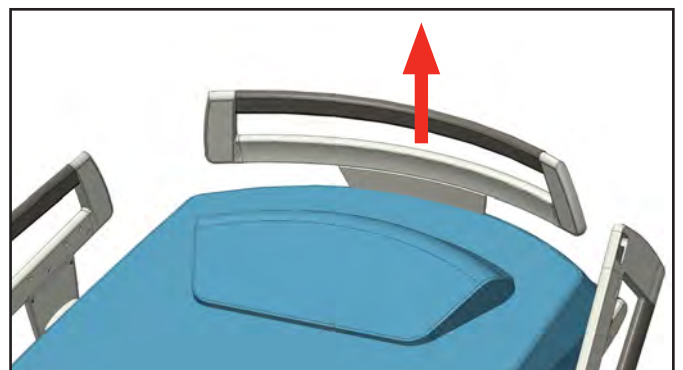

10.7 Doctor's chair (ergonomic)



10.8 Doctor's chair



10.9 Front bumper on foot section



WARNING!
Maximum weight capacity is 70 Kg (154 lb)

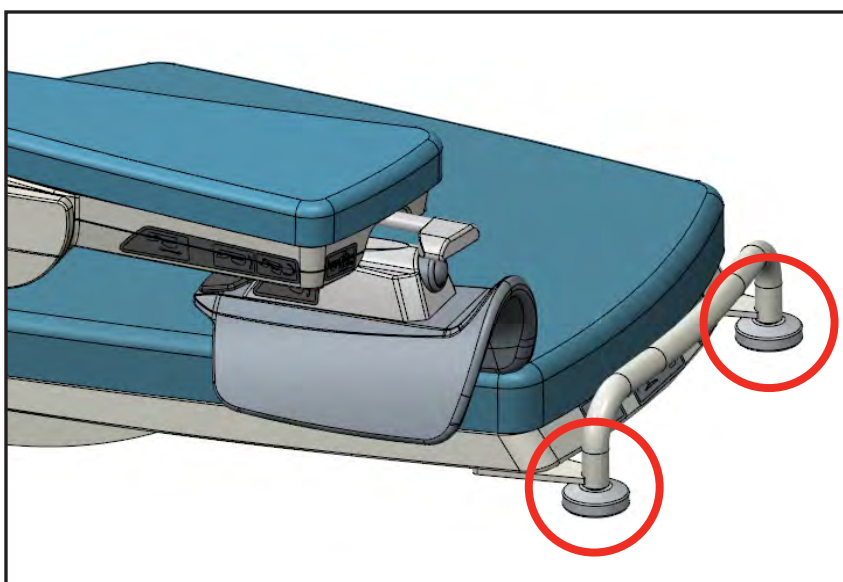

Accessories can be attached to the holder and it serves as foot section protection as well. The set contains two side bumpers.

10.10 Upper mattress (for 100 mm cushioning)

The accessory is primarily used after post-partum; it increases the comfort of the resting mother.



10.11 Upper mattress (for 130 mm cushioning)

The accessory is primarily used after post-partum; it increases the comfort of the resting mother.



10.12 Tray on the swinging holder



WARNING!

Tray may only be manipulated when the lying section of the foot rest section is adjusted in the low position!

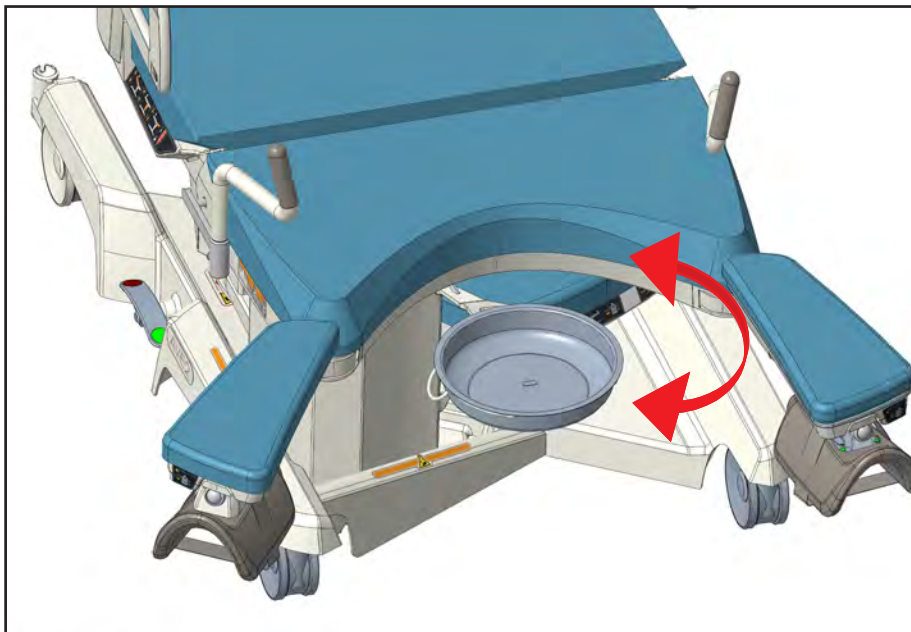

The stainless steel tray is foldable on the swinging holder forth and backwards. It is possible to remove the tray from the holder in the forth position. Volume of the tray is 4,5 litres.

10.13 Nurse call



WARNING!
The control elements of the nurse call function cannot be deactivated!



WARNING!
If the power supply of the bed is disconnected, the Call nurse function can work for about 1 or 2 months (if the bed positioning is not used).

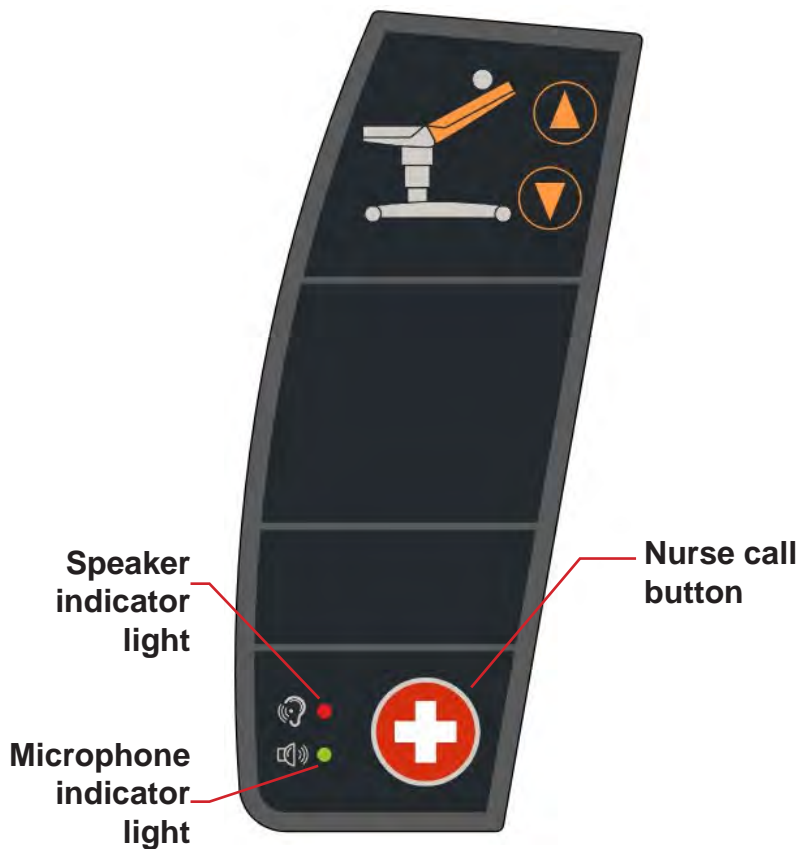

The nurse call button is located on the inner side of the side handle control panel (on the side of the labouring woman).

- ▶ After pressing and releasing the button an indicator light lights up, indicating that a nurse has been called

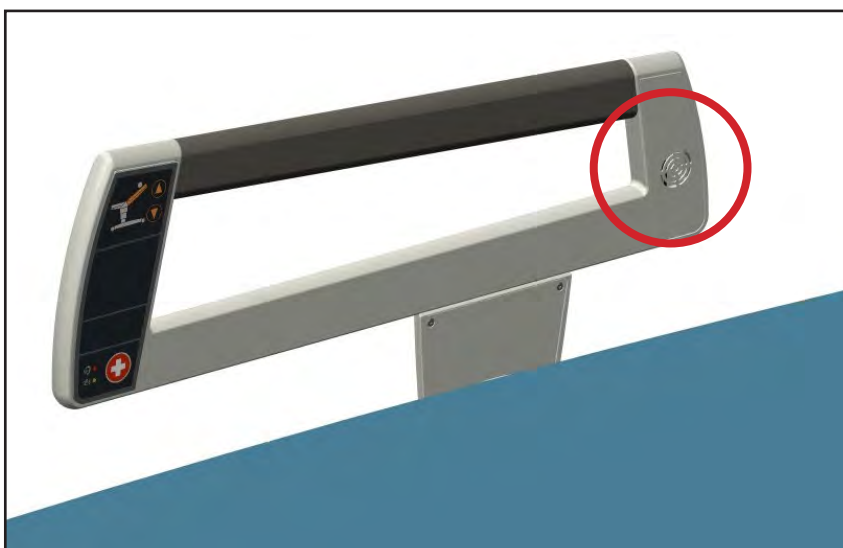

- ▶ Subsequently, the labouring woman can speak into a microphone with a set of speakers located in the rear part of the handle

10.14 Front bumper fitted on the leg rest (R/L)



WARNING!

Always park the leg holder trays before transport! Adjust the lowest position and move so that they do not overlap the contour of the leg rest



Intended for hanging the accessories and, at the same time, leg rest protection.

10.15 Head rest

Comfort head rest can support the head of the woman in childbirth. Thanks to its ergonomics it can also serve to fill the lumbar part of the patient as to support her back, so that the spine maintains its natural curving. With lifted back section (sitting position), the head rest also helps smaller patients to achieve optimal position on the edge of seat section.



10.16 Bowl



The bowl is made of stainless steel, with the capacity of 8 liters. The bowl cannot be shifted below the seat section (after giving birth, it is always recommended to remove it and park only the bowl holder).

10.17 Instrument tray



This flat, stainless-steel tray is in most cases used for tools necessary in post-delivery sutures. The tray can be parked below the seat section and, where required, you can place this tray onto existing and deeper trays (4,5I and 8I).

10.18 Protractor of the seat part, Protractor of the back part



WARNING!
The protractor is only for information!

It is used to inform about the inclination of the back or the seat part of the delivery bed

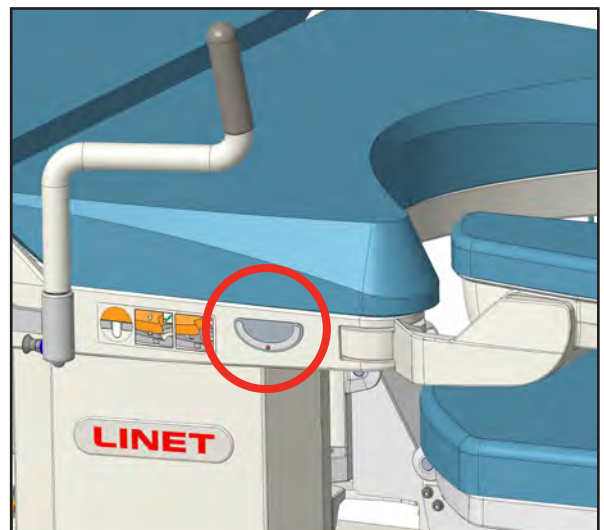
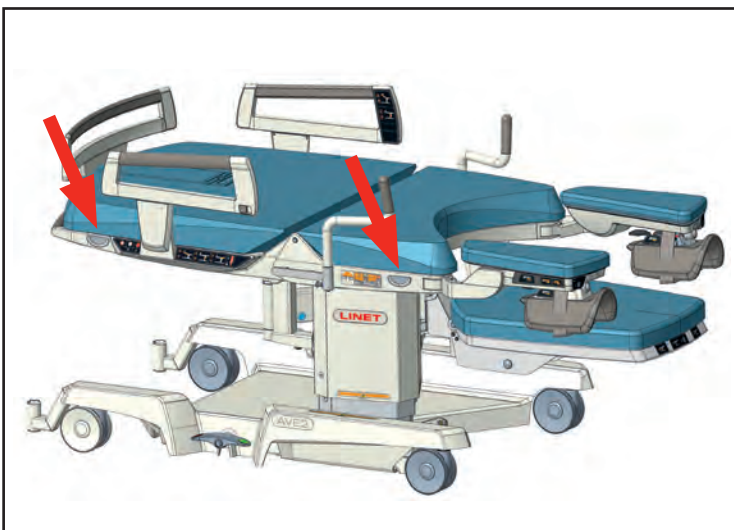

10.19 Bracket for oxygen bottles



WARNING!
Maximum load 10 kg (22 lb)!



WARNING!
The holder cannot be used on the bed on the right side of the DIN rail with respect to the patient sitting on the bed!



WARNING!
It can be used on the left side of the patient while sitting on the delivery bed. There is a risk of collision when positioning with the leg rest!



WARNING!

When positioning the delivery bed downwards, there is a risk of collision between the empty bracket and the oxygen bottle bracket with the foot / legs of the operating personnel. Risk of deterioration of the bed or injury to the patient, staff or a third party!



WARNING!

Do not step on the plastic frame cover when handling the bed with an oxygen bottle holder!



WARNING!

Before actively using the oxygen bottle holder, always check the correct dimensions of the oxygen cylinder, including the top of the bottle. Larger dimensions can collide with positioning bars!



WARNING!

When positioning the seat, the oxygen bottle holder also becomes mobile



WARNING!

When using an oxygen cylinder, always check the patient's movements on the bed. There is a risk that the patient will cling to the oxygen bottle, thinking he has caught the sides of the bed! Risk of deterioration of the bed or injury to the patient, staff or a third party!



WARNING!

Never remove the holder and the oxygen bottle holder together

Installation procedure:

- ▶ Place the bracket on the right DIN rail **(1)** in the direction of the arrow **(2)**. The bracket is designed so that it cannot be mounted on the opposite bracket (left DIN rail).
- ▶ Then insert the oxygen bottle vertically into the holder **(3)**

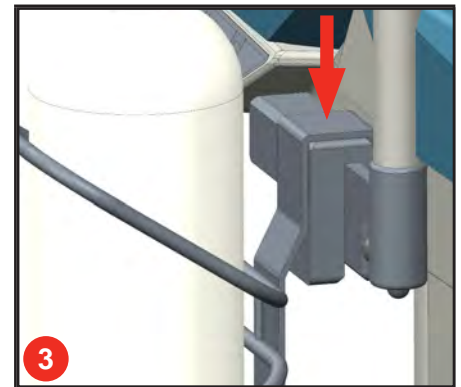
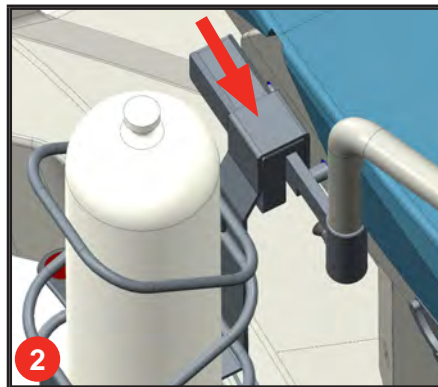
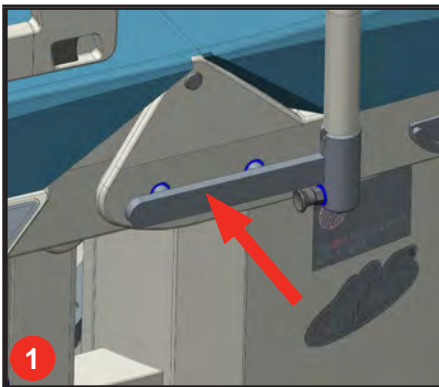

Contrary procedure

- ▶ To remove the oxygen bottle holder, the procedure must be carried out in the reverse order to placement on the delivery bed

10.20 Patient card



WARNING!
Condition of the order including the front bumper of the leg rest



WARNING!
Snap only to the front bumper on the leg rest!



WARNING!
If the patient's card is hung in other places, such as the bed side or the headboard, there is a risk of instability. These parts of the bed are mobile! Therefore, we do not recommend hanging the patient card in these areas other than the front bumper on the leg rest!

Use to hang the patient card in A4 format.



1. Front bumper on the footrest
2. Patient card

1 2

10.21 Baby plate



WARNING!
The maximum load of the baby plate is 10 kg (22 lb)!



WARNING!
The Baby plate is a removable accessory!



WARNING!
When using the baby plate including when the new-born is placed there is always necessary that there is a permanent presence of staff!



WARNING!

It is absolutely forbidden to see staff moving away from the baby plate when the new-born is lying there!



WARNING!

The Baby plate can only be used by staff trained for this!



WARNING!

When mounting the baby plate on the bracket and after hearing the click, check by pulling towards you that the baby plate is correctly insured! The safety lever must be in the down position (safety position)



WARNING!

The Baby plate is not made for the transport of the new-born!



WARNING!

When installing the new-born on the baby plate, always do it on the longest part of the mattress! The installation of the new-born on the shorter part of the mattress may fall to the ground!

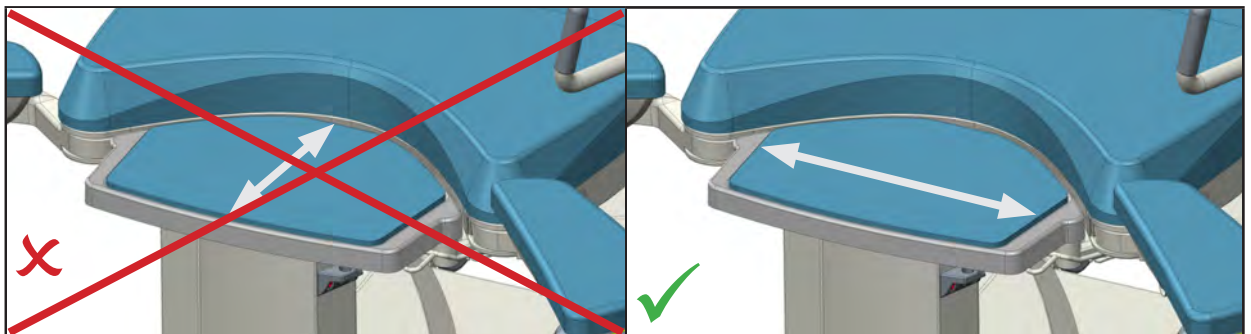

WARNING!

The baby plate moves with its seat, so that there is no distance between the genital matrix during childbirth and the surface of the baby plate. This must be considered!



WARNING!

The baby plate should not be installed upside down! The correct position of the baby plate before installation on the delivery bed is the one with the padding upwards



WARNING!

Do not place the newborn on the baby plate without a mattress! Always use a mattress covered with the bed-linen provided by the hospital



WARNING!

The baby plate cannot be used with a bowl and the foot section of the delivery bed. There is a risk of collision or damage to bed components or injury to the patient, staff or a third party! When using the baby plate, the revolving bowl and the leg rest cannot be used together

The baby plate is used to drop the new-born for a short period of time. The umbilical cord is cut when the new-born is placed on the baby plate and then placed on the breast of his mother, or on another table to perform some necessary procedures. Then it can be used to expel the placenta and control it.

If the baby plate is not used it must be removed from the bed and stored in the roomti

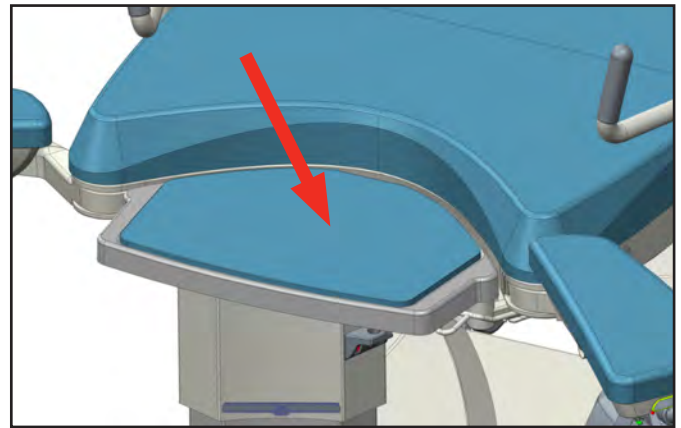

PPB-074 Version with mattress

Procedure for mounting the baby plate on the delivery bed

- ▶ When mounting the baby plate on the delivery bed, the locking levers must be moved to the unlocked position (in the direction of the arrow). Then slide the baby plate by the handles in the seat part of the delivery bed and push it towards the seat part **(1)** until you hear a click **(2)**!

- ▶ Then make sure the lock lever is in the down position **(2)**

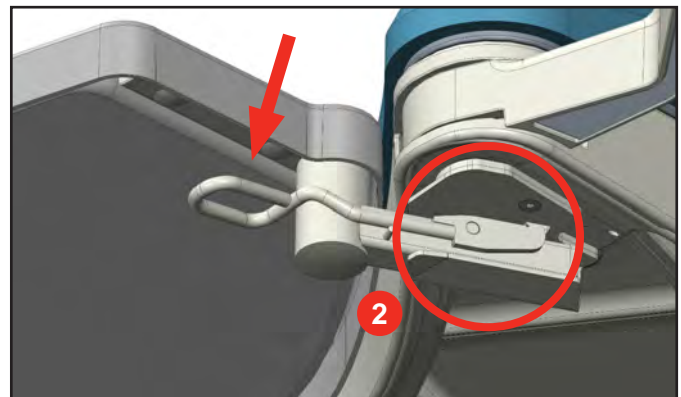
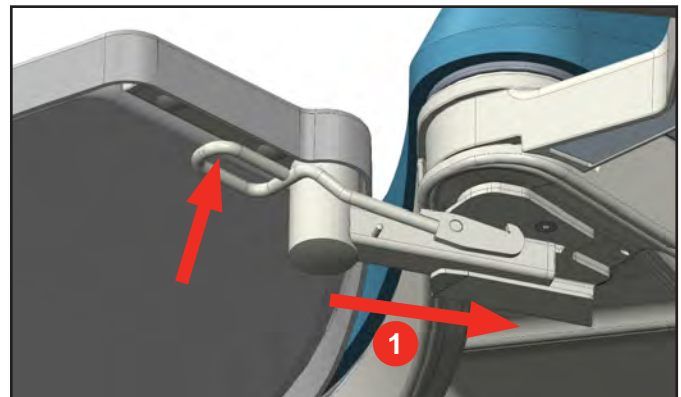

Procedure for dismounting the baby plate from the delivery bed

- ▶ Remove the baby plate in the reverse order of installation
- ▶ When removing the baby plate from the delivery bed, the locking levers must be moved to the unlocked position in the direction of the arrow **(1)**
- ▶ Then slide the baby plate out of the handles on the seat part of the bed towards you **(2)**

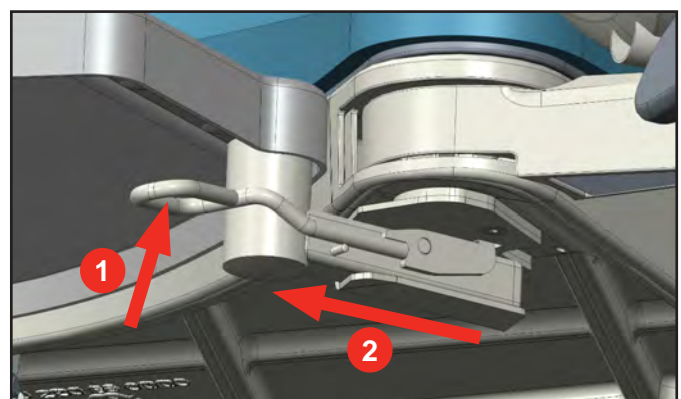

10.22 USB cell-phone recharger



WARNING!

Risk of injury due to improper use!

- ▶ Make sure that the accessories attached to the USB connector are intact. The user of the bed is responsible for meeting this requirement



WARNING!

Risk of injury due to pinched power cord!

- ▶ Make sure that the power cord of the attached accessories is not pinched by the siderail or the parts of the backrest section! The user of the bed is responsible for meeting this requirement



WARNING!

Risk of damage to property due to improper use!

- ▶ Make sure that the attached accessories do not fall down! The user of the bed is responsible for meeting this requirement



WARNING!

Risk of damage to property due to improper use!

- ▶ Never connect any heating element to the USB connector! The user of the bed is responsible for meeting this requirement

The USB charger is used for charging cell phones and tablets. It is located on the back side of the back rest on the left side of the bed.

The USB connector has a plastic cover providing an IP protection for the USB connector. When cleaning the bed, this cover needs to be closed to avoid water getting into the connector.

NOTE Maximum current for this device is 2 A

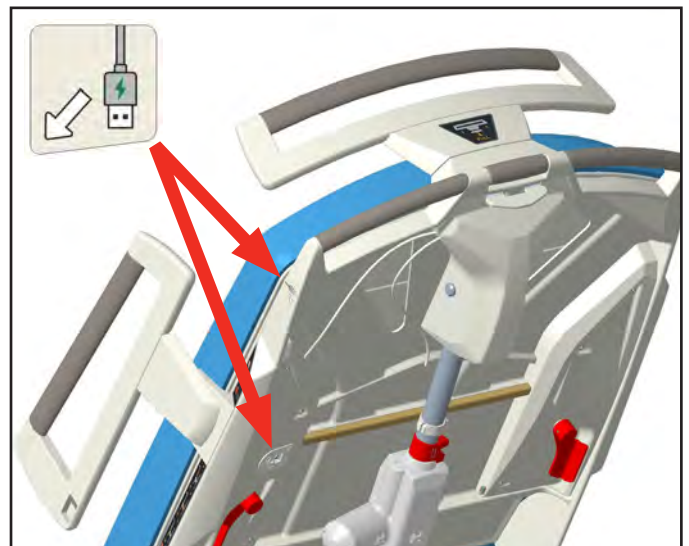
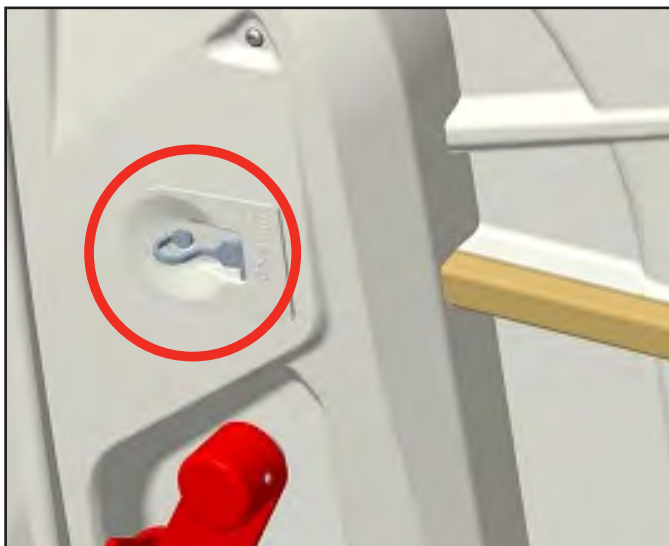

11 Cleaning and disinfection

All BORCAD Medical a.s. products are designed for many years of service under the conditions of correct use. Please use your bed and its accessories carefully.

Please follow these instructions for use and recommended operation and maintenance instructions. Avoid negligent handling. Do not, in case of a function failure, undertake any repairs and never use force!



WARNING!

Do not use any automated cleaning or disinfection methods!

- ▶ For basic cleaning use a soft cloth and only a pH-neutral detergent solution of an multi-purpose cleaner



WARNING!

For disinfection, we recommend using standard preparations for disinfection of surfaces based on for example quaternary ammonia compounds, peroxy-compounds. The dilution ratio recommended by the Manufacturer of these products must be followed at all times!



WARNING!

Do not use any abrasive washing aids or ketone based solvents



WARNING!

By using too much cleaner you risk water leakage into the motor parts of the product, which may damage the electric wiring and render the product not functional



WARNING!

Ensure that disinfectants are selected and applied exclusively by qualified hygiene experts.



WARNING!

In case of improperly performed cleaning and disinfection, there is a risk of nosocomial infection



WARNING!

Put the upholstery on dry bed areas only



WARNING!

This medical device with all its parts and accessories is not designed to undergo sterilization



WARNING!

BORCAD Medical a.s. is not responsible for damage to the cushioning (e.g. cracking, paint flaking etc.), which would result from improper use of disinfectants. In such cases, warranty claim shall not apply



WARNING!

Discoloration of the upholstery due to the transfer of color pigment from clothing or other products coming into contact with the surface (e.g. jeans pants) is not a sign of reduced quality of the leatherette and this discoloration cannot be claimed under warranty

According to the principles of good hygienic practice, the cleaning and disinfection of the delivery room, its equipment and all the medical devices used, must be made directly and promptly after the delivery (birth) in order to prepare the equipment for a new delivery. These principles apply also to the cleaning and disinfection of the delivery bed. All parts of the delivery bed must be cleaned. The procedure must be verified and/or supplemented to be in compliance with the respective hospital guidelines, recommended hygiene rules and implemented procedures. After a bed has been used by a patient with infectious disease, the cleaning and disinfection of the bed must be done in accordance with valid and agreed hospital rules and implemented procedures. To reduce the risk of infection transmission, the pre-treated protective covering drapes and/or covering fabrics must be used, to avoid the contact of the skin of a woman in labour with the upholstery of the components of the delivery bed - seat, back, foot part and footrests.

11.1 Cleaning the birthing bed



WARNING!

Risk of injury due to accidental chair movement!

- ▶ Always disable the function buttons when cleaning between the undercarriage and mattress support platform



WARNING!

Risk of property damage caused by improper cleaning/disinfection!

- ▶ Check if used cleaning agents and disinfectants are compatible with materials that the product consists of! For information see the following table:

| BED COMPONENTS THAT ARE INTENDED TO BE CLEANED | MATERIALS USED (SURFACES OF THE MENTIONED BED COMPONENTS) |
|--|---|
| Undercarriage construction, frame construction, leg rest bracket, foot section mechanism | Lacquered steel |
| Column | Anodized aluminum alloy, Lacquered anodized aluminum alloy |
| Construction of the seat section surface, foot section surface, leg rest surface | Comaxitized aluminum alloy |
| Back section construction | Comaxitized aluminum alloy, polyurethane foam (PUR) |
| Upholstery of the seat, back and foot section, head rest, leg rests | polyvinylchloride (PVC), Silicone |
| Undercarriage cover, back section cover | Akrylonitrilbutadienstyren (ABS) |
| Castors | Polyurethane foam (PUR), polypropylen (PP) |
| Break pedals | Polyamide (PA6), Lacquered steel |
| Bed-head, Side rails | Lacquered aluminium, Polyurethane foam (PUR), Lacquered steel |
| Corner bumpers | Polypropylene (PP) |
| CPR levers | Lacquered steel |
| Leg rest tray | Polyurethane foam (PUR), Lacquered steel |
| Hand controller | Akrylonitrilbutadienstyren (ABS), Polyethylene (PE) |
| Labels | Polyethylene terephthalate (PET) |
| Drives | Polyamide 6 (PA6), Aluminium (Al) |
| Bowl | Stainless steel |
| Foil controllers | Polyethylene (PE) |
| Grab handles foldable, grab handles | Lacquered steel, PVC |
| Supporting bar | Lacquered steel, PVC |
| Accessory holder | Lacquered steel, PVC |

| BED COMPONENTS THAT ARE INTENDED TO BE CLEANED | MATERIALS USED (SURFACES OF THE MENTIONED BED COMPONENTS) |
|--|---|
| Baby plate | Akrylonitrilbutadienstyren (ABS), galvanized steel, stainless steel |
| Eurolaths | Stainless steel |

Bed cleaning procedure:

- ▶ Supporting area including the head pillow starting from the head section toward the lower section
- ▶ Hangers and hand grips
- ▶ Side protections with integrated controls and hand switch
- ▶ Frame of the bed including integrated controls and rear panel
- ▶ Foot section and footrests as well as adjoining plastic elements



- ▶ Bottom side of the upholstery (lift up the upholstery)



- ▶ Bed frame / supporting structure - completely from the head rest part to the sitting part
- ▶ Lift the chassis to the highest position, pull out the mains plug

- ▶ Lift the right chassis plastic cover and clean dirty areas



- ▶ After lifting the left cover, you can lift the right plastic cover as well and clean the chassis. Make sure not to interfere with the electronics. After cleaning, first fit the right cover, then the left cover.



- ▶ Infusion stand and holder

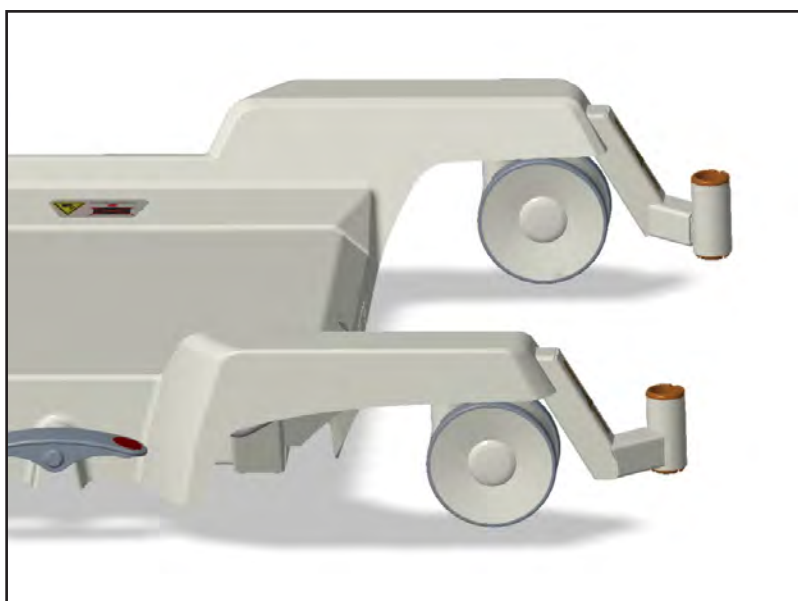

- ▶ Collecting tray (can be cleaned thermally, as stainless steel)



- ▶ Castors and brake pedals

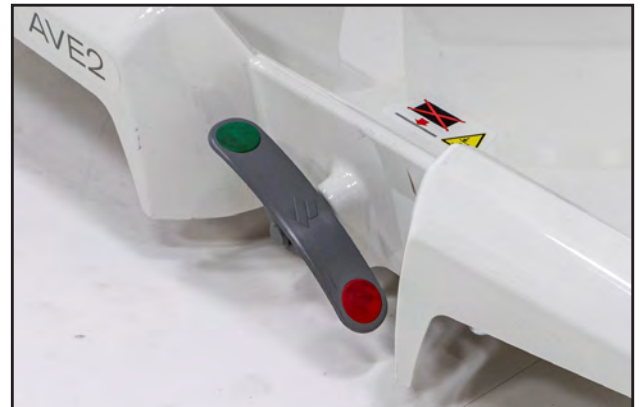

11.1.1 Recommended disinfection (disinfectants for wiping)



WARNING!

Do not use disinfectants with active substance: alcohol over 30%, active chlorine, iodine, aldehydes

| RTU- Ready-to-use non-diluted products - spray or foam | | |
|---|---|--------------------------------|
| Active substance | How to use | Example of disinfectant |
| Amine, Alcohol up to 30% | Spray and wipe | Incidin foam |
| Hydrogen Peroxide | Spray and wipe | Incidin OxyFoam S |
| Alcohol till 30% | Spray and wipe | Bacillol 30 Foam |
| Disinfection wipes | | |
| QAS | Wipe | Sani cloth active |
| Hydrogen Peroxide | Wipe | Incidin OxyWipe S |
| Amine, Alcohol up to 30% | Wipe | Bacillol 30 tissues |
| Concentrated disinfectants, to be diluted | | |
| Active substance | Concentration of the prepared solution of the disinfectant | Example of disinfectant |
| Glukoprotamine | 0,5% | Incidin plus |
| Amine, QAS | 0,5-1% | Terralin protect |
| Oxygen, QAS | 1% | Desam OX |
| Oxygen, QAS | 1% | Incidin Oxydes |
| Amine, QAS | 0,5% | Incidin pro |
| Amine, QAS | 0,5% | Surfanios premium |
| Oxygen | 0,5% | Anios Oxy Floor |
| Oxygen | 1% | Incidin Active |
| Oxygen | 1% | Perform |

11.2 Cleaning the leatherette upholstery



WARNING!

Risk of property damage caused by improper cleaning/disinfection!

- ▶ Always wipe and dry the leatherette upholstery before putting it back into service, even if the cleaner instructions say that this is not required.
- ▶ **Put the upholstery on dry bed areas only!**

| Parts of the leather upholstery that need to be cleaned | Recommended Cleaning Agents (General cleaning) |
|---|---|
| Upholstery of the back and seat section (including head rest), upholstery of the foot section, upholstery of the leg rests. | For general cleaning and superficial dirt, use a disposable wipe with a solution of warm water and neutral detergent. Do not use abrasive or phenolic-based cleaners. Cleaning by neutral water and soap, followed by rinsing with water, is sufficient to clean this product. Solvent containing alcohol, bleaching or abrasive products can be harmful. |
| | Decontamination: Blood spills/Clostridium difficile etc. |
| | See chapter "11.1.1 Recommended disinfection (disinfectants for wiping)" |
| Underside of the back and seat upholstery, underside of the foot section upholstery. | See the procedures above |

In order to preserve the life of leather upholstery, we recommend the following cleaning and disinfection steps:

- ▶ Check the upholstery for any signs of damage.
- ▶ If the upholstery is damaged, replace it.
- ▶ Clean the upholstery with a soft cloth containing a solution of all-purpose neutral detergent in warm water.
- ▶ Let the upholstery air dry or wipe it dry.
- ▶ Disinfect the upholstery with recommended disinfectant.
- ▶ Wipe the upholstery with a cloth soaked in cold water.
- ▶ Let the upholstery air dry or wipe it dry.

11.2.1 Recommended disinfection of leatherette upholstery

To disinfect the leatherette upholstery, the disinfectant listed in chapter "11.1.1 Recommended disinfection (disinfectants for wiping)" can be used.

11.3 Cleaning the DUOCOAT mattress set



WARNING!

Risk of property damage caused by improper cleaning/disinfection!

- ▶ Always wipe and dry the DUOCOAT mattress set before putting it back into service, even if the cleaner instructions say that this is not required
- ▶ **Put the mattress set on dry bed areas only**

General guidance:

- ▶ Do not use any strong acids or alkalines, (optimum pH range 6 – 8. Do not exceed pH of 9). Some hard surface cleaners have pH values outside this range, these are not suitable for use on coated textiles.
- ▶ Only use detergents that are suitable for cleaning medical equipment and for use on coated textiles.
- ▶ Do not use abrasive powders, steel wool, or other material and cleaning agents that might damage the mattress. Do not scrub mattress surface.
- ▶ Never use any corrosive or caustic detergents.
- ▶ Never use detergents that deposit calcium carbonate.
- ▶ Never use detergents with solvents that might affect the structure and consistency of the plastics (benzene, toluene, acetone, phenol, etc.).
- ▶ Use only hospital-approved cleaners and observe local directives concerning infection control.
- ▶ Always rinse with water after cleaning and dry thoroughly before use.

| Mattress parts to be cleaned | Recommended Cleaning Agents (General cleaning) |
|---|--|
| Top Cover (back and seat section, foot section, leg rests) | For general cleaning and superficial dirt, use a disposable wipe with a solution of warm water and neutral detergent. Do not use abrasive or phenolic-based cleaners. Cleaning by neutral water and soap, followed by rinsing with water, is sufficient to clean this product. Solvent containing alcohol, bleaching or abrasive products can be harmful. |
| | Decontamination: Blood spills/Clostridium difficile etc. |
| | Chlorine based disinfectants: <ul style="list-style-type: none"> ▶ For routine decontamination, use a concentration of 5,000 ppm chlorine ▶ In case of heavy contamination, a concentration of up to 10,000 ppm chlorine can be used Dwell time on surface at 10,000 ppm of 2 minutes, followed by rinsing with water and drying thoroughly before use. PU coated fabrics may feel dry to the touch, but still retain moisture. Wait until the surface is no longer cold to the touch before putting PU coated fabrics back into service. |
| Inner covers (foam core covers of the back and seat section and footrest) | Recommended Cleaning Agents (General cleaning) |
| | See the procedure above. |
| | Decontamination: Blood spills/Clostridium difficile etc To disinfect in situ, use a 0.5% sodium hypochlorite solution (5,000 ppm chlorine). Thoroughly rinse the cover with clean water and allow drying before re-use or storage. If the inner cover is heavily soiled, do not use the mattress and contact the service department. |

As stated above, after application of a suitable cleaner, the surface must be rinsed with water and dried before use. (Even if the cleaner instructions say that this is not required). This prevents a build up of chemicals on the mattress surface which could be reactivated during use and affect biocompatibility and durability.

NOTE Continued use of high concentration, chlorine-based disinfectants may significantly reduce the performance and the working life of a coated material.

| Type of Cleaning | Parts to be cleaned |
|-----------------------------------|--|
| Routine Cleaning and Disinfection | <ul style="list-style-type: none"> Exposed mattress parts |
| Full Cleaning and Disinfection | <ul style="list-style-type: none"> Exposed mattress parts Internal cover |

11.3.1 Recommended manual cleaning and disinfection of the top cover



WARNING!

Risk of infection from the inside of the mattress!

- ▶ Check the top of the mattress cover for any signs of damage. If the top cover is damaged, do not use the mattress and contact the service department
- ▶ Check the inside of the top of the mattress cover for signs of liquid ingress. If there is moisture on the inside, replace or clean and completely disinfect the top of the cover

To maintain the life of the mattress, we recommend following these cleaning and disinfection steps. These instructions are also given on the mattress print:

| | |
|--|--|
| | <p>Step 1. Clean the top and bottom of the mattress with a soft cloth with a solution of universal neutral cleaning detergent.</p> |
| | <p>Step 2. Allow the mattress to dry or wipe it dry with a soft cloth</p> <p>Step 3. Disinfect the mattress with sodium hypochlorite solution or recommended disinfection listed in chapter "11.3.3 Recommended chemical concentrations for disinfection the top cover".</p> |
| | <p>Step 4. Rinse with water</p> <p>Step 5. Allow the mattress to dry or wipe it dry with a soft cloth</p> |

11.3.2 Recommended cleaning of the top cover in an industrial laundry



WARNING!

- ▶ The mattress cannot be used if there are no fixing pins on it.
- ▶ Do not bleach the mattress cover!
- ▶ Observe the recommended setting of the industrial washing machine.
- ▶ The cover is not intended for washing in a continuous industrial washing machine.
- ▶ **Foam core covers are not intended for washing in industrial laundries.**

PROCEDURE FOR REMOVING THE TOP COVER FROM THE MATTRESS

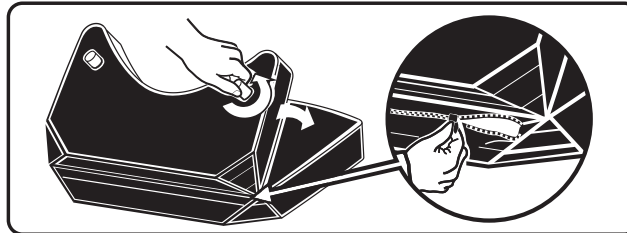

Step 1. Turn the seat section of the mattress to the back part.



Step 2. Unscrew the two plastic pins and remove them, including the plastic washers.



Step 3. Carefully unzip the seat section cover.



Step 4. Turn the back section of the mattress to the seat section.



Step 5. Carefully unzip the back section cover.



Step 6. Turn the foot section with the plastic pins upwards.



Step 7. Unscrew the four plastic pins on the foot section and remove them, including the plastic washers.



Step 8. Carefully unzip the zipper of the top cover of the foot section.

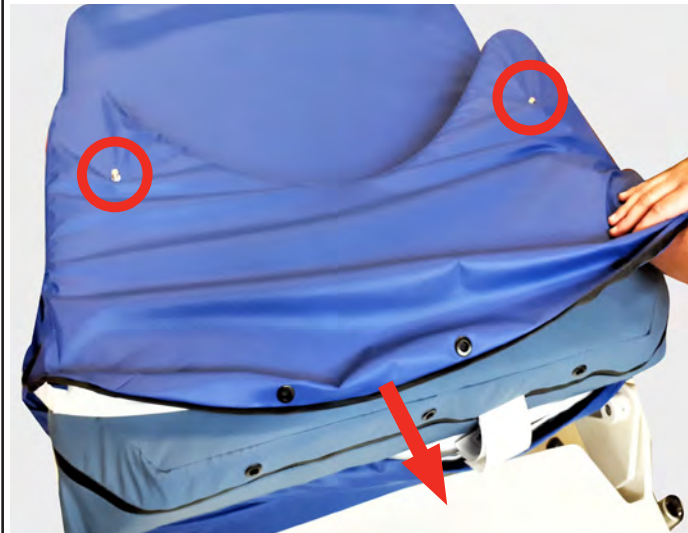

Step 9. Carefully remove the seat core from the mattress cover. **Pull the mattress cover over the screws while pulling out the core.** Inspect the core for damage or contamination.



Step 10. Carefully remove the back core from the mattress cover. Inspect the core for damage or contamination.



Step 11. Carefully remove the core of the foot section from the top cover. Pull the top cover over the screws while removing the core. Inspect the core for damage or dirt.

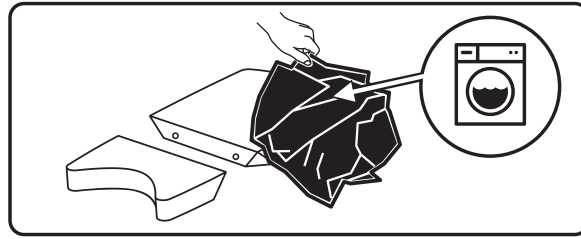

Step 12. The removed cover is washed according to the instructions for the industrial laundry.

Pull the cleaned mattress cover and the footrest cover over again according to the instructions, from Step 11 - to Step 1

RECOMMENDED SETTING OF THE INDUSTRIAL WASHING MACHINE



WARNING!

► The cover is not intended for washing in a continuous industrial washing machine.

Due to the variety of laundry equipment, chemicals and conditions in use, customers should satisfy themselves through pre-testing. It is essential that articles be thoroughly rinsed and dried after all cleaning procedures and before storage or reuse. Wet or damp PU surfaces are more prone to mechanical damage than when dry.

| | | | WASHING PROGRAM | |
|------------------|--------------------|----|-----------------|--------|
| | | | 9N^H | 7N^H |
| Washing | Temperature [°C] | a | 92 ± 3 | 70 ± 3 |
| | Bath level [mm] | b | 100 | 100 |
| | Washing time [min] | d | 15 | 15 |
| | Cooling [-] | f | Yes | Yes |
| Rinsing 1 | Bath level [mm] | b | 130 | 130 |
| | Rinsing time [min] | dg | 3 | 3 |
| Rinsing 2 | Bath level [mm] | b | 130 | 130 |
| | Rinsing time [min] | dg | 3 | 3 |
| | Spin time [min] | d | - | - |
| Rinsing 3 | Bath level [mm] | b | 130 | 130 |
| | Rinsing time [min] | dg | 2 | 2 |
| | Spin time [min] | d | - | - |
| Rinsing 4 | Bath level [mm] | b | 130 | 130 |
| | Rinsing time [min] | eg | 2 | 2 |
| | | d | 5 | 5 |

LEGENDA

| | |
|----------|--|
| N | Normal movement: 12 s rotation and 3 s rest phase |
| a | The basic washing temperature refers to the temperature at which the heating is switched off |
| b | The bath level is measured from the bottom of the tank after 1 min. of washing machine operation and 30 s of the rest phase |
| d | A tolerance of 20 s is allowed for the rest phases |
| e | No movement during heating until it reaches the set temperature -5 ° C. From the set temperature -5 ° C until the set temperature is reached, a slight movement is performed |
| f | Cooling: topping up with cold water to a bath level of 130 mm and operation for another 2 min |
| g | The rinsing time is measured after reaching the bath level |
| h | Heating to 40 ° C, maintained for 15 min. while operating before heating to the washing temperature |

11.3.3 Recommended chemical concentrations for disinfection the top cover



WARNING!

- Do not use disinfectants with active substance: alcohol over 70 %, active chlorine over 10,000 ppm, iodine, aldehydes and phenols

| Active substance | Concentration | pH range | Dwell time | Post application | Recommendations for use |
|-------------------------------|--------------------|-----------|---|-------------------------------------|---|
| Chlorine and compounds | 1 000 - 10,000 ppm | 7 - 9 | <10 mins Strength and microbial target dependent | Rinse and dry | Acceptable and recommended 1000ppm is appropriate for day to day cleaning. For routine decontamination, use a concentration of 5,000 ppm chlorine, in case of heavy contamination, a concentration of up to 10,000 ppm chlorine can be used. Must be rinsed with clean water and towel dried (avoid harsh abrasion). |
| Alcohol | 70 % | – | 10 mins (max) | Rinse and dry | Acceptable for use and recommended subject to precautions Coating may swell and be prone to damage. Care must be taken until fully dry (~1hr). |
| Glutaraldehyde | 2 % | 7.5 - 8.5 | Temperature dependent | Rinse and dry | Acceptable for use |
| Ethylene Oxide | 3 % | – | >30 mins Temperature dependent | Rinse thoroughly and dry before use | Acceptable for sterilization only Ensure that appropriate sterilization validation has been completed. Requires cleaning afterwards. |

| Active substance | Concentration | pH range | Dwell time | Post application | Recommendations for use |
|-------------------------------------|---------------|----------|-----------------------------------|--------------------|---|
| Hydrogen peroxide | 3 % | 5 - 9 | <5 mins | Rinse well and dry | Acceptable for use Must be fully rinsed. Highly acidic or alkaline peroxides should be avoided as they will damage the coating. |
| Quaternary Ammonium Compounds (QAS) | 3 - 15 % | 7 - 10 | Varies Refer to label guidance | Rinse and dry | Acceptable for use and recommended subject to precautions Some Quaternary Ammonium Compounds are too alkaline. Always check the label first. Quaternary solutions having a pH >10 are not recommended. DO NOT USE QUATs (WIPES) containing sodium hydroxide (NaOH). |
| Peracetic acid | | | | | DO NOT USE |
| Iodophors | | | | | DO NOT USE |
| Phenolics | | | | | DO NOT USE |
| Steam Sterilization | | | | | DO NOT USE |
| Dry heat | | | | | DO NOT USE |

11.3.4 Recommended chemical concentrations for disinfection the inner covers



WARNING!

- ▶ Do not use disinfectants with active substance: alcohol over 30 %, active chlorine over 5 000 ppm, iodine, aldehydes and phenols.

| ACTIVE SUBSTANCE | CONCENTRATION |
|------------------------------|-----------------|
| Amine. Alcohol | up to 30 % |
| Hydrogen Peroxide | 3 % |
| Alcohol | up to 30 % |
| Glukoprotamine | 0.5 % |
| Amine, QAS | 0.5 % |
| Oxygen, QAS | 1 % |
| Oxygen | 1 % |
| Chlorine based disinfectants | up to 5,000 ppm |

11.4 Covering the birthing bed for use



WARNING!

The delivery bed must be protected against excessive dirt by a fabric covering!

11.4.1 How to properly coat bed with hospital bedding

One of the options is using a covering from the operating room, the size of which corresponds to that of the relevant delivery bed section, or with a fabric coating used for standard beds. First of all, the lying section, back section or seat section will be covered, then the entire foot section and foot rests. We recommend covering exposed surfaces (seat section, foot rest) additionally with absorption gauze.



Other examples of correct coating of the bed using hospital coatings before labour are shown below.

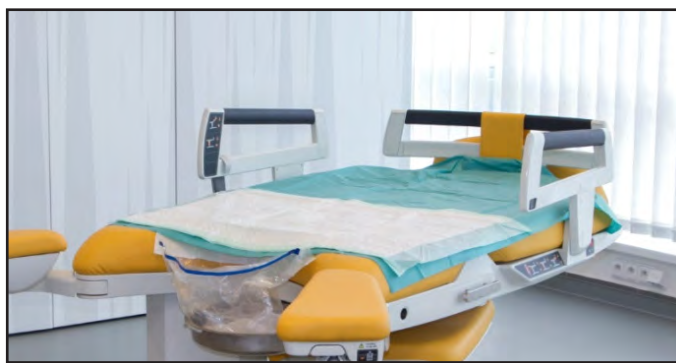

11.4.2 How to properly coat bed with Disposable bed sheets

Special-shape disposable coating materials, designed specifically for AVE2 birthing bed, can also be used:

- ▶ Swing out the back section of the mattress and put the coating on it
- ▶ Then return the back section to its place
- ▶ Lift the seat section and put the coating on it as shown below



- ▶ Then coat the foot rests and the foot section
- ▶ We recommend absorption pad be inserted between the back section and the foot section. The absorption pad can be easily renewed, where necessary



11.4.3 How to properly coat bed with terrycloth

You can also use special-shape terrycloth set directly onto AVE2 birthing bed:

- ▶ Swing out the seat section of the mattress and put the coating on it
- ▶ Return the seat section to its place and lift the back section
- ▶ Put the coating on it as shown below



- ▶ Then coat foot rests and foot section



12 Maintenance



WARNING!

From practical testing results, the technical lifetime of the product is 15 years. Lifetime of the battery is limited and must be replaced.

- ▶ Batteries (these are provided with the warranty of 6 months)
- ▶ Gas springs need to be replaced every 12 years
- ▶ The upholstery is guaranteed for 2 years



DANGEROUS ELECTRIC VOLTAGE!

Within the scope of annual regular revisions of a medical equipment, it is necessary to check the battery voltage (loadless). If the measured value is below 12V (24V in case of measuring two battery cells together), it is necessary to replace the battery immediately

Treads of fastening screws or the joints on the frame parts may get degraded by disinfectants. In these cases, timely lubrication prevents costly repairs.

12.1 List of error, malfunction and generated messages

| Problem description | Likely cause | Action to be taken by the operator to solve the problem | Actions to be taken by the qualified service personnel |
|---|--|--|---|
| The bed is not responding to controller commands. | The bed probably does not have electric supply and the battery is already depleted | Plug the power supply cord to the electric socket (full recharge of the battery takes 8 hours) | Check, if the electric network is on and the socket in function. Use other electric socket |
| The hand controller or some of its buttons are not working | The hand controller cable is not properly inserted in the bed connector | Make sure, the hand controller cable is inserted properly in the bed connector. | Check, if the bed responds with another hand controller. If so, replace the hand controller |
| The function lock indicator is flashing and after pressing any button on the bed, a short alarm signal sounds | Emergency stop device is not working | Calling service | Replacing the DPS controlboard or erasing the error flag using 'r' sent via diagnostics |
| When all functions are actively locked, after pressing any button, a short acoustic signal sounds | Locked buttons | Unlocking buttons of keyboards by holding down the lock button | - |
| The bed emits intermittent acoustic signal and one of the controllers is not functioning | Controller failure | Call the service | Repair of the faulty controller |

12.2 Service and repairs



WARNING!

All service revisions, safety and technical inspections or service interventions must be executed only by a technician trained by BORCAD Medical a.s. company.

- ▶ Diagrams, lists of product parts, descriptions or other information intended to help the service personnel with the repair of product parts, repairable by the service personnel only as implied by the manufacturer, are available upon demand at the manufacturer.

The product is provided with the warranty period of 2 years on conditions that regular annual service inspections are carried out.

For all medical equipment produced by the BORCAD Medical a.s. company, the operator must ensure regular technical safety inspections according to the Manufacturer's recommendation, thus the inspections must take place at least 1x per year or after the carrying out of any repair of the medical equipment or after any intervention regarding the electrical system of the medical equipment. The details about the scope, parameters and procedures of the technical safety inspection are specified in the service manual of the medical equipment.

In case the product is not functioning, please contact the product dealer in your country. In case of any other problems, please contact (preferably in English) the manufacturer at:

BORCAD Medical a.s.

Fryčovice 673

739 45 Fryčovice

Czech Republic

Tel: +420 736 628 231

Fax: +420 558 668 087

e-mail: service@borcadmedical.com

For repairs, please use only the original BORCAD Medical a.s. spare parts and the services of trained service technicians licensed to repair products of this type. Unprofessional repairs shall be considered as a substantial breach of the warranty terms and conditions and the manufacturer simultaneously does not bear any responsibility for any further possible damage to the product which might result from unprofessional intervention.

13 Environmental protection and liquidation of the product

Company BORCAD Medical a.s. is aware of the important role that the protection of the environment plays for future generations. Therefore, it focuses closely on the development, innovation and production of such technologies and materials that preserve the environment. BORCAD Medical a.s. complies with the EU directive on limiting usage of certain hazardous substances in electric, as well as electrical products.

The materials of this product are environmentally friendly. It does not contain hazardous substances on the basis of cadmium, mercury, asbestos, PCB or CFC. Noise emissions of the product meet the requirements on the protection of public health against harmful effects of noise and vibrations inside protected buildings.

All waste material after the installation of the product in operation is marked in accordance with the respective valid regulations on packaging material. After installing the product, BORCAD Medical a.s. company sorts out the packaging material according to corresponding pictograms and disposes of it by means of an authorized waste material disposing entity. For the free-of-charge waste material take back, please contact BORCAD Medical a.s. sales representative or service technician. Sort out the packaging waste material after putting the product in operation in accordance with the pictograms and deliver it to an authorised person for further use.

The product consists of recyclable steel, plastic and electronic components. For the purposes of optimum recycling, sort out the individual parts of the product when the lifetime of the product comes to an end in a way so that they might be further used as material from which the product had been manufactured (see diagrams below).

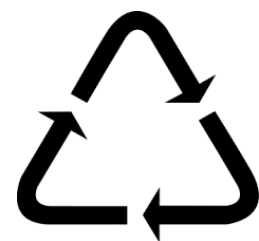
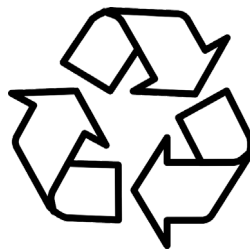

Acu / battery

Accumulators can be disposed of by a local waste material disposal system. Carry out the disposal of the material in accordance with local waste material regulations (expert personnel, assistance obligatory). Before disposal clean and disinfect the product properly. By proper disposal of the product, you will help to preserve precious natural resources and prevent potential negative effects on the environment and human health, which may result from improper disposal of waste materials. For more details please contact competent environmental authorities, or the nearest disposal hub for recycled waste material.

14 List of available equipment

| N (BASIC VERSIONS) | |
|--|--|
| PPB-AX Birthing bed AVE2: | |
| Standard leg rests + leg straps (pair) | |
| Backup battery | |
| Sliding foot section including the upholstery | |
| Seamless mattress | |
| Manual CPR | |
| Infusion stand holder on both sides of the bed | |
| Side rail with controls | |
| Fixed panel with controls | |
| Handgrifts (pair) | |
| Castors 150mm, 1 x directional | |
| Central brake | |
| Equipotential busbar | |
| Network cable of one's choice | |
| Choice from standard color options | |
| Packaging | |

| B (POWER CABLE): | |
|-------------------------|---|
| PPB-050.37 | Electric cable JAR - spiral, 4m, orange |
| PPB-050.30 | Electric wire IZR - straight, 3,5m, orange |
| PPB-050.31 | Electric cable EU - spiral, 4m, orange |
| PPB-050.32 | Electric cable USA - straight, 4m, orange |
| PPB-050.33 | Electric wire CH - spiral, 4m, orange |
| PPB-050.35 | Electric cable UK - spiral, 4m, orange |
| PPB-050.40 | Electric cable ITA - spiral, 4m, orange |
| PPB-050.38 | Electric cable AUS - spiral, 4m, orange |
| PPB-050.39 | Electric cable BRA - straight, 4m, black |
| PPB-050.36 | Electric cable ITA - spiral, angled, 4m, orange |

| N (ELECTRICAL SYSTEM): | |
|-------------------------------|----------------------------------|
| PPB-050.21 | 220-240 VAC - Electric equipment |
| PPB-050.22 | 110-120 VAC - Electric equipment |
| PPB-050.23 | 100 VAC - Electric equipment |
| PPB-050.24 | 127 VAC - Electric equipment |

| N (MATTRESS THICKNESS): | |
|--------------------------------|----------------------|
| PPB-014-X | 100 mm |
| PPB-080-X | 130 mm |
| PPB-083-X | 100 mm with a zipper |
| PPB-081-X | 130 mm with a zipper |

| A (COLOR): | |
|-------------------|---------------------------|
| A | Violet F4340-50621 |
| B | Blue F4340_07459 |
| F | Green F4340-20157 |
| M | Yellow F4340_07477 |
| P | Orange F4340_20127 |
| X3 | Own choice of leatherette |
| | F4340_00002 |
| | F4340_07422 |
| | F4340_07432 |
| | F4340_07436 |
| | F4340_07445 |
| | F4340_07476 |
| | F4340_07478 |
| | F4340_07479 |
| | F4340_07480 |
| | F4340_07485 |
| | F4340_07496 |
| | F4340_10120 |
| | F4340_10295 |
| | F4340_20129 |
| | F4340_20130 |
| | F4340-5015 |
| | F4340-5347 |
| | F4340-20150 |
| | F4340-20154 |
| | F4340-20156 |
| | F4340-20161 |
| | F4340-20162 |
| | F4340-50454 |
| | F4340-50618 |

A (COLOR):

| | |
|----------|------------------|
| | F4340-50619 |
| | F4340-50620 |
| | F4340-50622 |
| | F4340-50623 |
| T | Pink F4340-20149 |

N (UPHOLSTERY):

| | |
|---------------------|---|
| PPB-006.07-X | PPB-006.07 Upholstery of the footrest |
| PPB-007.03-X | PPB-007.03 Upholstery of the right leg holder |
| PPB-008.03-X | PPB-008.03 Upholstery of the left leg holder |

N (NURSE CALL)

| | |
|----------------|---------------|
| PPB-046 | Nurse Call |
| PPB-047 | NO Nurse Call |

N (FOOTREST)

| | |
|----------------|-------------------------------|
| PPB-076 | Set of leg rests (US) |
| PPB-075 | Set of leg rests (outside US) |

N (STICKERS)

| | |
|-----------------|-------------------------------|
| D6020418 | Self-adhesive label L I N E T |
|-----------------|-------------------------------|

N (MANDATORY SELECTION)

| | |
|-------------------|-----------------------------|
| PPB-067-X | Supporting bar |
| PPB-062 | Hand controller |
| PPB-064 | Eurobar |
| PPB-065 | Without eurolath |
| PPB-070.01 | Overlay for 100 mm mattress |
| PPB-066.01 | Overlay for 130 mm mattress |
| PPB-060 | With Headboard |
| PPB-072 | With covers of Heaboard |

N (PACKAGING)

| | |
|----------------|--|
| PPB-090 | Cartonbox on palette with indicator |
| PPB-091 | Overseas packaging without indicator |
| PPB-092 | Reinforced cartonbox on palette with indicator |

N (PACKAGING)

| | |
|---------|------|
| PPB-093 | Foil |
|---------|------|

N (OPERATIONAL MANUALS)

| | |
|-------|-------------|
| 84660 | PPB-072-CZ |
| 84664 | PPB-072-DE |
| 84666 | PPB-072-EN |
| 84668 | PPB-072-ES |
| 84670 | PPB-072-FR |
| 84672 | PPB-072-IT |
| 84678 | PPB-072-SWE |
| 87892 | PPB-073-US |
| 87795 | PPB-072-NL |
| 87894 | PPB-073-CAN |

N (OPTIONAL)

| | |
|---------------|---|
| PPB-069 | Front holder of accessories |
| GKB-076.X | Doctor's chair - ergonomic |
| PPA-36 | Telescopic infusion stand |
| ZK-05.X | Doctor's chair |
| PPA-33 | Large stainless steel bowl - 10 l |
| PPB-034 | Stainless steel bowl - 8 l |
| PPB-009 | Bowl holder |
| PPB-014.03-X3 | Head rest |
| PPB-077 | Front bumper fitted on the leg rest (R/L) |
| PPA-10 | Sliding stainless catch basin 4.5 l |
| PPB-CCC | Under carriage light |
| PPB-012 | Set of Hand Grips (removable) |
| PPB-013 | Set of Hand Grips (foldable) |

N (OVERLAYS)

| | |
|-----------|--|
| PPB-100-A | Terry bed clothes – white |
| 832 | Non-sterile absorbent non-permeable pad |
| 874 | STANDARD Non-sterile non-permeable supporting area cover |
| 875 | STANDARD Non-sterile non-permeable foot section cover |
| 876 | STANDARD Non-sterile permeable leg rest cover |

N (OVERLAYS)

| | |
|-----|---|
| 877 | COMFORT Non-sterile non-permeable supporting area cover |
| 878 | COMFORT Non-sterile non-permeable foot section cover |
| 879 | COMFORT Non-sterile permeable leg rest cover |

N (SELECTION OF CASTORS)

| | |
|---------|----------------------------------|
| PPB-478 | Standard castors (150 mm) |
| PPB-479 | Castors with longer pin (150 mm) |